



IEI Technology Corp.



MODEL:  
**ECN-780-Q67**

Embedded System with 2nd Gen Intel® Core™  
i7/i5/i3 Desktop Processors, DVI, HDMI, VGA, GbE,  
Two USB 3.0, Two USB 2.0, Three COM and RoHS Compliant

## User Manual

Rev. 1.02 – 12 September 2012



# Revision

---

Date	Version	Changes
12 September 2012	1.02	Update the pictures of rear panel and front panel
6 June 2012	1.01	Update the pictures of rear panel
6 April 2012	1.00	Initial release

# Copyright

---

## COPYRIGHT NOTICE

The information in this document is subject to change without prior notice in order to improve reliability, design and function and does not represent a commitment on the part of the manufacturer.

In no event will the manufacturer be liable for direct, indirect, special, incidental, or consequential damages arising out of the use or inability to use the product or documentation, even if advised of the possibility of such damages.

This document contains proprietary information protected by copyright. All rights are reserved. No part of this manual may be reproduced by any mechanical, electronic, or other means in any form without prior written permission of the manufacturer.

## TRADEMARKS

All registered trademarks and product names mentioned herein are used for identification purposes only and may be trademarks and/or registered trademarks of their respective owners.

# Table of Contents

---

<b>1 INTRODUCTION.....</b>	<b>1</b>
1.1 OVERVIEW.....	2
1.2 MODEL VARIATIONS .....	2
1.3 FEATURES.....	2
1.4 TECHNICAL SPECIFICATIONS .....	3
1.5 FRONT PANEL.....	5
1.6 REAR PANEL.....	5
1.7 DIMENSIONS.....	7
<b>2 UNPACKING .....</b>	<b>8</b>
2.1 ANTI-STATIC PRECAUTIONS .....	9
2.2 UNPACKING PRECAUTIONS.....	9
2.3 UNPACKING CHECKLIST .....	10
<b>3 INSTALLATION .....</b>	<b>12</b>
3.1 INSTALLATION PRECAUTIONS .....	13
3.2 INSTALLATION AND CONFIGURATION STEPS .....	13
3.3 HARD DISK DRIVE (HDD) INSTALLATION.....	13
3.4 AT/ATX MODE SELECTION .....	15
3.4.1 AT Power Mode.....	16
3.4.2 ATX Power Mode .....	16
3.5 RESET THE SYSTEM .....	17
3.6 POWERING ON/OFF THE SYSTEM .....	17
3.7 MOUNT THE SYSTEM.....	18
3.7.1 Mounting the System with Mounting Brackets.....	19
3.8 EXTERNAL PERIPHERAL INTERFACE CONNECTORS.....	20
3.8.1 Audio Connection.....	21
3.8.2 DVI Display Device Connection.....	22
3.8.3 HDMI Device Connection.....	23
3.8.4 LAN Connection.....	24
3.8.5 DB-9 Serial Port Connection.....	25



3.8.6	<i>USB Device Connection</i> .....	26
3.8.7	<i>VGA Monitor Connection</i> .....	27
3.9	INTEL® AMT SETUP PROCEDURE.....	28
<b>4</b>	<b>SYSTEM MOTHERBOARD</b> .....	<b>30</b>
4.1	OVERVIEW.....	31
4.1.1	<i>Layout</i> .....	31
4.1.2	<i>Motherboard Dimensions</i> .....	32
4.1.3	<i>Peripheral Interface Connectors</i> .....	33
4.2	INTERNAL PERIPHERAL CONNECTORS .....	34
4.2.1	<i>Battery Connector</i> .....	34
4.2.2	<i>BIOS Programming Connector</i> .....	35
4.2.3	<i>Digital I/O Connector</i> .....	36
4.2.4	<i>EC Programming Connector</i> .....	37
4.2.5	<i>Fan Connector (System)</i> .....	38
4.2.6	<i>Keyboard/Mouse Connector</i> .....	39
4.2.7	<i>LED Module Connector</i> .....	40
4.2.8	<i>PCIe Mini Card Slot</i> .....	41
4.2.9	<i>Power Connector</i> .....	42
4.2.10	<i>RS-232 Serial Port Connectors</i> .....	43
4.2.11	<i>RS-422/485 Serial Port Connector</i> .....	44
4.2.12	<i>SATA Drive Connectors</i> .....	45
4.2.13	<i>SATA Power Connectors</i> .....	46
4.2.14	<i>SMBus Connector</i> .....	47
4.2.15	<i>SO-DIMM Connector</i> .....	48
4.2.16	<i>K Type Thermocouple Connectors</i> .....	49
4.2.17	<i>TPM Connector</i> .....	50
4.2.18	<i>USB 2.0 Connectors</i> .....	51
4.2.19	<i>VGA Connector</i> .....	52
4.3	JUMPER SETTINGS .....	53
4.3.1	<i>Clear CMOS</i> .....	53
4.3.2	<i>Flash Descriptor Security Override</i> .....	54
<b>5</b>	<b>BIOS</b> .....	<b>56</b>
5.1	INTRODUCTION.....	57

5.1.1 Starting Setup.....	57
5.1.2 Using Setup.....	57
5.1.3 Getting Help.....	58
5.1.4 Unable to Reboot after Configuration Changes.....	58
5.1.5 BIOS Menu Bar.....	58
5.2 MAIN.....	59
5.3 ADVANCED.....	60
5.3.1 ACPI Configuration.....	61
5.3.2 RTC Wake Settings.....	62
5.3.3 Trusted Computing.....	63
5.3.4 CPU Configuration.....	64
5.3.4.1 CPU Information.....	65
5.3.5 SATA Configuration.....	66
5.3.6 Intel TXT (LT) Configuration.....	67
5.3.7 USB Configuration.....	68
5.3.8 F81866 Super IO Configuration.....	69
5.3.8.1 Serial Port n Configuration.....	70
5.3.9 F81866 H/W Monitor.....	74
5.3.9.1 Smart Fan Mode Configuration.....	76
5.3.10 Serial Port Console Redirection.....	78
5.3.10.1 Console Redirection Settings.....	79
5.4 IEI FEATURE.....	81
5.5 CHIPSET.....	82
5.5.1 Northbridge Configuration.....	83
5.5.2 Southbridge Configuration.....	84
5.5.3 Intel IGD SWSCI OpRegion.....	86
5.5.4 ME Subsystem.....	87
5.6 BOOT.....	88
5.7 SECURITY.....	90
5.8 EXIT.....	91
<b>6 SOFTWARE DRIVERS.....</b>	<b>93</b>
6.1 AVAILABLE SOFTWARE DRIVERS.....	94
6.2 STARTING THE DRIVER PROGRAM.....	94
6.3 CHIPSET DRIVER INSTALLATION.....	95

6.4 GRAPHICS DRIVER INSTALLATION .....	99
6.5 LAN DRIVER INSTALLATION .....	103
6.6 AUDIO DRIVER INSTALLATION .....	107
6.7 USB 3.0 DRIVER INSTALLATION.....	109
6.8 INTEL® MANAGEMENT ENGINE COMPONENTS INSTALLATION.....	111
<b>A SAFETY PRECAUTIONS .....</b>	<b>116</b>
A.1 SAFETY PRECAUTIONS .....	117
<i>A.1.1 General Safety Precautions .....</i>	<i>117</i>
<i>A.1.2 Anti-static Precautions .....</i>	<i>118</i>
<i>A.1.3 Product Disposal .....</i>	<i>119</i>
A.2 MAINTENANCE AND CLEANING PRECAUTIONS .....	119
<i>A.2.1 Maintenance and Cleaning.....</i>	<i>119</i>
<i>A.2.2 Cleaning Tools.....</i>	<i>120</i>
<b>B BIOS MENU OPTIONS .....</b>	<b>121</b>
<b>C ONE KEY RECOVERY.....</b>	<b>124</b>
C.1 ONE KEY RECOVERY INTRODUCTION .....	125
<i>C.1.1 System Requirement .....</i>	<i>126</i>
<i>C.1.2 Supported Operating System.....</i>	<i>127</i>
C.2 SETUP PROCEDURE FOR WINDOWS .....	128
<i>C.2.1 Hardware and BIOS Setup .....</i>	<i>129</i>
<i>C.2.2 Create Partitions .....</i>	<i>129</i>
<i>C.2.3 Install Operating System, Drivers and Applications.....</i>	<i>133</i>
<i>C.2.4 Building the Recovery Partition.....</i>	<i>134</i>
<i>C.2.5 Create Factory Default Image .....</i>	<i>136</i>
C.3 AUTO RECOVERY SETUP PROCEDURE .....	141
C.4 SETUP PROCEDURE FOR LINUX .....	145
C.5 RECOVERY TOOL FUNCTIONS .....	149
<i>C.5.1 Factory Restore .....</i>	<i>150</i>
<i>C.5.2 Backup System.....</i>	<i>151</i>
<i>C.5.3 Restore Your Last Backup.....</i>	<i>152</i>
<i>C.5.4 Manual .....</i>	<i>153</i>
C.6 RESTORE SYSTEMS FROM A LINUX SERVER THROUGH LAN .....	154
<i>C.6.1 Configure DHCP Server Settings.....</i>	<i>155</i>

<i>C.6.2 Configure TFTP Settings</i> .....	156
<i>C.6.3 Configure One Key Recovery Server Settings</i> .....	157
<i>C.6.4 Start the DHCP, TFTP and HTTP</i> .....	158
<i>C.6.5 Create Shared Directory</i> .....	158
<i>C.6.6 Setup a Client System for Auto Recovery</i> .....	159
<b>C.7 OTHER INFORMATION</b> .....	162
<i>C.7.1 Using AHCI Mode or ALi M5283 / VIA VT6421A Controller</i> .....	162
<i>C.7.2 System Memory Requirement</i> .....	164
<b>D WATCHDOG TIMER</b> .....	165
<b>E HAZARDOUS MATERIALS DISCLOSURE</b> .....	168
<b>E.1 HAZARDOUS MATERIALS DISCLOSURE TABLE FOR IPB PRODUCTS CERTIFIED AS ROHS COMPLIANT UNDER 2002/95/EC WITHOUT MERCURY</b> .....	169



# List of Figures

Figure 1-1: ECN-780-Q67 .....	2
Figure 1-2: ECN-780-Q67 Front Panel.....	5
Figure 1-3: ECN-780-Q67 Rear Panel.....	6
Figure 1-4: Physical Dimensions (mm) .....	7
Figure 3-1: Retention Screws Removal.....	14
Figure 3-2: HDD Bracket .....	14
Figure 3-3: HDD Retention Screws .....	15
Figure 3-4: AT/ATX Switch Location.....	16
Figure 3-5: Reset Button Location.....	17
Figure 3-6: Power Button Location.....	18
Figure 3-7: Mounting Screw Holes.....	18
Figure 3-8: Mounting Bracket Retention Screws .....	19
Figure 3-9: Peripheral Connectors (Front Panel) .....	21
Figure 3-10: Peripheral Connectors (Rear Panel) .....	21
Figure 3-11: Audio Connector .....	22
Figure 3-12: DVI Connector .....	23
Figure 3-13: HDMI Connection .....	24
Figure 3-14: LAN Connection .....	25
Figure 3-15: DB-9 Serial Port Connector.....	26
Figure 3-16: USB Device Connection .....	27
Figure 3-17: VGA Connector .....	28
Figure 4-1: Connector and Jumper Locations (Front Side) .....	31
Figure 4-2: Connector and Jumper Locations (Rear Side).....	32
Figure 4-3: Motherboard Dimensions (Front Side) (mm).....	32
Figure 4-4: Motherboard Dimensions (Rear Side) (mm).....	33
Figure 4-5: Battery Connector Location.....	35
Figure 4-6: BIOS Programming Connector Location.....	36
Figure 4-7: Digital I/O Connector Location .....	37
Figure 4-8: EC Programming Connector Location.....	38
Figure 4-9: System Fan Connector Location.....	39

<b>Figure 4-10: Keyboard/Mouse Connector Location .....</b>	<b>40</b>
<b>Figure 4-11: LED Module Connector Location .....</b>	<b>41</b>
<b>Figure 4-12: PCIe Mini Card Slot Location .....</b>	<b>42</b>
<b>Figure 4-13: Power Connector Location .....</b>	<b>43</b>
<b>Figure 4-14: RS-232 Serial Port Connector Location.....</b>	<b>44</b>
<b>Figure 4-15: RS-232 Serial Port Connector Location.....</b>	<b>44</b>
<b>Figure 4-16: RS-422/485 Serial Port Connector Location.....</b>	<b>45</b>
<b>Figure 4-17: SATA Drive Connector Locations .....</b>	<b>46</b>
<b>Figure 4-18: SATA Power Connector Locations .....</b>	<b>47</b>
<b>Figure 4-19: SMBus Connector Location .....</b>	<b>48</b>
<b>Figure 4-20: SO-DIMM Connector Locations .....</b>	<b>49</b>
<b>Figure 4-21: Type K Thermocouple Connector Locations .....</b>	<b>49</b>
<b>Figure 4-22: TPM Connector Location.....</b>	<b>50</b>
<b>Figure 4-23: USB Connector Locations.....</b>	<b>51</b>
<b>Figure 4-24: VGA Connector Location .....</b>	<b>52</b>
<b>Figure 4-25: Clear CMOS Jumper Location .....</b>	<b>54</b>
<b>Figure 4-26: Flash Descriptor Security Override Jumper Location .....</b>	<b>55</b>
<b>Figure 6-1: Drivers .....</b>	<b>95</b>
<b>Figure 6-2: Chipset Driver Screen.....</b>	<b>96</b>
<b>Figure 6-3: Chipset Driver Welcome Screen.....</b>	<b>96</b>
<b>Figure 6-4: Chipset Driver License Agreement .....</b>	<b>97</b>
<b>Figure 6-5: Chipset Driver Read Me File .....</b>	<b>98</b>
<b>Figure 6-6: Chipset Driver Setup Operations .....</b>	<b>98</b>
<b>Figure 6-7: Chipset Driver Installation Finish Screen.....</b>	<b>99</b>
<b>Figure 6-8: Graphics Driver Read Me File .....</b>	<b>100</b>
<b>Figure 6-9: Graphics Driver Setup Files Extracted .....</b>	<b>100</b>
<b>Figure 6-10: Graphics Driver Welcome Screen .....</b>	<b>101</b>
<b>Figure 6-11: Graphics Driver License Agreement.....</b>	<b>101</b>
<b>Figure 6-12: Graphics Driver Read Me File .....</b>	<b>102</b>
<b>Figure 6-13: Graphics Driver Setup Operations .....</b>	<b>102</b>
<b>Figure 6-14: Graphics Driver Installation Finish Screen .....</b>	<b>103</b>
<b>Figure 6-15: Intel® Network Connection Menu.....</b>	<b>104</b>
<b>Figure 6-16: LAN Driver Welcome Screen .....</b>	<b>104</b>
<b>Figure 6-17: LAN Driver License Agreement.....</b>	<b>105</b>
<b>Figure 6-18: LAN Driver Setup Options.....</b>	<b>105</b>

Figure 6-19: LAN Driver Installation .....	106
Figure 6-20: LAN Driver Installation Complete.....	106
Figure 6-21: Audio Driver Welcome Screen.....	107
Figure 6-22: Audio Driver Installation.....	108
Figure 6-23: Audio Driver Installation Complete .....	108
Figure 6-24: USB 3.0 Driver Welcome Screen .....	109
Figure 6-25: USB 3.0 Driver Choose Install Location .....	110
Figure 6-26: USB 3.0 Driver Choose Install Location .....	110
Figure 6-27: USB 3.0 Driver Installation Complete.....	111
Figure 6-28: Intel® ME Driver Welcome Screen .....	112
Figure 6-29: Intel® ME Driver License Agreement .....	113
Figure 6-30: Intel® ME Driver Read Me File .....	113
Figure 6-31: Intel® ME Driver Setup Operations .....	114
Figure 6-32: Intel® ME Driver Installation Finish Screen .....	115
Figure C-1: IEI One Key Recovery Tool Menu .....	125
Figure C-2: Launching the Recovery Tool .....	130
Figure C-3: Recovery Tool Setup Menu .....	130
Figure C-4: Command Prompt .....	131
Figure C-5: Partition Creation Commands.....	132
Figure C-6: Launching the Recovery Tool .....	134
Figure C-7: Manual Recovery Environment for Windows .....	134
Figure C-8: Building the Recovery Partition.....	135
Figure C-9: Press Any Key to Continue .....	135
Figure C-10: Press F3 to Boot into Recovery Mode.....	136
Figure C-11: Recovery Tool Menu .....	136
Figure C-12: About Symantec Ghost Window.....	137
Figure C-13: Symantec Ghost Path .....	137
Figure C-14: Select a Local Source Drive .....	138
Figure C-15: Select a Source Partition from Basic Drive .....	138
Figure C-16: File Name to Copy Image to .....	139
Figure C-17: Compress Image.....	139
Figure C-18: Image Creation Confirmation .....	140
Figure C-19: Image Creation Complete .....	140
Figure C-20: Image Creation Complete .....	140
Figure C-21: Press Any Key to Continue .....	141

<b>Figure C-22: Auto Recovery Utility .....</b>	<b>142</b>
<b>Figure C-23: Launching the Recovery Tool .....</b>	<b>142</b>
<b>Figure C-24: Auto Recovery Environment for Windows .....</b>	<b>142</b>
<b>Figure C-25: Building the Auto Recovery Partition.....</b>	<b>143</b>
<b>Figure C-26: Factory Default Image Confirmation .....</b>	<b>143</b>
<b>Figure C-27: Image Creation Complete .....</b>	<b>144</b>
<b>Figure C-28: Press any key to continue .....</b>	<b>144</b>
<b>Figure C-29: Partitions for Linux.....</b>	<b>146</b>
<b>Figure C-30: Manual Recovery Environment for Linux .....</b>	<b>147</b>
<b>Figure C-31: Access menu.lst in Linux (Text Mode).....</b>	<b>148</b>
<b>Figure C-32: Recovery Tool Menu .....</b>	<b>148</b>
<b>Figure C-33: Recovery Tool Main Menu .....</b>	<b>149</b>
<b>Figure C-34: Restore Factory Default .....</b>	<b>150</b>
<b>Figure C-35: Recovery Complete Window .....</b>	<b>151</b>
<b>Figure C-36: Backup System.....</b>	<b>151</b>
<b>Figure C-37: System Backup Complete Window .....</b>	<b>152</b>
<b>Figure C-38: Restore Backup .....</b>	<b>152</b>
<b>Figure C-39: Restore System Backup Complete Window .....</b>	<b>153</b>
<b>Figure C-40: Symantec Ghost Window .....</b>	<b>153</b>



# List of Tables

---

<b>Table 1-1: Model Variations .....</b>	<b>2</b>
<b>Table 1-2: Technical Specifications .....</b>	<b>5</b>
<b>Table 2-1: Package List Contents .....</b>	<b>11</b>
<b>Table 4-1: Peripheral Interface Connectors .....</b>	<b>34</b>
<b>Table 4-2: Battery Connector Pinouts .....</b>	<b>35</b>
<b>Table 4-3: BIOS Programming Connector Pinouts .....</b>	<b>36</b>
<b>Table 4-4: Digital I/O Connector Pinouts .....</b>	<b>37</b>
<b>Table 4-5: EC Programming Connector Pinouts .....</b>	<b>38</b>
<b>Table 4-6: System Fan Connector Pinouts .....</b>	<b>39</b>
<b>Table 4-7: Keyboard/Mouse Connector Pinouts .....</b>	<b>40</b>
<b>Table 4-8: LED Module Connector Pinouts .....</b>	<b>41</b>
<b>Table 4-9: Power Connector Pinouts .....</b>	<b>43</b>
<b>Table 4-10: Serial Port Connector Pinouts (COM1, COM2, COM3, COM4 ) .....</b>	<b>44</b>
<b>Table 4-11: RS-422/485 Serial Port Connector Pinouts .....</b>	<b>45</b>
<b>Table 4-12: SATA Power Connector Pinouts .....</b>	<b>47</b>
<b>Table 4-13: SMBus Connector Pinouts .....</b>	<b>48</b>
<b>Table 4-14: Type K Thermocouple Connector Pinouts .....</b>	<b>50</b>
<b>Table 4-15: TPM Connector Pinouts .....</b>	<b>51</b>
<b>Table 4-16: USB Port Connector Pinouts .....</b>	<b>52</b>
<b>Table 4-17: VGA Connector Pinouts .....</b>	<b>52</b>
<b>Table 4-18: Jumpers .....</b>	<b>53</b>
<b>Table 4-19: Clear CMOS Jumper Settings .....</b>	<b>54</b>
<b>Table 4-20: Flash Descriptor Security Override Jumper Settings .....</b>	<b>54</b>
<b>Table 5-1: BIOS Navigation Keys .....</b>	<b>58</b>

Chapter

1

# Introduction

---

## 1.1 Overview



**Figure 1-1: ECN-780-Q67**

The ECN-780-Q67 is an embedded system with one VGA port, one DVI port and one HDMI port for dual display. It is powered by a 2nd generation Intel® Core™ i7/i5/i3, Celeron®, Pentium® desktop processor and uses the Intel® Q67 chipset. It has 2.0 GB DDR3 memory on board and supports one 204-pin 1066/1333 MHz dual-channel DDR3 SDRAM SO-DIMM module up to 10 GB. The ECN-780-Q67 supports a 2.5" SATA HDD with up to 3 Gb/s data transfer rate. Three serial ports, two external USB 2.0 ports and two external USB 3.0 ports ensure simplified connectivity to a variety of external peripheral devices.

## 1.2 Model Variations

The model variations of the ECN-780-Q67 series are listed below.

Models	Display	Power	Serial Ports	Wireless
<b>ECN-780-Q67-R10</b>	VGA + DVI + HDMI	100 ~ 240V AC input	Three	N/A
<b>ECN-780W-Q67-R10</b>	VGA + DVI + HDMI	100 ~ 240V AC input	Three	802.11b/g/n

**Table 1-1: Model Variations**

## 1.3 Features

The ECN-780-Q67 features are listed below:

- 2nd Generation Intel® Core™ i7/i5/i3, Celeron® and Pentium® desktop processor supported

## ECN-780-Q67 Embedded System

- Intel® HD graphics supports H.264/AVC-MPEG2/VC1, DirectX 10.1 and OpenGL 3.0
- On-board 2GB DDR3 memory and one DDR3 SO-DIMM slot (system max. 10 GB)
- Dual Gigabit Ethernet with Intel® AMT 7.0 support
- Dual display output supported by VGA/DVI/HDMI
- Optional 2.4GHz 802.11 b/g/n Wi-Fi
- Easy to install SATA hard drive
- USB 3.0 ports provide super speed data transfer

### 1.4 Technical Specifications

The ECN-780-Q67 technical specifications are listed in **Table 1-2**.

Chassis	
Color	Black
Dimensions	230 x 60 x 173 mm
Chassis Construction	SECC
Motherboard	
CPU	2nd Generation Intel® Core™ i7/i5/i3, Celeron® and Pentium® desktop processor
Chipset	Intel® Q67
Ethernet	Intel® 82579 PHY with Intel® AMT 7.0 supported Intel® 82583V Ethernet controller
Audio	Realtek ALC892 HD Audio
Memory	On-board 2GB DDR3 memory 1 x 204-pin 1066/1333 MHz dual-channel DDR3 SDRAM SO-DIMM slot (system max. 10GB)
Storage	
SATA	1 x 2.5" SATA HDD Space



System Function	
USB	2 x USB 3.0 on rear side 2 x USB 2.0 on front side
Ethernet	2 x RJ-45 Gigabit LAN
RS-232	1 x RS-232 on rear side 1 x RS-232 on front side
RS-422/485	1 x RS-422/485 on front side
Display	1 x HDMI 1 x DVI-D 1 x VGA
Resolution	Up to 2048 x 1536 @ 75Hz (VGA), 1920 x 1200 @ 60Hz (HDMI), 1920 x 1080 @ 60Hz (DVI-D)
Audio	1 x Mic-in, 1 x Line-out on rear
Interior Expansions	2 x PCIe Mini slot (reserved for Wi-Fi and TV-Tuner)
Switch	Reset switch AT/ATX switch
Watchdog Timer	Software programmable support 1~255 sec. system reset
Power	
Power Supply	100 ~ 240V AC input
Power Consumption	19V@3.5A (Intel® Core™ i7-2600S CPU with 1333MHz 4G DDR3 memory)
Reliability	
Mounting	Desktop, Wall mount
Operating Temperature	-20°C ~ 50°C with air flow
Storage Temperature	-30°C ~ 60°C with air flow
Operating Humidity	5% ~95%, non-condensing
Operating Shock	Half-sine wave shock 3G, 11ms, 3 shocks per axis
Operating Vibration	Meet MIL-STD-810F 514.5C-2 (with SSD)

## ECN-780-Q67 Embedded System

Weight (Net/Gross)	3.1 Kg/4.3 Kg
Safety & EMC	CE/FCC

**Table 1-2: Technical Specifications**

### 1.5 Front Panel

The front panel of the ECN-780-Q67 has the following features (**Figure 1-2**):

- 1 x HDD LED
- 1 x Power button
- 1 x Power LED
- 1 x RS-232 DB-9 connector (COM3)
- 1 x RS-422/485 DB-9 connector (COM5)
- 2 x USB 2.0 connectors



**Figure 1-2: ECN-780-Q67 Front Panel**

### 1.6 Rear Panel

The rear panel of the ECN-780-Q67 has the following features (**Figure 1-3**):

- 1 x AC jack
- 1 x AT/ATX switch
- 2 x Audio jacks (Mic, Line-out)

- 1 x RS-232 DB-9 connector (COM1)
- 1 x DVI-D port
- 1 x HDMI port
- 1 x Reset button
- 2 x RJ-45 LAN connectors
- 1 x TV Tuner antenna reserved
- 2 x USB 3.0 connectors
- 1 x VGA port
- 1 x Wi-Fi antenna reserved

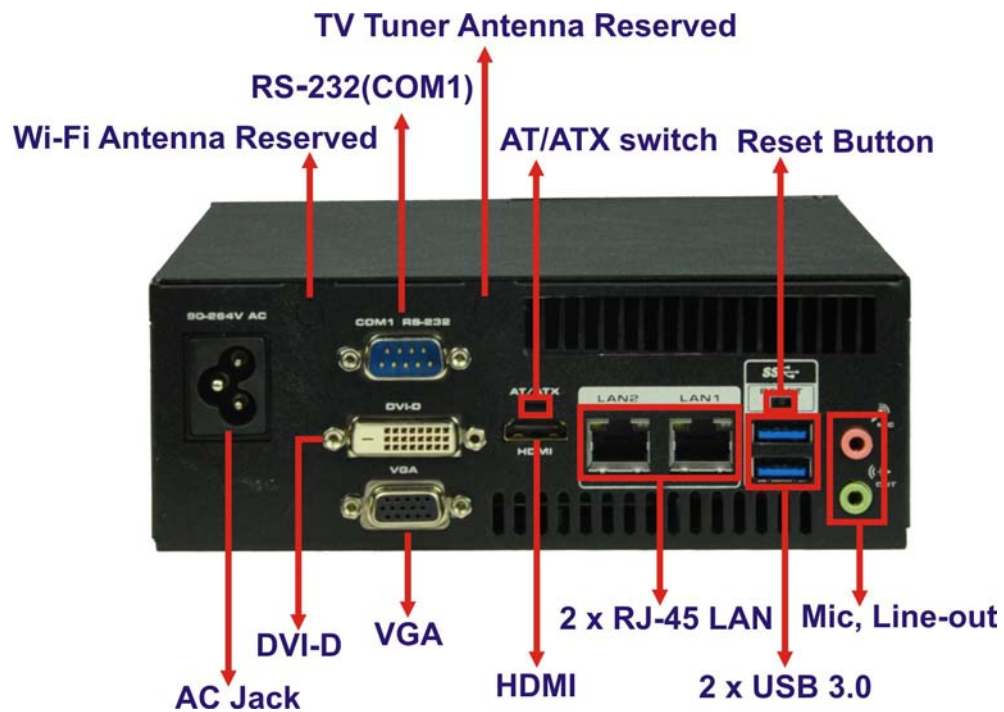


Figure 1-3: ECN-780-Q67 Rear Panel

## 1.7 Dimensions

The physical dimensions are shown below:

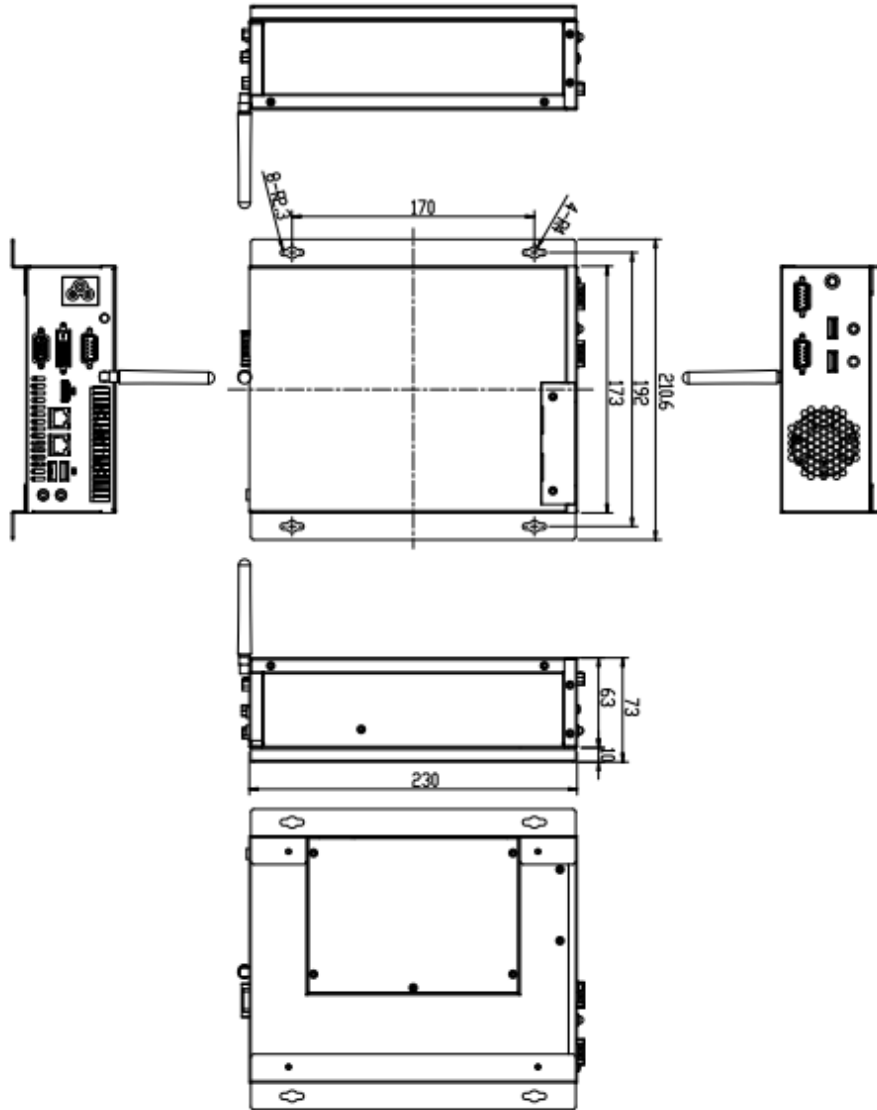


Figure 1-4: Physical Dimensions (mm)



Chapter

2

# Unpacking

---

## 2.1 Anti-static Precautions

---



### WARNING:

Failure to take ESD precautions during installation may result in permanent damage to the ECN-780-Q67 and severe injury to the user.

---

Electrostatic discharge (ESD) can cause serious damage to electronic components, including the ECN-780-Q67. Dry climates are especially susceptible to ESD. It is therefore critical that whenever the ECN-780-Q67 or any other electrical component is handled, the following anti-static precautions are strictly adhered to.

- **Wear an anti-static wristband:** Wearing a simple anti-static wristband can help to prevent ESD from damaging the board.
- **Self-grounding:** Before handling the board, touch any grounded conducting material. During the time the board is handled, frequently touch any conducting materials that are connected to the ground.
- **Use an anti-static pad:** When configuring the ECN-780-Q67, place it on an anti-static pad. This reduces the possibility of ESD damaging the ECN-780-Q67.

## 2.2 Unpacking Precautions

When the ECN-780-Q67 is unpacked, please do the following:

- Follow the anti-static precautions outlined in **Section 2.1**.
- Make sure the packing box is facing upwards so the ECN-780-Q67 does not fall out of the box.
- Make sure all the components shown in **Section 2.3** are present.






## 2.3 Unpacking Checklist



### NOTE:

If some of the components listed in the checklist below are missing, please do not proceed with the installation. Contact the IEI reseller or vendor you purchased the ECN-780-Q67 from or contact an IEI sales representative directly. To contact an IEI sales representative, please send an email to [sales@iei.com.tw](mailto:sales@iei.com.tw).

The ECN-780-Q67 is shipped with the following components:

Quantity	Item and Part Number	Image
1	ECN-780-Q67 multimedia box	
1	Power cord ( <b>P/N:</b> 32702-000401-100-RS)	
1	Power cord convert cable ( <b>P/N:</b> 32000-089400-RS)	
2	Mounting brackets	
4	Mounting bracket screws ( <b>P/N:</b> 44015-030041-RS)	
1	Wi-Fi antenna (for Wi-Fi module only) ( <b>P/N:</b> 32505-000900-100-RS)	

Quantity	Item and Part Number	Image
1	Thermal pad ( <b>P/N:</b> 34100-000197-RS)	
1	Utility CD	
1	One Key Recovery CD	

**Table 2-1: Package List Contents**





Chapter

3

# Installation

---

### 3.1 Installation Precautions

During installation, be aware of the precautions below:

- **Read the user manual:** The user manual provides a complete description of the ECN-780-Q67, installation instructions and configuration options.
- **DANGER! Disconnect Power:** Power to the ECN-780-Q67 must be disconnected during the installation process, or before any attempt is made to access the rear panel. Electric shock and personal injury might occur if the rear panel of the ECN-780-Q67 is opened while the power cord is still connected to an electrical outlet.
- **Qualified Personnel:** The ECN-780-Q67 must be installed and operated only by trained and qualified personnel. Maintenance, upgrades, or repairs may only be carried out by qualified personnel who are familiar with the associated dangers.
- **Grounding:** The ECN-780-Q67 should be properly grounded. The voltage feeds must not be overloaded. Adjust the cabling and provide external overcharge protection per the electrical values indicated on the label attached to the back of the ECN-780-Q67.

### 3.2 Installation and Configuration Steps

The following installation steps must be followed.

- Step 1: Unpack the ECN-780-Q67.
- Step 2: Install the HDD.
- Step 3: Configure the system.
- Step 4: Connect peripheral devices to the ECN-780-Q67.
- Step 5: Mount the ECN-780-Q67.

### 3.3 Hard Disk Drive (HDD) Installation

To install the hard drive, please follow the steps below:

- Step 1: Remove five (5) retention screws from the HDD cover (**Figure 3-1**).



**Figure 3-1: Retention Screws Removal**

**Step 2:** Open the HDD cover and locate the HDD bracket (**Figure 3-2**).



**Figure 3-2: HDD Bracket**

## ECN-780-Q67 Embedded System

**Step 3:** Attach the HDD to the HDD bracket, and then slide the HDD to connect the HDD to the SATA connector. Secure the HDD with the HDD bracket by four retention screws (**Figure 3-3**).



**Figure 3-3: HDD Retention Screws**

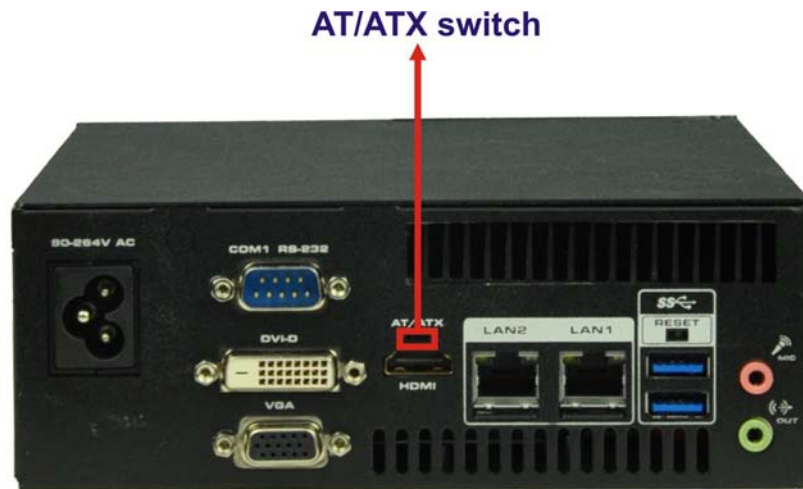
**Step 4:** Replace the HDD cover and secure it using five (5) previously removed retention screws.

### 3.4 AT/ATX Mode Selection

AT or ATX power mode can be used on the ECN-780-Q67. The selection is made through an AT/ATX switch located on the rear panel (**Figure 3-4**). To select AT mode or ATX mode, follow the steps below.

**Step 1:** Locate the AT/ATX switch on the rear panel (**Figure 3-4**).





**Figure 3-4: AT/ATX Switch Location**

**Step 2:** Adjust the AT/ATX switch.

### 3.4.1 AT Power Mode

With the AT mode selected, the power is controlled by a central power unit rather than a power switch. The ECN-780-Q67 panel PC turns on automatically when the power is connected. The AT mode benefits a production line to control multiple panel PCs from a central management center and other applications including:

- ATM
- Self-service kiosk
- Plant environment monitoring system
- Factory automation platform
- Manufacturing shop flow

### 3.4.2 ATX Power Mode

With the ATX mode selected, the ECN-780-Q67 panel PC goes in a standby mode when it is turned off. The panel PC can be easily turned on via network or a power switch in standby mode. Remote power control is perfect for advertising applications since the broadcasting time for each panel PC can be set individually and controlled remotely. Other possible application includes:

- Security surveillance

## ECN-780-Q67 Embedded System

- Point-of-Sale (POS)
- Advertising terminal

### 3.5 Reset the System

The reset button enables user to reboot the system when the system is turned on. To reboot the system, follow the steps below.

**Step 1:** Locate the reset button on the rear panel (**Figure 3-5**).



**Figure 3-5: Reset Button Location**

**Step 2:** Press the reset button.

### 3.6 Powering On/Off the System

To power on the system, follow the steps below:

**Step 1:** Press the power button on the front panel for 3 seconds (**Figure 3-6**).

**Step 2:** Once turned on, the power LED should light up.

To power off the system, follow the steps below:

**Step 3:** Press the power button on the front panel for 6 seconds (**Figure 3-6**).

**Step 4:** Once turned off, the power LED will be off.



Figure 3-6: Power Button Location

### 3.7 Mount the System

The ECN-780-Q67 supports wall mounting. The bottom panel of the ECN-780-Q67 contains four screw holes for mounting (**Figure 3-7**) the system.



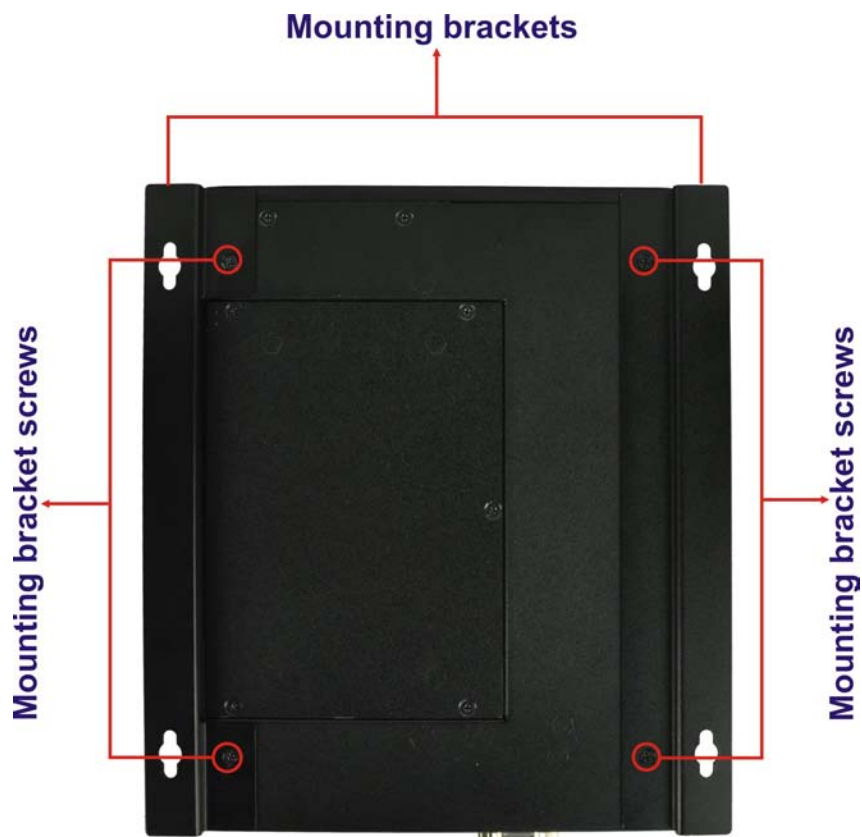
Figure 3-7: Mounting Screw Holes



### 3.7.1 Mounting the System with Mounting Brackets

To mount the embedded system onto a wall or some other surface using the two mounting brackets, please follow the steps below.

- Step 1:** Turn the embedded system over.
- Step 2:** Align the two retention screw holes in each bracket with the corresponding retention screw holes on the sides of the bottom surface.
- Step 3:** Secure the brackets to the system by inserting two retention screws into each bracket as illustrated in **Figure 3-8**.



**Figure 3-8: Mounting Bracket Retention Screws**

- Step 4:** Drill holes in the intended installation surface.
- Step 5:** Align the mounting holes in the sides of the mounting brackets with the predrilled holes in the mounting surface.



**NOTE:**

To have the best system heat dissipation, please make sure to face the I/O panel downward (**Figure 3-8**) when mounting the system.

**Step 6:** Insert four retention screws, two in each bracket, to secure the system to the wall.

### 3.8 External Peripheral Interface Connectors

The following external peripheral devices can be connected to the external peripheral interface connectors.

- Audio devices
- DVI devices
- HDMI devices
- RJ-45 Ethernet cable connector
- Serial devices
- USB devices
- VGA monitor

To install these devices, connect the corresponding cable connector from the actual device to the corresponding ECN-780-Q67 external peripheral interface connector making sure the pins are properly aligned.

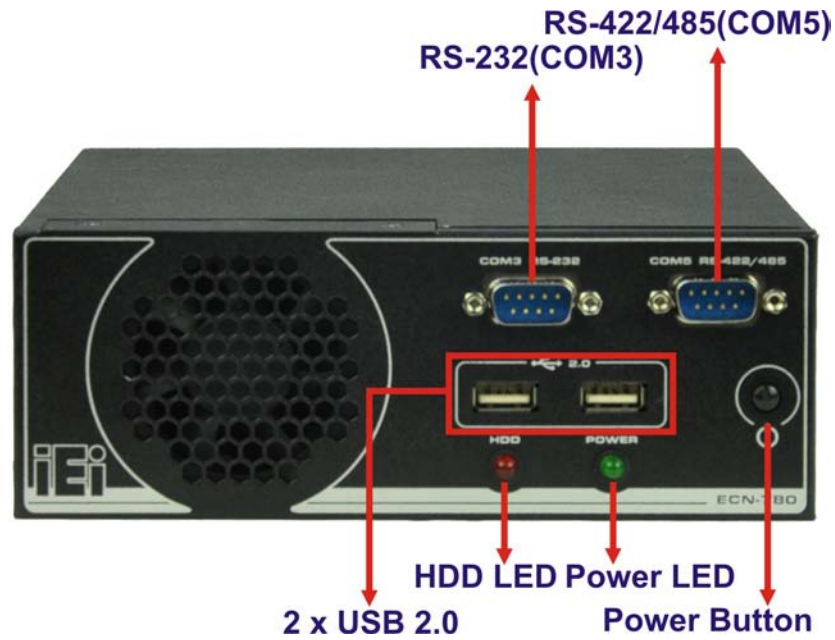


Figure 3-9: Peripheral Connectors (Front Panel)

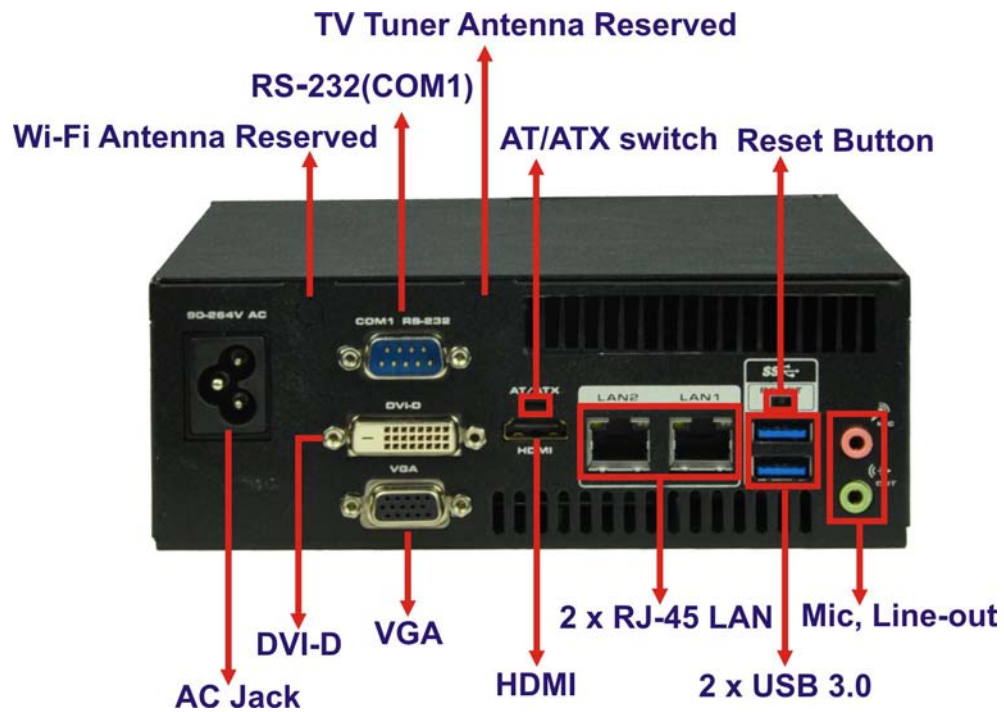


Figure 3-10: Peripheral Connectors (Rear Panel)

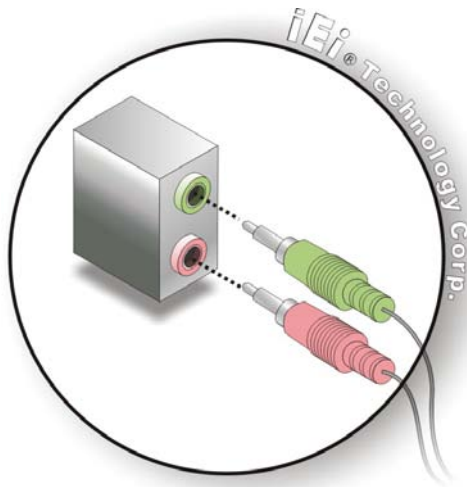
### 3.8.1 Audio Connection

The audio jacks on the external audio connector enable the ECN-780-Q67 to be connected to a stereo sound setup. To install the audio devices, follow the steps below.

**Step 1: Identify the audio plugs.** The plugs on your home theater system or speakers may not match the colors on the rear panel. If audio plugs are plugged into the wrong jacks, sound quality will be very bad.

**Step 2: Plug the audio plugs into the audio jacks.** Plug the audio plugs into the audio jacks. If the plugs on your speakers are different, an adapter will need to be used to plug them into the audio jacks.

- **Line Out port (Lime):** Connects to a headphone or a speaker.
- **Microphone (Pink):** Connects to a microphone.



**Figure 3-11: Audio Connector**

**Step 3: Check audio clarity.** Check that the sound is coming through the right speakers by adjusting the balance front to rear and left to right.

### 3.8.2 DVI Display Device Connection

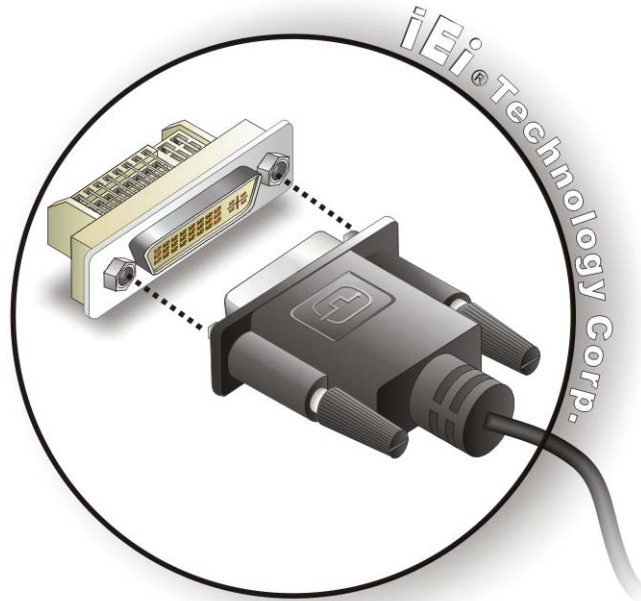
The ECN-780-Q67 has one female DVI connector on the rear panel. The DVI connectors are connected to digital display devices. To connect a digital display device to the ECN-780-Q67, please follow the instructions below.

**Step 1: Locate the DVI connector.** The location of the DVI connector is shown in **Chapter 1**.



## ECN-780-Q67 Embedded System

- Step 2: Align the DVI connector.** Align the male DVI connector on the digital display device cable with the female DVI connector on the external peripheral interface.
- Step 3: Insert the DVI connector.** Once the connectors are properly aligned with the male connector, insert the male connector from the digital display device into the female connector on the ECN-780-Q67. See Figure 3-12.



**Figure 3-12: DVI Connector**

- Step 4: Secure the connector.** Secure the DVI connector from the digital display device to the external interface by tightening the two retention screws on either side of the connector.

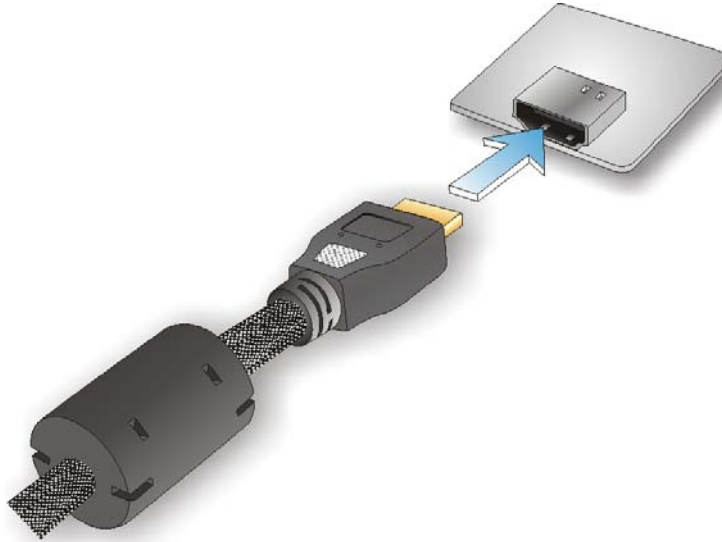
### 3.8.3 HDMI Device Connection

The HDMI connector transmits a digital signal to compatible HDMI display devices such as a TV or computer screen. To connect the HDMI cable to the ECN-780-Q67, follow the steps below.

- Step 1: Locate the HDMI connector.** The location is shown in **Chapter 1**.



**Step 2: Align the connector.** Align the HDMI connector with the HDMI port. Make sure the orientation of the connector is correct.



**Figure 3-13: HDMI Connection**

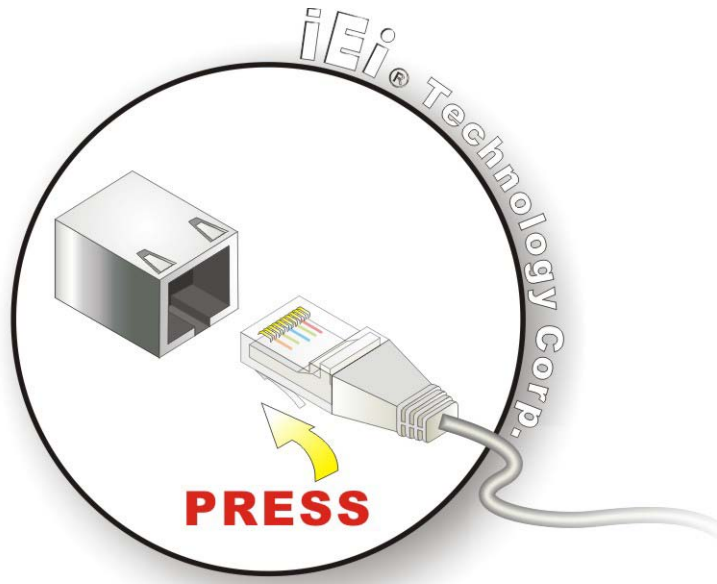
**Step 3: Insert the HDMI connector.** Gently insert the HDMI connector. The connector should engage with a gentle push. If the connector does not insert easily, check again that the connector is aligned correctly, and that the connector is being inserted with the right way up.

### 3.8.4 LAN Connection

There are two external RJ-45 LAN connectors. The RJ-45 connector enables connection to an external network. To connect a LAN cable with an RJ-45 connector, please follow the instructions below.

**Step 1: Locate the RJ-45 connectors.** The location of the LAN connector is shown in **Chapter 1**.

**Step 2: Align the connectors.** Align the RJ-45 connector on the LAN cable with one of the RJ-45 connectors on the ECN-780-Q67. See Figure 3-14.



**Figure 3-14: LAN Connection**

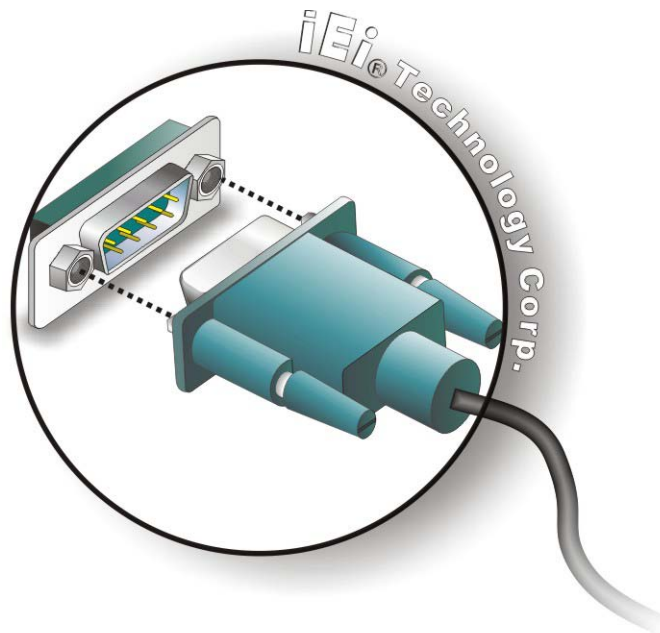
**Step 3:** Insert the LAN cable RJ-45 connector. Once aligned, gently insert the LAN cable RJ-45 connector into the RJ-45 connector.

### 3.8.5 DB-9 Serial Port Connection

There are two RS-232 DB-9 connectors and one RS-422/485 connector of the ECN-780-Q67 for serial device connection. Follow the steps below to connect a serial device to the DB-9 connector of the ECN-780-Q67.

**Step 1:** Locate the DB-9 connector. The locations of the DB-9 connectors are shown in **Chapter 1**.

**Step 2:** Insert the serial connector. Insert the DB-9 connector of a serial device into the DB-9 connector on the rear panel. See Figure 3-15.



**Figure 3-15: DB-9 Serial Port Connector**

**Step 3: Secure the connector.** Secure the serial device connector to the external interface by tightening the two retention screws on either side of the connector.

### 3.8.6 USB Device Connection



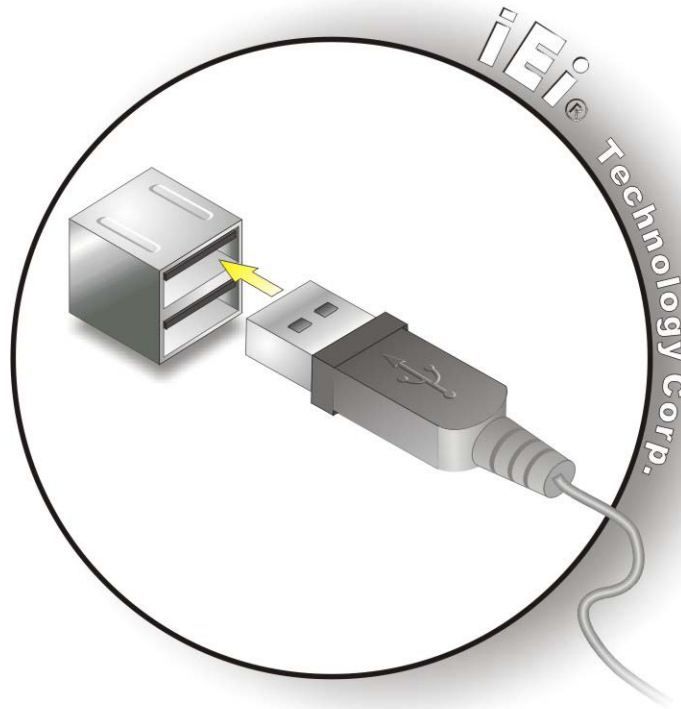
**NOTE:**

User must install the USB 3.0 driver before connecting a USB device to the system or else the system may not recognize the connected device.

There are two USB 2.0 connectors and two USB 3.0 connectors on the ECN-780-Q67. To connect a USB device, please follow the instructions below.

**Step 1: Locate the USB connectors.** The locations of the USB connectors are shown in **Chapter 1**.

**Step 2:** **Align the connectors.** Align the USB device connector with one of the connectors on the external peripheral interface. See **Figure 3-16**.



**Figure 3-16: USB Device Connection**

**Step 3:** **Insert the device connector.** Once aligned, gently insert the USB device connector into the onboard connector.

### 3.8.7 VGA Monitor Connection

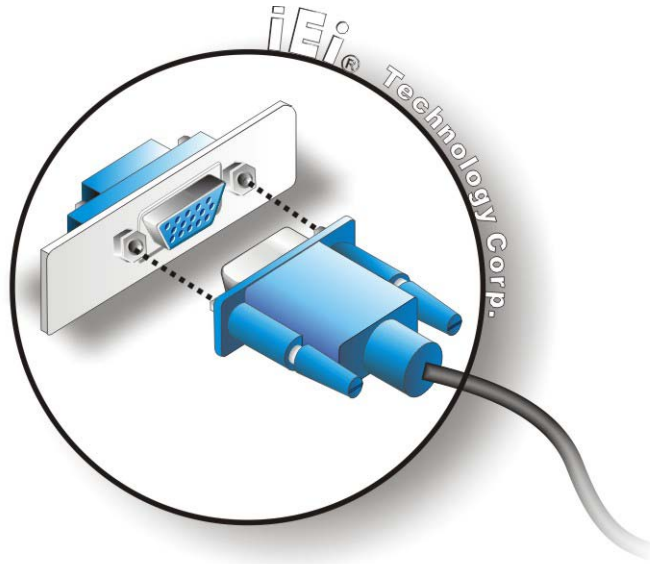
The ECN-780-Q67 has a single female DB-15 connector on the external peripheral interface panel. The DB-15 connector is connected to a CRT or VGA monitor. To connect a monitor to the ECN-780-Q67, please follow the instructions below.

**Step 1:** **Locate the female DB-15 connector.** The location of the female DB-15 connector is shown in **Chapter 3**.

**Step 2:** **Align the VGA connector.** Align the male DB-15 connector on the VGA screen cable with the female DB-15 connector on the external peripheral interface.



**Step 3:** **Insert the VGA connector.** Once the connectors are properly aligned with the insert the male connector from the VGA screen into the female connector on the ECN-780-Q67. See **Figure 3-17**.



**Figure 3-17: VGA Connector**

**Step 4:** **Secure the connector.** Secure the DB-15 VGA connector from the VGA monitor to the external interface by tightening the two retention screws on either side of the connector.

### 3.9 Intel® AMT Setup Procedure

The ECN-780-Q67 is featured with the Intel® Active Management Technology (AMT). To enable the Intel® AMT function, follow the steps below.

**Step 1:** Make sure the memory socket is installed with one DDR3 DIMM.

**Step 2:** Connect an Ethernet cable to one of the RJ-45 connector LANs which supports AMT.

**Step 3:** The AMI BIOS options regarding the Intel® ME or Intel® AMT must be enabled,

- Step 4:** Properly install the Intel® Management Engine Components drivers from the iAMT Driver & Utility directory in the driver CD.
- Step 5:** Configure the Intel® Management Engine BIOS extension (MEBx). To get into the Intel® MEBx settings, press <Ctrl+P> after a single beep during boot-up process. Enter the Intel® current ME password as it requires (the Intel® default password is **admin**).



### **NOTE:**

To change the password, enter a new password following the strong password rule (containing at least one upper case letter, one lower case letter, one digit and one special character, and be at least eight characters).

---



Chapter

4

# System Motherboard

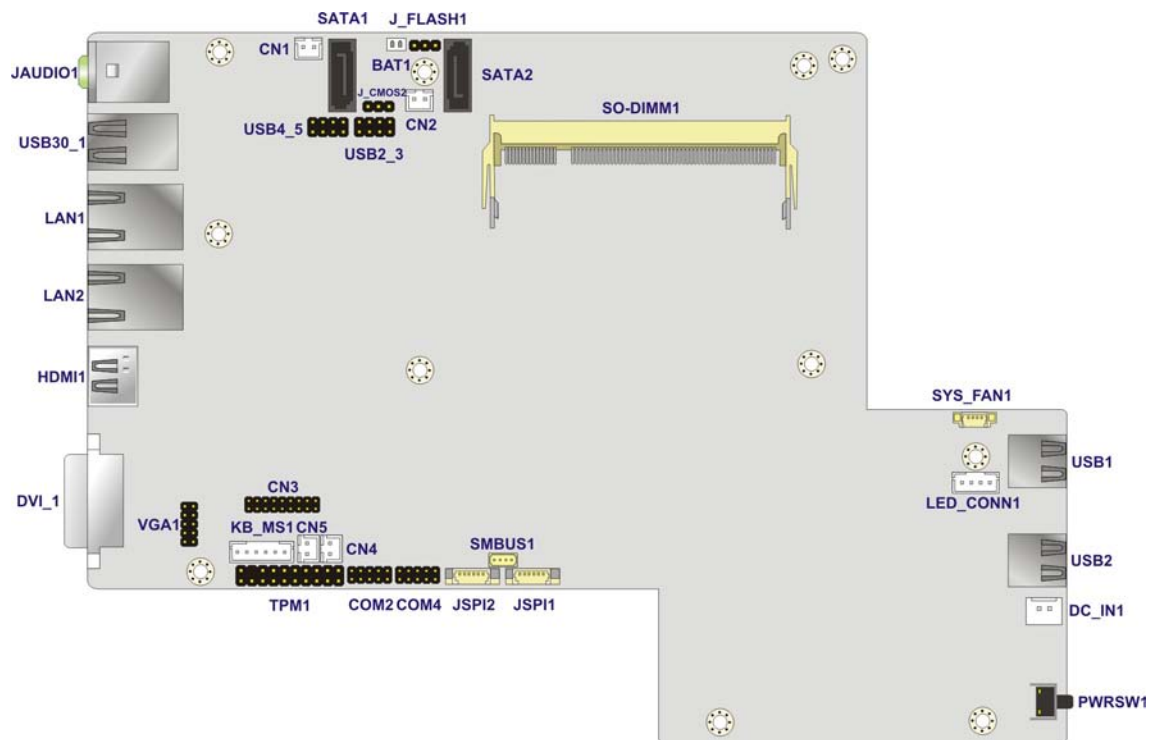
---

## 4.1 Overview

The ECN-780-Q671 embedded system motherboard comes with a number of peripheral interface connectors and configuration jumpers.

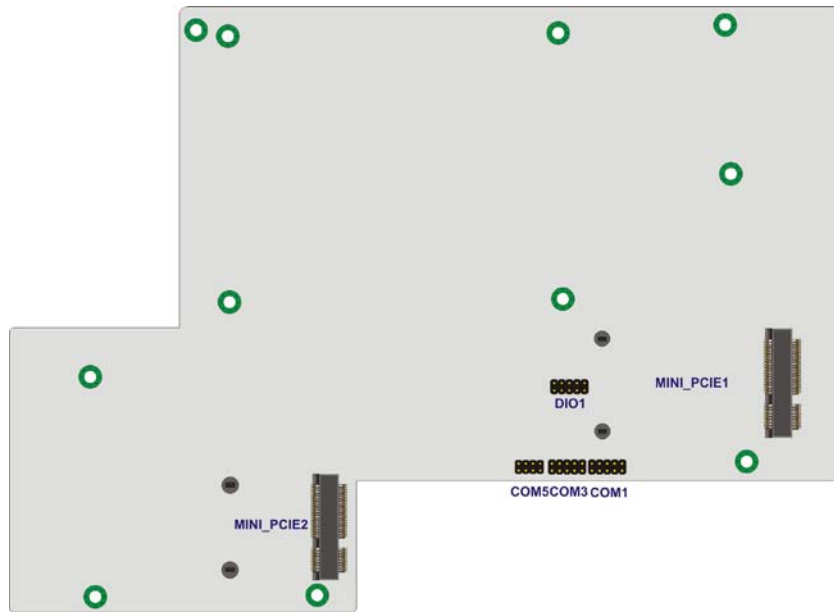
### 4.1.1 Layout

The connector locations are shown in **Figure 4-1**. The connector pinouts for these connectors are listed in the following sections.



**Figure 4-1: Connector and Jumper Locations (Front Side)**

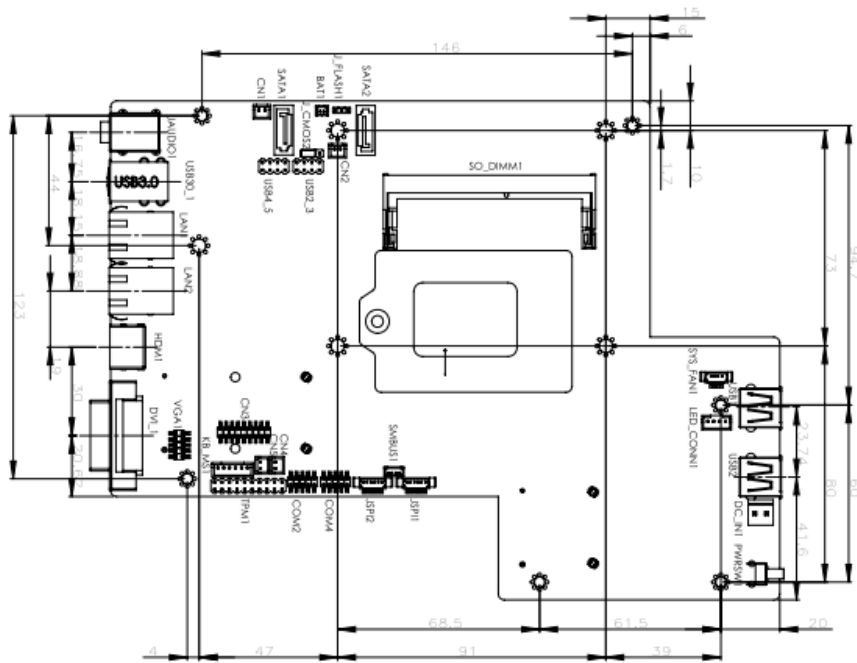




**Figure 4-2: Connector and Jumper Locations (Rear Side)**

#### 4.1.2 Motherboard Dimensions

The main dimensions of the system motherboard are shown in the diagram below.



**Figure 4-3: Motherboard Dimensions (Front Side) (mm)**



Connector	Type	Label
Power connector	2-pin wafer	DC_IN1
RS-232 serial ports	10-pin header	COM1, COM2, COM3, COM4
RS-422/485 serial port	8-pin header	COM5
SATA connectors	SATA connector	SATA1, SATA2
SATA power connectors	2-pin wafer	CN1, CN2
SMBus connector	4-pin wafer	SMBUS1
SO-DIMM connector	SO-DIMM slot	SO-DIMM1
K Type thermocouple connectors	2-pin wafer	CN4, CN5
TPM connector	20-pin header	TPM1
USB 2.0 connectors	8-pin header	USB2_3, USB4_5
VGA connector	10-pin header	VGA1

**Table 4-1: Peripheral Interface Connectors**

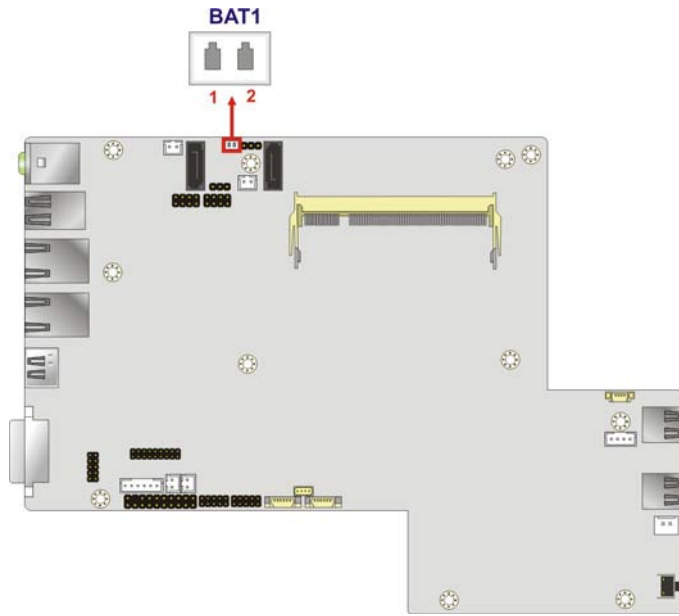
## 4.2 Internal Peripheral Connectors

Internal peripheral connectors are found on the motherboard and are only accessible when the motherboard is outside of the chassis. This section has complete descriptions of all the internal, peripheral connectors on the ECN-780-Q67.

### 4.2.1 Battery Connector

CN Label:	BAT1
CN Type:	2-pin wafer
CN Location:	See <b>Figure 4-5</b>
CN Pinouts:	See <b>Table 4-2</b>

This is connected to the system battery. The battery provides power to the system clock to retain the time when power is turned off.



**Figure 4-5: Battery Connector Location**

Pin	Description
1	VBATT
2	GND

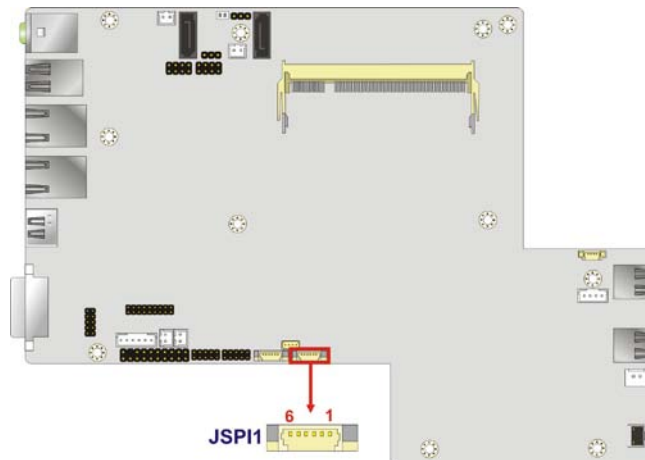
**Table 4-2: Battery Connector Pinouts**

#### 4.2.2 BIOS Programming Connector

- CN Label: JSP11
- CN Type: 6-pin wafer
- CN Location: See **Figure 4-6**
- CN Pinouts: See **Table 4-3**

The connector is for BIOS programming.




**Figure 4-6: BIOS Programming Connector Location**

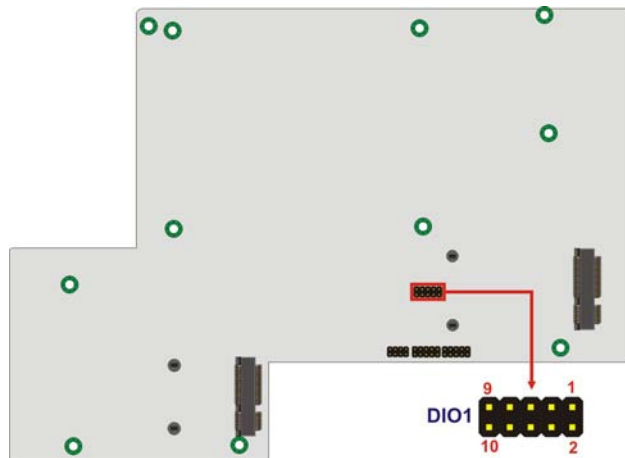
PIN NO.	DESCRIPTION	PIN NO.	DESCRIPTION
1	SPI_VCC	2	SPI_CS#0_CN
3	SPI_S00_CN	4	SPI_CLK0_CN
5	SPI_S10_CN	6	GND

**Table 4-3: BIOS Programming Connector Pinouts**

#### 4.2.3 Digital I/O Connector

CN Label:	DIO1
CN Type:	10-pin header
CN Location:	See <b>Figure 4-7</b>
CN Pinouts:	See <b>Table 4-4</b>

The digital I/O connector provides programmable input and output for external devices. The digital I/O provides 4-bit output and 4-bit input.



**Figure 4-7: Digital I/O Connector Location**

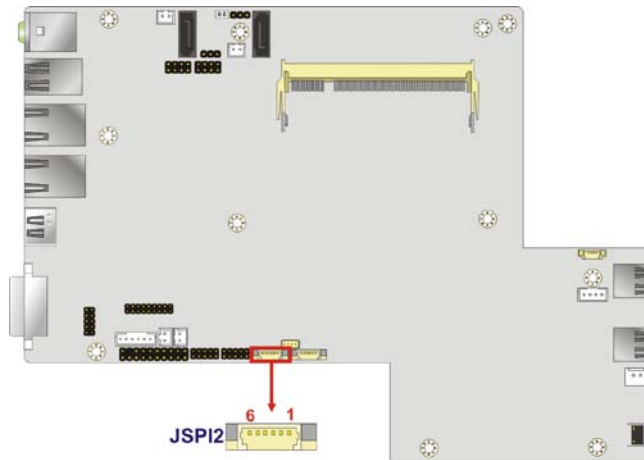
PIN NO.	DESCRIPTION	PIN NO.	DESCRIPTION
1	+V5S	2	+V5S
3	DOUT4	4	DOUT3
5	DOUT2	6	DOUT1
7	DIN4	8	DIN3
9	DIN2	10	DIN1

**Table 4-4: Digital I/O Connector Pinouts**

#### 4.2.4 EC Programming Connector

- CN Label: J SPI2
- CN Type: 6-pin wafer
- CN Location: See **Figure 4-8**
- CN Pinouts: See **Table 4-5**

The EC programming connector is used for programming the firmware.



**Figure 4-8: EC Programming Connector Location**

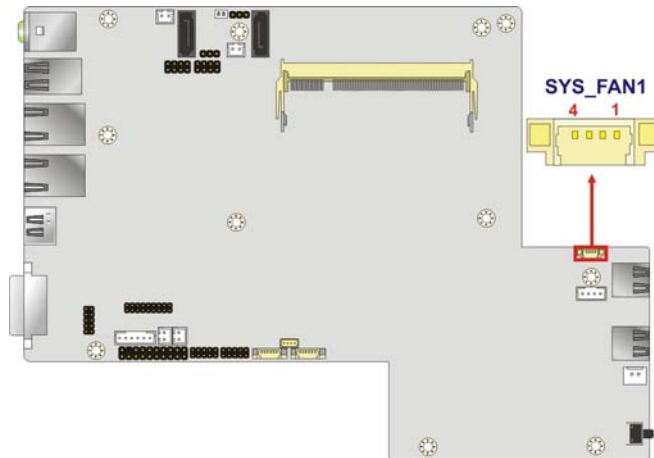
PIN NO.	DESCRIPTION	PIN NO.	DESCRIPTION
1	+V3.3A_EC_CONN	2	FSCE#_S
3	FMISO_S	4	FSCK_S
5	FMOSI_S	6	GND

**Table 4-5: EC Programming Connector Pinouts**

#### 4.2.5 Fan Connector (System)

- CN Label: SYS\_FAN1
- CN Type: 4-pin wafer
- CN Location: See **Figure 4-9**
- CN Pinouts: See **Table 4-6**

The fan connector attaches to a cooling fan.



**Figure 4-9: System Fan Connector Location**

Pin	Description
1	GND
2	+V12S
3	FANPWM1
4	FANIN1

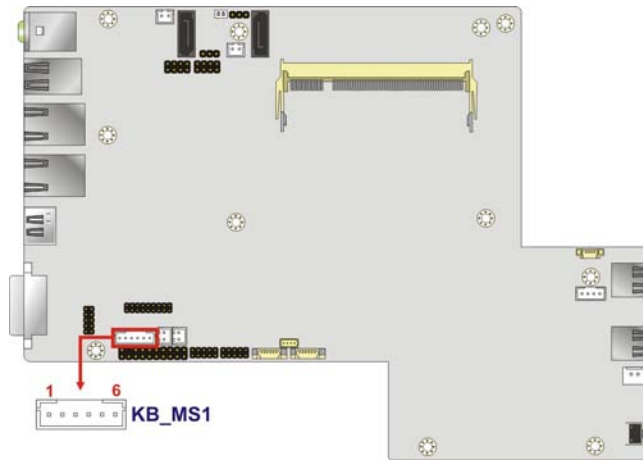
**Table 4-6: System Fan Connector Pinouts**

#### 4.2.6 Keyboard/Mouse Connector

- CN Label: KB\_MS1
- CN Type: 6-pin wafer
- CN Location: See **Figure 4-10**
- CN Pinouts: See **Table 4-7**

The keyboard/mouse connector connects to a PS/2 Y-cable that can be connected to a PS/2 keyboard and mouse.





**Figure 4-10: Keyboard/Mouse Connector Location**

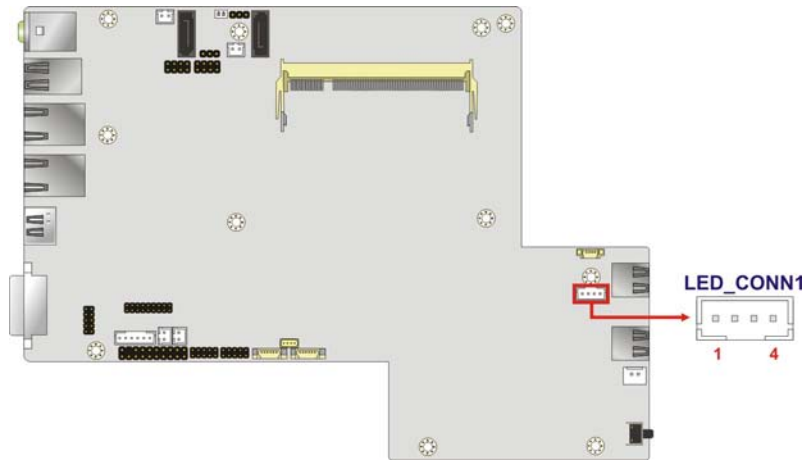
Pin	Description
1	VCC5_KBMS
2	MSDATA
3	MSCLK
4	KBDATA
5	KBCLK
6	GND

**Table 4-7: Keyboard/Mouse Connector Pinouts**

#### 4.2.7 LED Module Connector

- CN Label: LED\_CONN1
- CN Type: 4-pin wafer
- CN Location: See **Figure 4-11**
- CN Pinouts: See **Table 4-8**

The LED module connector connects to a LED module that shows indicators on the system front panel.



**Figure 4-11: LED Module Connector Location**

Pin	Description
1	+V5S
2	SATA_LED#
3	+V5A
4	GND

**Table 4-8: LED Module Connector Pinouts**

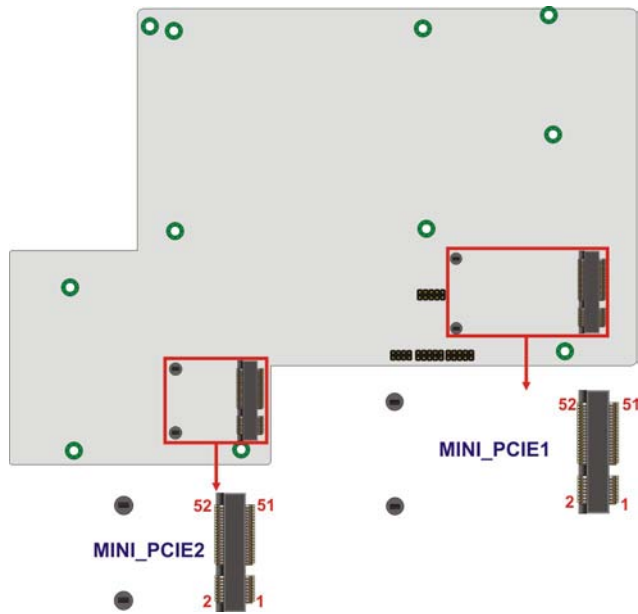
#### 4.2.8 PCIe Mini Card Slot

CN Label: MINI\_PCIE1, MINI\_PCIE2

CN Type: PCIe Mini card slot

CN Location: See **Figure 4-12**

The PCIe Mini card slot enables a PCIe Mini card expansion module to be connected to the board.

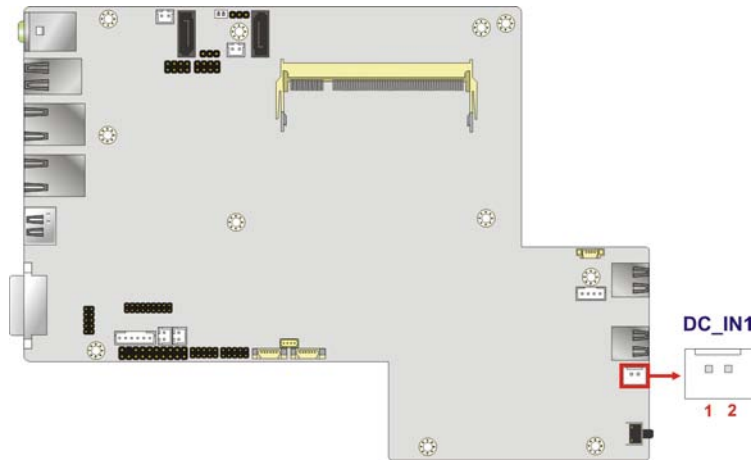


**Figure 4-12: PCIe Mini Card Slot Location**

#### 4.2.9 Power Connector

CN Label:	DC_IN1
CN Type:	2-pin wafer
CN Location:	See <b>Figure 4-13</b>
CN Pinouts:	See <b>Table 4-9</b>

The power connector provides power to the motherboard.



**Figure 4-13: Power Connector Location**

Pin	Description	Pin	Description
1	DC_IN	2	GND

**Table 4-9: Power Connector Pinouts**

#### 4.2.10 RS-232 Serial Port Connectors

CN Label: COM1, COM2, COM3, COM4

CN Type: 10-pin header

CN Location: See **Figure 4-14** and **Figure 4-15**

CN Pinouts: See **Table 4-10**

The 10-pin serial port connector provides one RS-232 serial communications channel. The COM serial port connector can be connected to an external RS-232 serial port device.



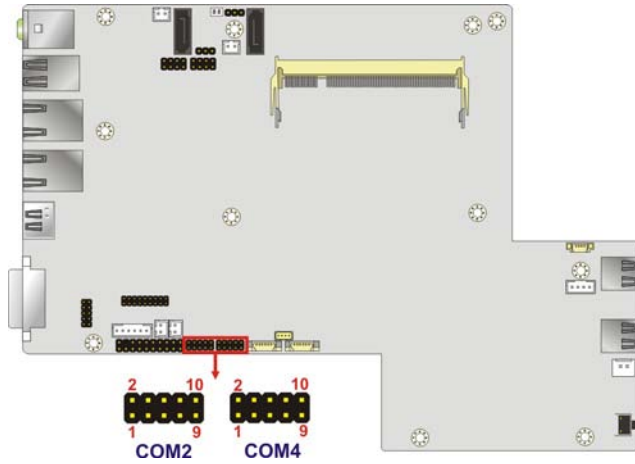


Figure 4-14: RS-232 Serial Port Connector Location

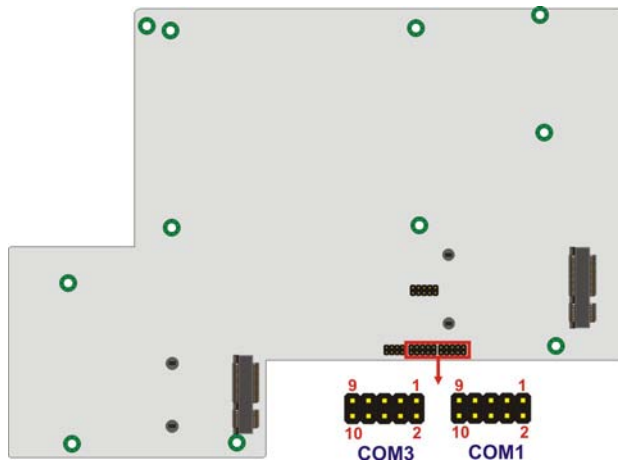


Figure 4-15: RS-232 Serial Port Connector Location

Pin	Description	Pin	Description
1	-NDCD1/2/3/4	6	-NDSR1/2/3/4
2	NSIN1/2/3/4	7	-NRTS1/2/3/4
3	NSOUT1/2/3/4	8	-NCTS1/2/3/4
4	-NDTR1/2/3/4	9	-XRI1/2/3/4
5	GND	10	N/A

Table 4-10: Serial Port Connector Pinouts (COM1, COM2, COM3, COM4 )

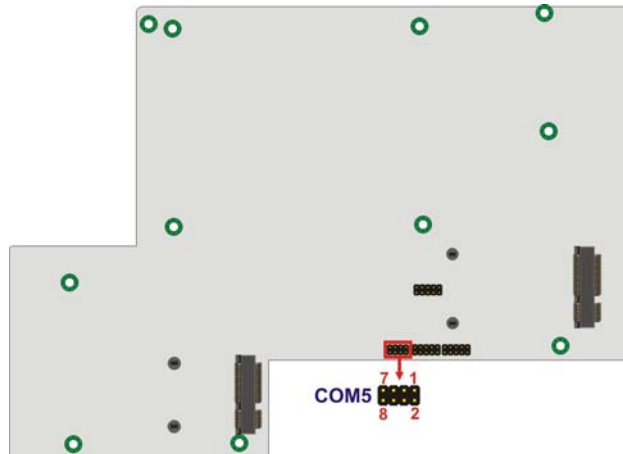
#### 4.2.11 RS-422/485 Serial Port Connector

CN Label: COM5

## ECN-780-Q67 Embedded System

CN Type: 8-pin header  
 CN Location: See **Figure 4-16**  
 CN Pinouts: See **Table 4-11**

This connector provides RS-422 or RS-485 communications.



**Figure 4-16: RS-422/485 Serial Port Connector Location**

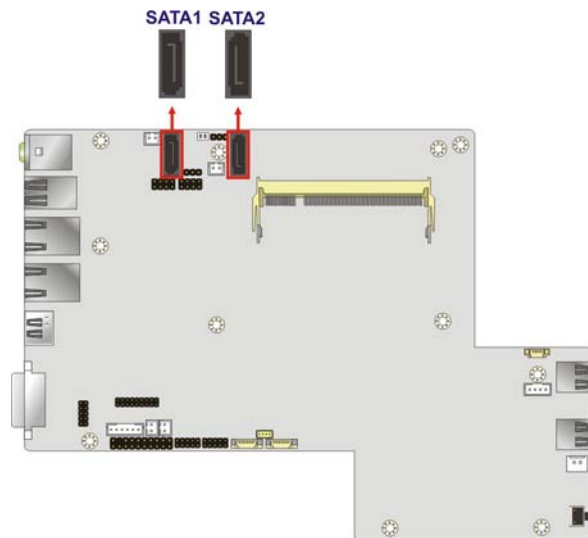
Pin	Description	Pin	Description
1	RXD485#	2	N/A
3	RXD485	4	N/A
5	TXD485	6	N/A
7	TXD485#	8	N/A

**Table 4-11: RS-422/485 Serial Port Connector Pinouts**

### 4.2.12 SATA Drive Connectors

CN Label: SATA1, SATA2  
 CN Type: 7-pin SATA drive connectors  
 CN Location: See **Figure 4-17**

The SATA connectors connect to SATA hard drives or optical drives with data transfer speeds as high as 3Gb/s.

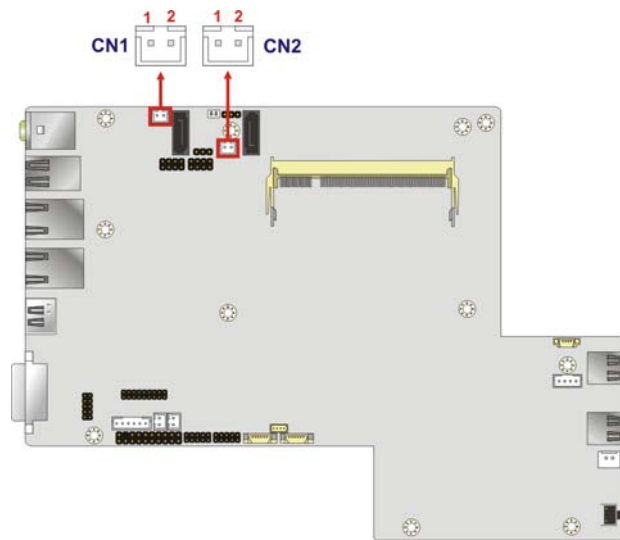


**Figure 4-17: SATA Drive Connector Locations**

#### 4.2.13 SATA Power Connectors

CN Label:	CN1, CN2
CN Type:	2-pin wafer
CN Location:	See <b>Figure 4-18</b>
CN Pinouts:	See <b>Table 4-12</b>

Use the SATA Power Connector to connect to SATA device power connections.



**Figure 4-18: SATA Power Connector Locations**

Pin	Description
1	+V5S
2	GND

**Table 4-12: SATA Power Connector Pinouts**

#### 4.2.14 SMBus Connector

- CN Label: SMBUS1
- CN Type: 4-pin wafer
- CN Location: See **Figure 4-19**
- CN Pinouts: See **Table 4-13**

The SMBus (System Management Bus) connector provides low-speed system management communications.



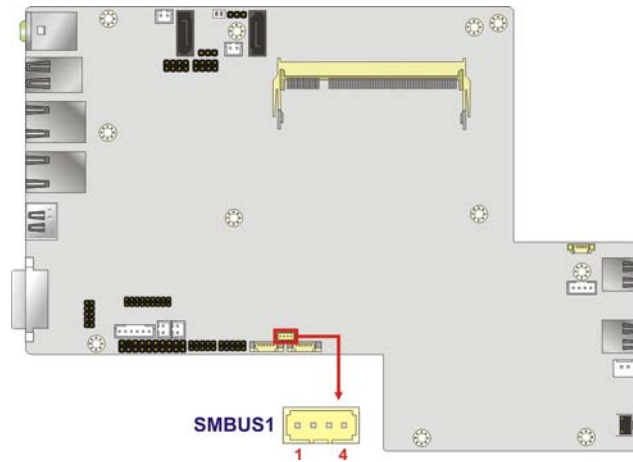


Figure 4-19: SMBus Connector Location

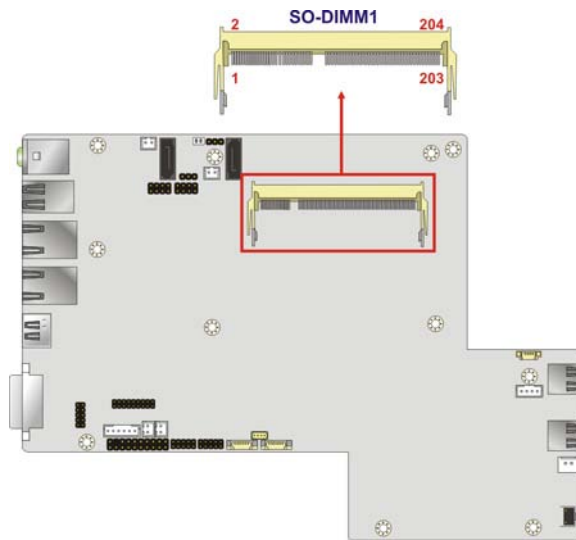
Pin	Description
1	GND
2	SMB_DATA
3	SMB_CLK_A
4	+V5S

Table 4-13: SMBus Connector Pinouts

#### 4.2.15 SO-DIMM Connector

- CN Label: SO-DIMM1
- CN Type: 204-pin DDR3 SO-DIMM slot
- CN Location: See **Figure 4-20**

The SO-DIMM slot is for installing memory on the system.

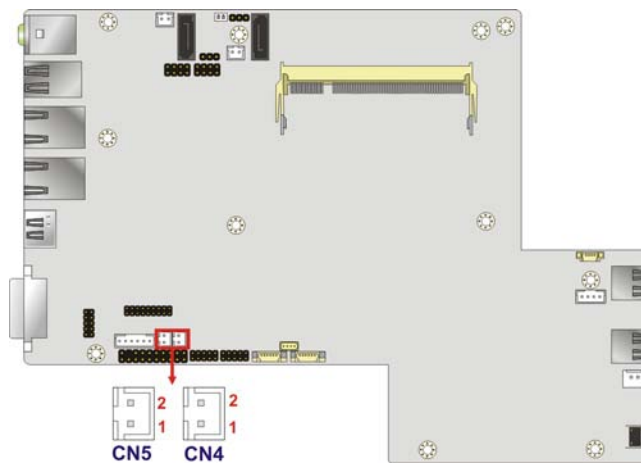


**Figure 4-20: SO-DIMM Connector Locations**

#### 4.2.16 K Type Thermocouple Connectors

CN Label:	CN4, CN5
CN Type:	2-pin wafer
CN Location:	See <b>Figure 4-21</b>
CN Pinouts:	See <b>Table 4-14</b>

The K type thermocouple connector connects to the K type thermocouple devices.



**Figure 4-21: Type K Thermocouple Connector Locations**

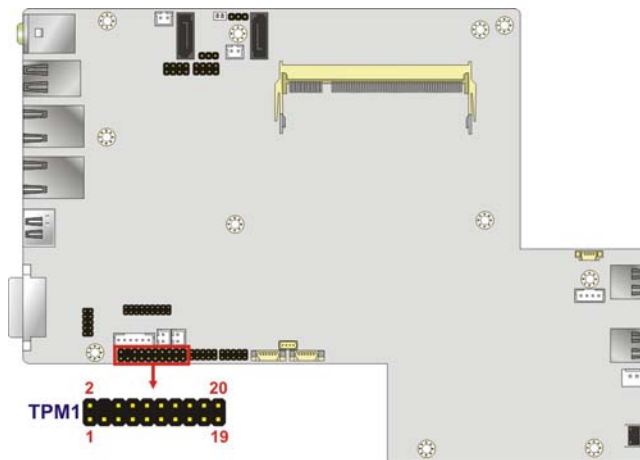
Pin	Description
1	D1-/D2-
2	D1+/D2+

**Table 4-14: Type K Thermocouple Connector Pinouts**

#### 4.2.17 TPM Connector

CN Label:            TPM1  
 CN Type:             20-pin header  
 CN Location:        See **Figure 4-22**  
 CN Pinouts:         See **Table 4-15**

The TPM connector connects to a TPM module.


**Figure 4-22: TPM Connector Location**

PIN NO.	DESCRIPTION	PIN NO.	DESCRIPTION
1	TPMPCLK	2	GND
3	LPC_FRAME#	4	N/A
5	PLT_RST#	6	+V5S
7	LPC_AD3	8	LPC_AD2
9	+V3.3S	10	LPC_AD1
11	LPC_AD0	12	GND
13	SMBCLK_MAIN	14	SMBDATA_MAIN

PIN NO.	DESCRIPTION	PIN NO.	DESCRIPTION
15	+V3.3A	16	INT_SERIRQ
17	GND	18	PM_CLKRUN#
19	LPCPD#	20	SIO_DRO#0

**Table 4-15: TPM Connector Pinouts**

#### 4.2.18 USB 2.0 Connectors

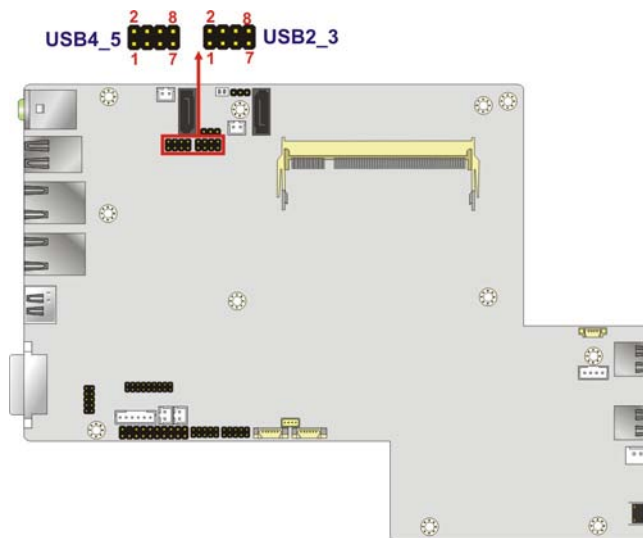
CN Label: USB2\_3, USB4\_5

CN Type: 8-pin header

CN Location: See **Figure 4-23**

CN Pinouts: See **Table 4-16**

The USB header can connect to two USB devices.



**Figure 4-23: USB Connector Locations**

Pin	Description	Pin	Description
1	VCC_USB23/45	2	GND
3	-DATA2/4	4	+DATA3/5
5	+DATA2/4	6	-DATA3/5



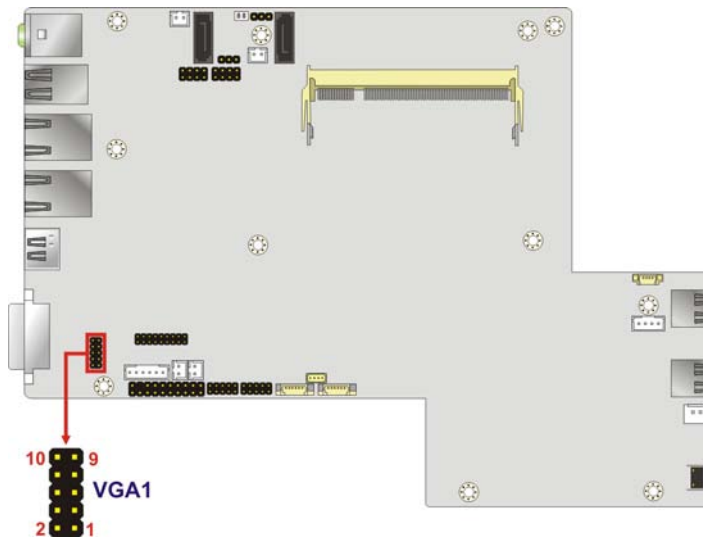
7	GND	8	VCC_USB23/45
---	-----	---	--------------

**Table 4-16: USB Port Connector Pinouts**

#### 4.2.19 VGA Connector

CN Label:	VGA1
CN Type:	10-pin header
CN Location:	See <b>Figure 4-24</b>
CN Pinouts:	See <b>Table 4-17</b>

The VGA connector connects to a monitor.


**Figure 4-24: VGA Connector Location**

Pin	Description	Pin	Description
1	CRT_RED	2	CRT_DDC_DATA
3	CRT_GREEN	4	CRT_DDC_CLK
5	CRT_BLUE	6	CRT_PLUG#
7	CRT_HSYNC	8	GND
9	CRT_VSYNC	10	GND

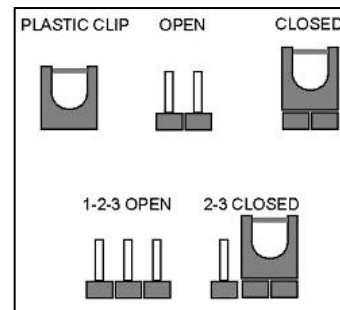
**Table 4-17: VGA Connector Pinouts**

### 4.3 Jumper Settings



**NOTE:**

A jumper is a metal bridge that is used to close an electrical circuit. It consists of two metal pins and a small metal clip (often protected by a plastic cover) that slides over the pins to connect them. To CLOSE/SHORT a jumper means connecting the pins of the jumper with the plastic clip and to OPEN a jumper means removing the plastic clip from a jumper.



The jumpers on the ECN-780-Q67 are listed in **Table 4-18**.

Description	Label	Type
Clear CMOS	J_CMOS2	3-pin header
Flash descriptor security override	J_FLASH1	3-pin header

**Table 4-18: Jumpers**

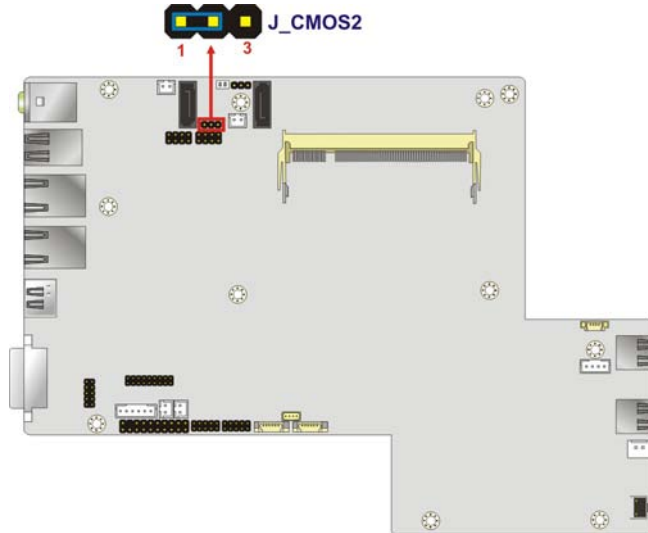
#### 4.3.1 Clear CMOS

- Jumper Label: J\_CMOS2
- Jumper Type: 3-pin header
- Jumper Settings: See **Table 4-19**
- Jumper Location: See **Figure 4-25**

If the ECN-780-Q67 fails to boot due to improper BIOS settings, the clear CMOS jumper clears the CMOS data and resets the system BIOS information. To do this, use the jumper cap to close pins 2 and 3 for a few seconds then reinstall the jumper clip back to pins 1 and 2. The clear CMOS jumper settings are shown in Table 4-19.

Pin	Description
Short 1-2	Keep CMOS Setup (Default)
Short 2-3	Clear CMOS Setup

**Table 4-19: Clear CMOS Jumper Settings**



**Figure 4-25: Clear CMOS Jumper Location**

### 4.3.2 Flash Descriptor Security Override

- Jumper Label: J\_FLASH1
- Jumper Type: 3-pin header
- Jumper Settings: See **Table 4-20**
- Jumper Location: See **Figure 4-26**

The Flash Descriptor Security Override jumper specifies whether to override the flash descriptor.

Setting	Description
Short 1-2	No overwrite (Default)
Short 2-3	Overwrite

**Table 4-20: Flash Descriptor Security Override Jumper Settings**

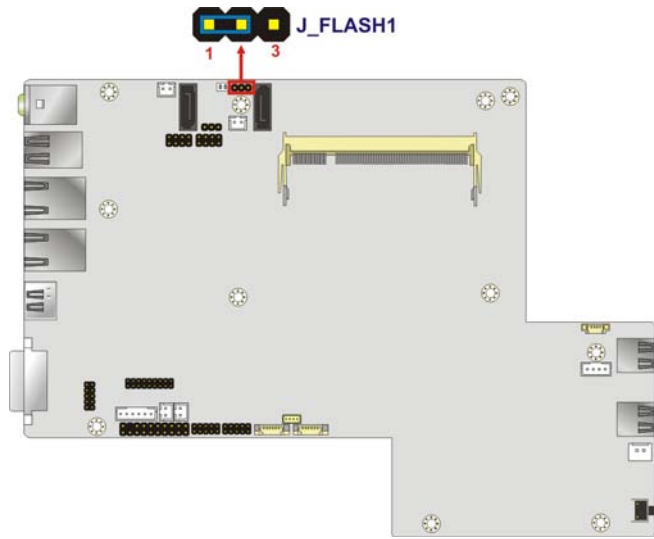


Figure 4-26: Flash Descriptor Security Override Jumper Location





Chapter

5

**BIOS**

---

## 5.1 Introduction

The BIOS is programmed onto the BIOS chip. The BIOS setup program allows changes to certain system settings. This chapter outlines the options that can be changed.

### 5.1.1 Starting Setup

The AMI BIOS is activated when the computer is turned on. The setup program can be activated in one of two ways.

1. Press the **DELETE** key as soon as the system is turned on or
2. Press the **DELETE** key when the “**Press Del to enter SETUP**” message appears on the screen.

If the message disappears before the **DELETE** key is pressed, restart the computer and try again.

### 5.1.2 Using Setup

Use the arrow keys to highlight items, press **ENTER** to select, use the PageUp and PageDown keys to change entries, press **F1** for help and press **ESC** to quit. Navigation keys are shown in.

Key	Function
Up arrow	Move to previous item
Down arrow	Move to next item
Left arrow	Move to the item on the left hand side
Right arrow	Move to the item on the right hand side
Esc key	Main Menu – Quit and not save changes into CMOS Status Page Setup Menu and Option Page Setup Menu -- Exit current page and return to Main Menu
F1 key	General help, only for Status Page Setup Menu and Option Page Setup Menu
F2 key	Load previous values.
F3 key	Load optimized defaults

Key	Function
F4 key	Save all the CMOS changes

**Table 5-1: BIOS Navigation Keys**

### 5.1.3 Getting Help

When **F1** is pressed a small help window describing the appropriate keys to use and the possible selections for the highlighted item appears. To exit the Help Window press **Esc** or the **F1** key again.

### 5.1.4 Unable to Reboot after Configuration Changes

If the computer cannot boot after changes to the system configuration is made, CMOS defaults. Use the jumper described in Chapter 5.

### 5.1.5 BIOS Menu Bar

The **menu bar** on top of the BIOS screen has the following main items:

- Main – Changes the basic system configuration.
- Advanced – Changes the advanced system settings.
- Chipset – Changes the chipset settings.
- Boot – Changes the system boot configuration.
- Security – Sets User and Supervisor Passwords.
- Save & Exit – Selects exit options and loads default settings

The following sections completely describe the configuration options found in the menu items at the top of the BIOS screen and listed above.

## 5.2 Main

The **Main** BIOS menu (**BIOS Menu 1**) appears when the **BIOS Setup** program is entered. The **Main** menu gives an overview of the basic system information.

```

Aptio Setup Utility - Copyright (C) 2011 American Megatrends, Inc.
Main  Advanced  Chipset  Boot  Security  Save & Exit

BIOS Information
BIOS Vendor                American Megatrends
Core Version               4.6.4.0
Compliancy                 UEFI 2.0
Project Version            SE15AR13.ROM
Build Date                 04/23/2012 11:12:46

iWDD Vendor                ICP
iWDD Version               SE15ER12.bin

Memory Information
Total Memory               2048 MB (DDR3 1333)

System Date                [Thu 09/06/2012]
System Time                [14:20:27]

Access Level               Administrator

Set the Time. Use Tab to
switch between Time
elements.

-----
<->: Select Screen
↑ ↓: Select Item
EnterSelect
F1  General Help
F2  Previous Values
F3  Optimized Defaults
F4  Save
ESC Exit

Version 2.14.1219. Copyright (C) 2011 American Megatrends, Inc.

```

### BIOS Menu 1: Main

#### ➔ BIOS Information

The **BIOS Information** lists a brief summary of the BIOS. The fields in **BIOS Information** cannot be changed. The items shown in the system overview include:

- **BIOS Vendor:** Installed BIOS vendor
- **Core Version:** Current BIOS version
- **Compliancy:** Current compliant version
- **Project Version:** the board version
- **Build Date:** Date the current BIOS version was made

#### ➔ iWDD Vendor

- The **iWDD Vendor** displays the installed iWDD vendor. The fields in **iWDD Vendor** cannot be changed.



→ iWDD Version

- The **iWDD Version** displays the current iWDD version. The fields in **iWDD Version** cannot be changed.

→ Memory Information

The **Memory Information** lists a brief summary of the on-board memory. The fields in **Memory Information** cannot be changed.

- Total Memory: Displays the auto-detected system memory size and type.

The System Overview field also has two user configurable fields:

→ System Date [xx/xx/xx]

Use the **System Date** option to set the system date. Manually enter the day, month and year.

→ System Time [xx:xx:xx]

Use the **System Time** option to set the system time. Manually enter the hours, minutes and seconds.

## 5.3 Advanced

Use the **Advanced** menu (**BIOS Menu 2**) to configure the CPU and peripheral devices through the following sub-menus:



### WARNING!

Setting the wrong values in the sections below may cause the system to malfunction. Make sure that the settings made are compatible with the hardware.

---

## ECN-780-Q67 Embedded System

```

Aptio Setup Utility - Copyright (C) 2009 American Megatrends, Inc.
Main  Advanced  Chipset  Boot  Security  Save & Exit

> ACPI Settings
> RTC Wake Settings
> Trusted Computing
> CPU Configuration
> SATA Configuration
> Intel TXT(LT) Configuration
> USB Configuration
> F81866 Super IO Configuration
> F81866 H/M Monitor
> Serial Port Console Redirection
> iEi Feature

System ACPI Parameters
-----
<->: Select Screen
↑↓: Select Item
EnterSelect
F1  General Help
F2  Previous Values
F3  Optimized
Defaults
F4  Save
ESC Exit

Version 2.00.1201. Copyright (C) 2009 American Megatrends, Inc.

```

### BIOS Menu 2: Advanced

#### 5.3.1 ACPI Configuration

The **ACPI Configuration** menu (**BIOS Menu 3**) configures the Advanced Configuration and Power Interface (ACPI) options.

```

Aptio Setup Utility - Copyright (C) 2009 American Megatrends, Inc.
Advanced

ACPI Sleep State          [S1 (CPU Stop Clock)]  Set the ACPI state used
                                                                    for System suspend
-----
<->: Select Screen
↑↓: Select Item
EnterSelect
F1  General Help
F2  Previous Values
F3  Optimized
Defaults
F4  Save
ESC Exit

Version 2.00.1201. Copyright (C) 2009 American Megatrends, Inc.

```

### BIOS Menu 3: ACPI Configuration

➔ **ACPI Sleep State [S1 (CPU Stop Clock)]**

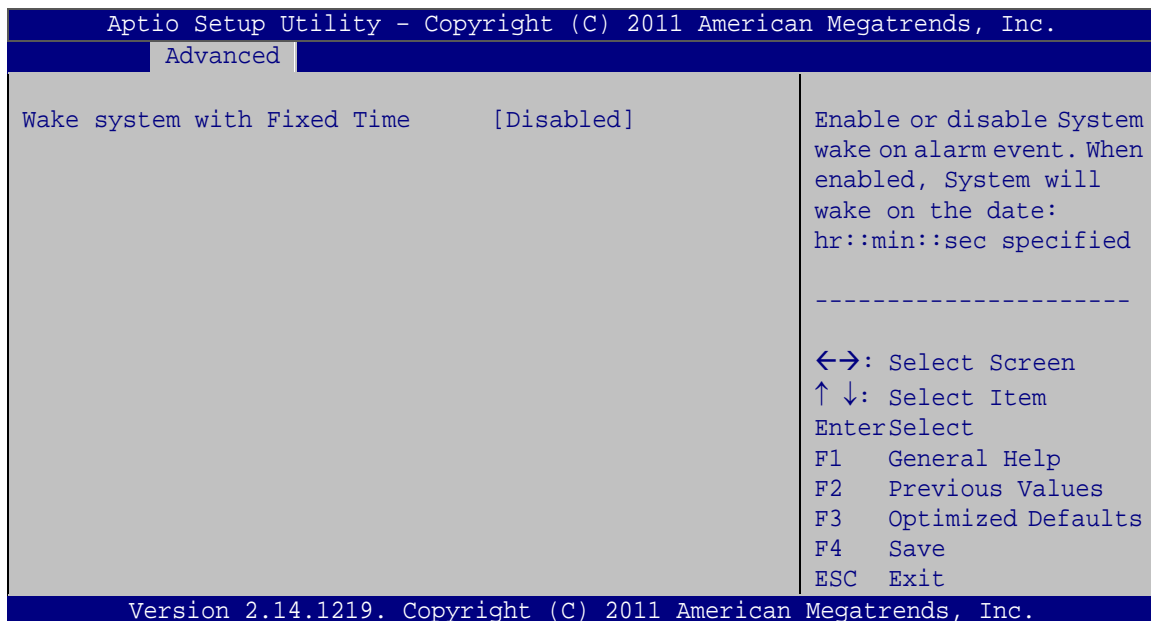
Use the **ACPI Sleep State** option to specify the sleep state the system enters when it is not being used.

➔ **S1 (CPU Stop Clock)** **DEFAULT** The system enters S1 (POS) sleep state. The system appears off. The CPU is stopped; RAM is refreshed; the system is running in a low power mode.

➔ **S3 (Suspend to RAM)** The caches are flushed and the CPU is powered off. Power to the RAM is maintained. The computer returns slower to a working state, but more power is saved.

### 5.3.2 RTC Wake Settings

The **RTC Wake Settings** menu (**BIOS Menu 4**) configures RTC wake event.



#### **BIOS Menu 4: RTC Wake Settings**

➔ **Wake system with Fixed Time [Disabled]**

Use the **Wake system with Fixed Time** option to enable or disable the system wake on alarm event.

## ECN-780-Q67 Embedded System

→ **Disabled**    **DEFAULT**    The real time clock (RTC) cannot generate a wake event

→ **Enabled**    If selected, the **Wake up every day** option appears allowing you to enable to disable the system to wake every day at the specified time. Besides, the following options appear with values that can be selected:

Wake up date

Wake up hour

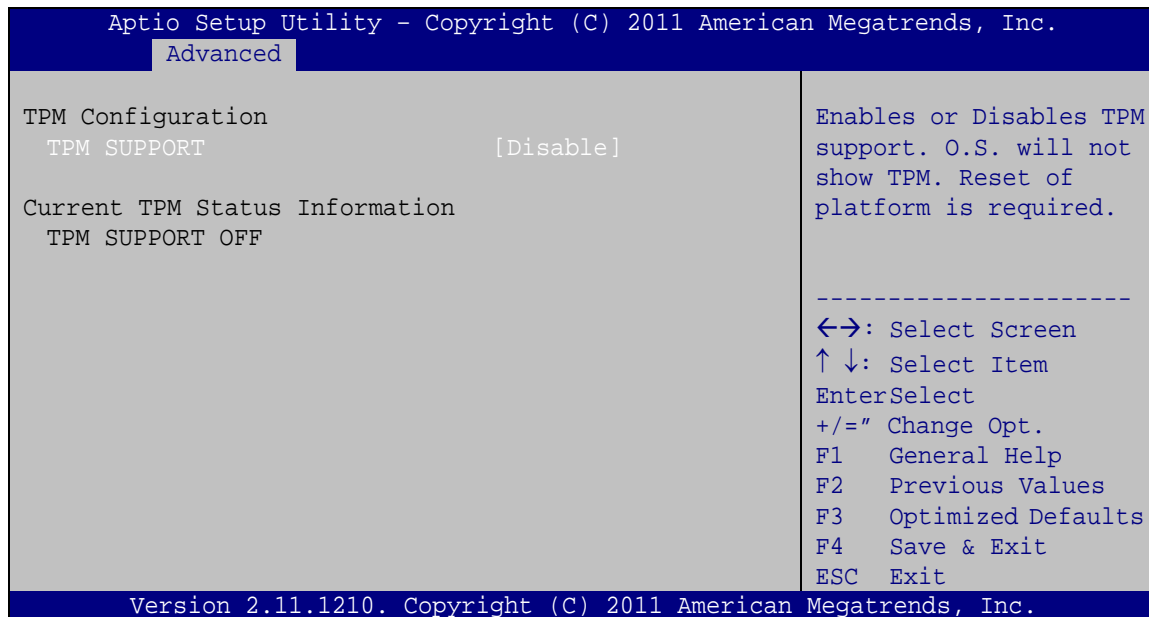
Wake up minute

Wake up second

After setting the alarm, the computer turns itself on from a suspend state when the alarm goes off.

### 5.3.3 Trusted Computing

Use the **Trusted Computing** menu (**BIOS Menu 5**) to configure settings related to the Trusted Computing Group (TCG) Trusted Platform Module (TPM).



**BIOS Menu 5: TPM Configuration**



→ TPM Support [Disable]

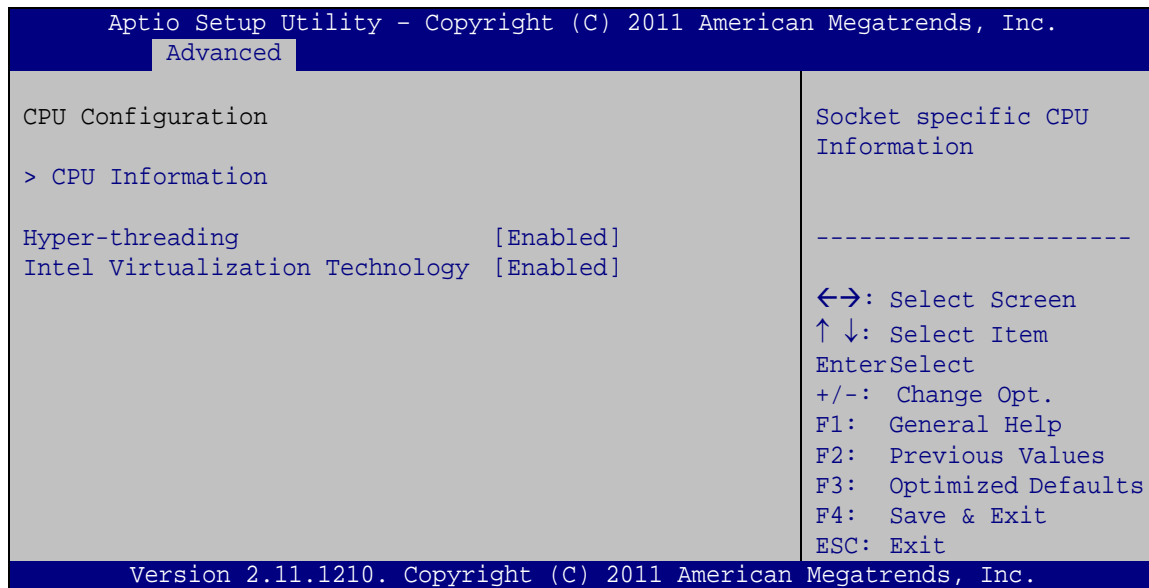
Use the **TPM Support** option to configure support for the TPM.

→ **Disable** **DEFAULT** TPM support is disabled.

→ **Enable** TPM support is enabled.

### 5.3.4 CPU Configuration

Use the **CPU Configuration** menu (**BIOS Menu 6**) to enter the **CPU Information** submenu or enable Intel Virtualization Technology.



#### BIOS Menu 6: CPU Configuration

→ Hyper-threading [Enabled]

Use the Hyper-threading function to enable or disable the CPU hyper threading function.

→ **Disabled** Disables the use of hyper-threading technology

→ **Enabled** **DEFAULT** Enables the use of hyper-threading technology

## ECN-780-Q67 Embedded System

### → Intel Virtualization Technology [Enabled]

Use the **Intel Virtualization Technology** option to enable or disable virtualization on the system. When combined with third party software, Intel Virtualization technology allows several OSs to run on the same system at the same time.

→ **Disabled** Disables Intel Virtualization Technology.

→ **Enabled** **DEFAULT** Enables Intel Virtualization Technology.

### 5.3.4.1 CPU Information

Use the **CPU Information** submenu (**BIOS Menu 7**) to view detailed CPU specifications and configure the CPU.

```

Aptio Setup Utility - Copyright (C) 2011 American Megatrends, Inc.
  Advanced
CPU Information

Intel(R) Core(TM) i3-2100T CPU @ 2.50GHz
CPU Signature                206a7
Microcode Patch              1b
Max CPU Speed                2500 MHz
Min CPU Speed                1600 MHz
Processor Cores              2
Intel HT Technology          Supported
Intel VT-x Technology        Supported
Intel SMX Technology         Supported

L1 Data Cache                32 kB x 2
L1 Code Cache                32 kB x 2
L2 Cache                     256 kB x 2
L3 Cache                     3072 kB

-----
←→: Select Screen
↑ ↓: Select Item
Enter>Select
+/-: Change Opt.
F1: General Help
F2: Previous Values
F3: Optimized Defaults
F4: Save & Exit
ESC: Exit

Version 2.11.1210. Copyright (C) 2011 American Megatrends, Inc.
  
```

### BIOS Menu 7: CPU Configuration

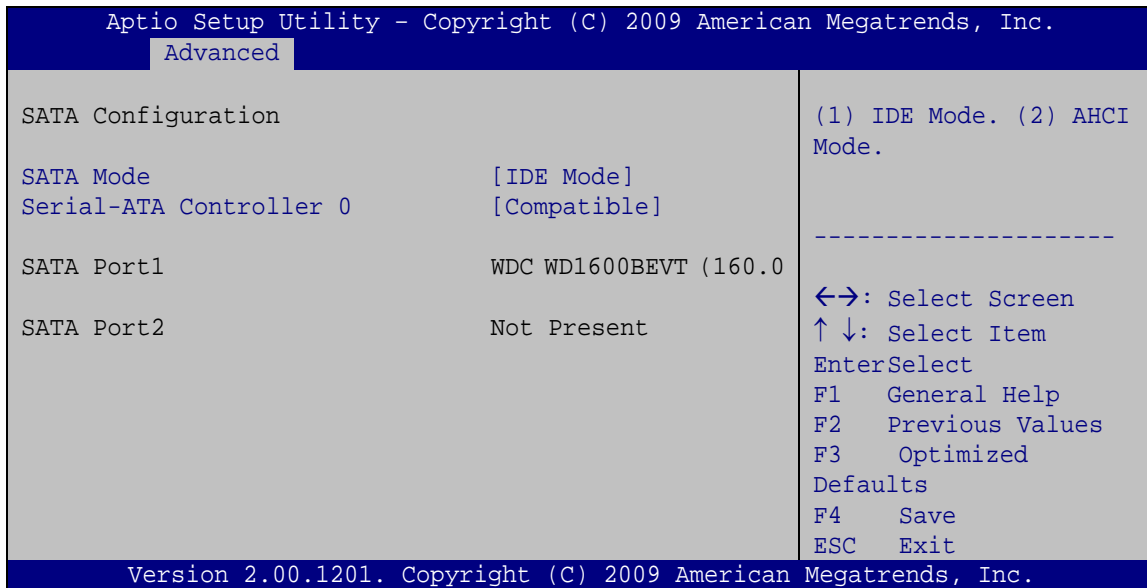
The CPU Configuration menu (**BIOS Menu 7**) lists the following CPU details:

- Processor Type: Lists the brand name of the CPU being used
- CPU Signature: Lists the CPU signature value.
- Microcode Patch: Lists the microcode patch being used.
- Max CPU Speed: Lists the maximum CPU processing speed.
- Min CPU Speed: Lists the minimum CPU processing speed.

- Processor Cores: Lists the number of the processor core
- Intel HT Technology: Indicates if Intel HT Technology is supported by the CPU.
- Intel VT-x Technology: Indicates if Intel VT-x Technology is supported by the CPU.
- Intel SMX Technology: Indicates if Intel SMX Technology is supported by the CPU.
- L1 Data Cache: Lists the amount of data storage space on the L1 cache.
- L1 Code Cache: Lists the amount of code storage space on the L1 cache.
- L2 Cache: Lists the amount of storage space on the L2 cache.
- L3 Cache: Lists the amount of storage space on the L3 cache.

### 5.3.5 SATA Configuration

Use the **SATA Configuration** menu (**BIOS Menu 8**) to change and/or set the configuration of the SATA devices installed in the system.



#### BIOS Menu 8: IDE Configuration

➔ SATA Mode [IDE Mode]

Use the **SATA Mode** option to configure SATA devices as normal IDE devices.

➔ **IDE Mode**    **DEFAULT**    Configures SATA devices as normal IDE device.

➔ **AHCI Mode** Configures SATA devices as AHCI device.

➔ Serial-ATA Controller 0 [Compatible]

Use the **Serial-ATA Controller** option to configure the Serial-ATA controller mode when the SATA mode is set to IDE Mode.

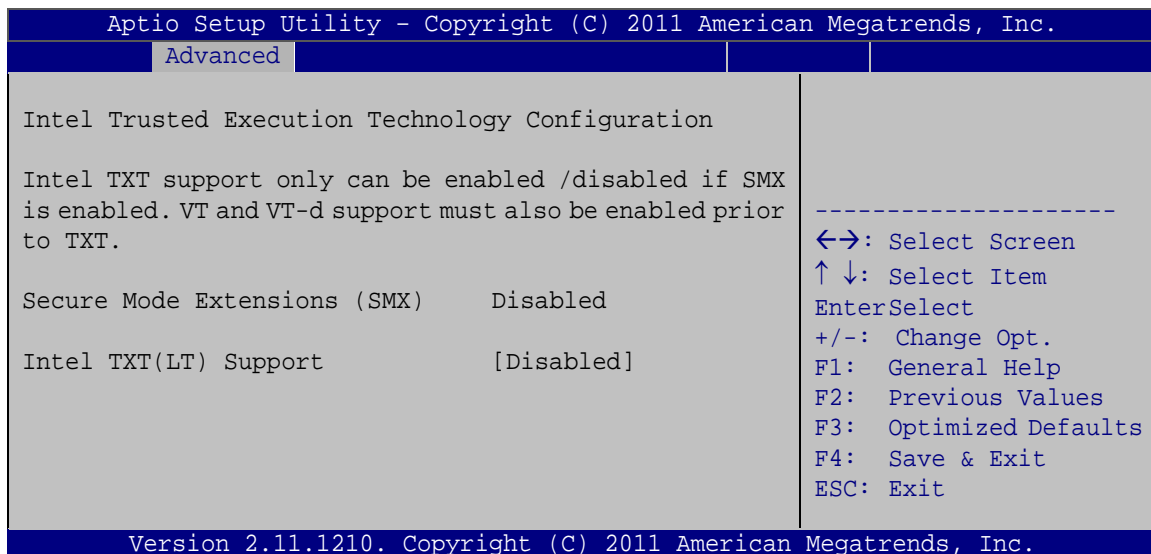
➔ **Disable** Disables Serial-ATA controller.

➔ **Enhanced** Configures the Serial-ATA controller to be in enhanced mode. In this mode, IDE channels and SATA channels are separated. Some legacy OS do not support this mode.

➔ **Compatible** **DEFAULT** Configures the Serial-ATA controller to be in compatible mode. In this mode, a SATA channel will replace one of the IDE channels.

### 5.3.6 Intel TXT (LT) Configuration

Use the **Intel TXT (LT) Configuration** menu (**BIOS Menu 9**) to configure Intel Trusted Execution Technology support.

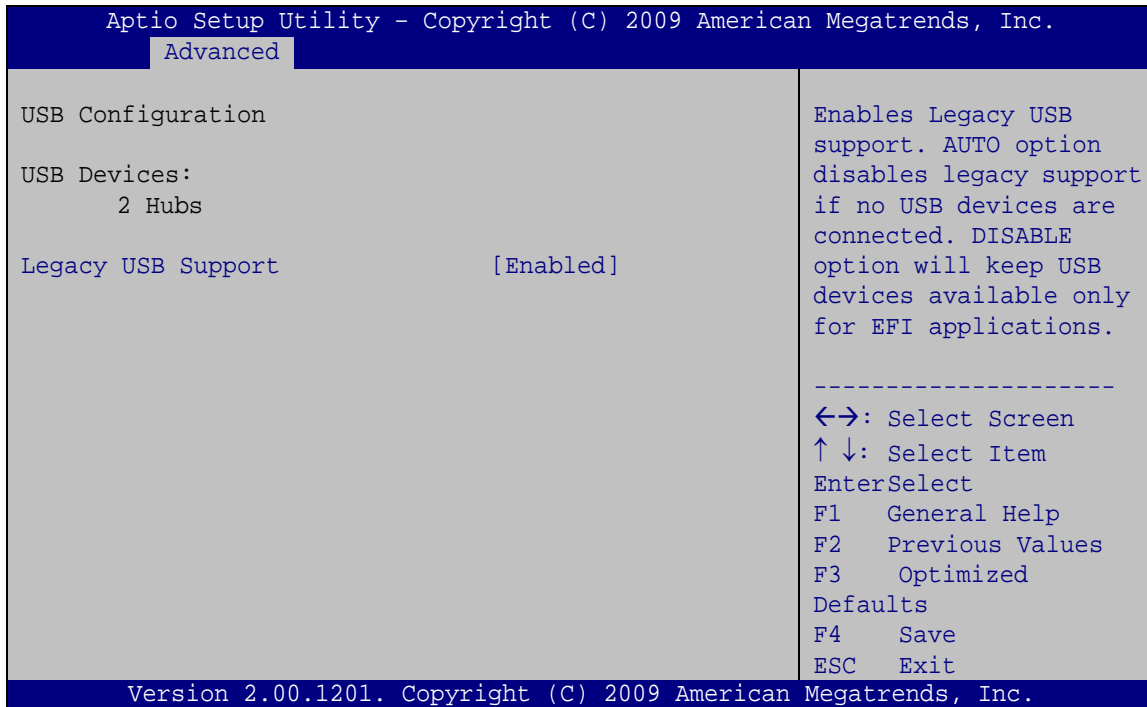


**BIOS Menu 9: Intel TXT(LT) Configuration**



### 5.3.7 USB Configuration

Use the **USB Configuration** menu (**BIOS Menu 10**) to read USB configuration information and configure the USB settings.



#### BIOS Menu 10: USB Configuration

##### ➔ USB Devices

The **USB Devices Enabled** field lists the USB devices that are enabled on the system

##### ➔ Legacy USB Support [Enabled]

Use the **Legacy USB Support** BIOS option to enable USB mouse and USB keyboard support. Normally if this option is not enabled, any attached USB mouse or USB keyboard does not become available until a USB compatible operating system is fully booted with all USB drivers loaded. When this option is enabled, any attached USB mouse or USB keyboard can control the system even when there is no USB driver loaded onto the system.

➔ **Disabled** Legacy USB support disabled

## ECN-780-Q67 Embedded System

- ➔ **Enabled**      **DEFAULT**      Legacy USB support enabled
- ➔ **Auto**                      Legacy USB support disabled if no USB devices are connected

### 5.3.8 F81866 Super IO Configuration

Use the **F81866 Super IO Configuration** menu (**BIOS Menu 11**) to set or change the configurations for the FDD controllers, parallel ports and serial ports.

```

Aptio Setup Utility - Copyright (C) 2009 American Megatrends, Inc.
  Advanced
F81866 Super IO Configuration
F81866 Super IO Chip          F81866
> Serial Port 1 Configuration
> Serial Port 2 Configuration
> Serial Port 3 Configuration
> Serial Port 4 Configuration
> Serial Port 5 Configuration

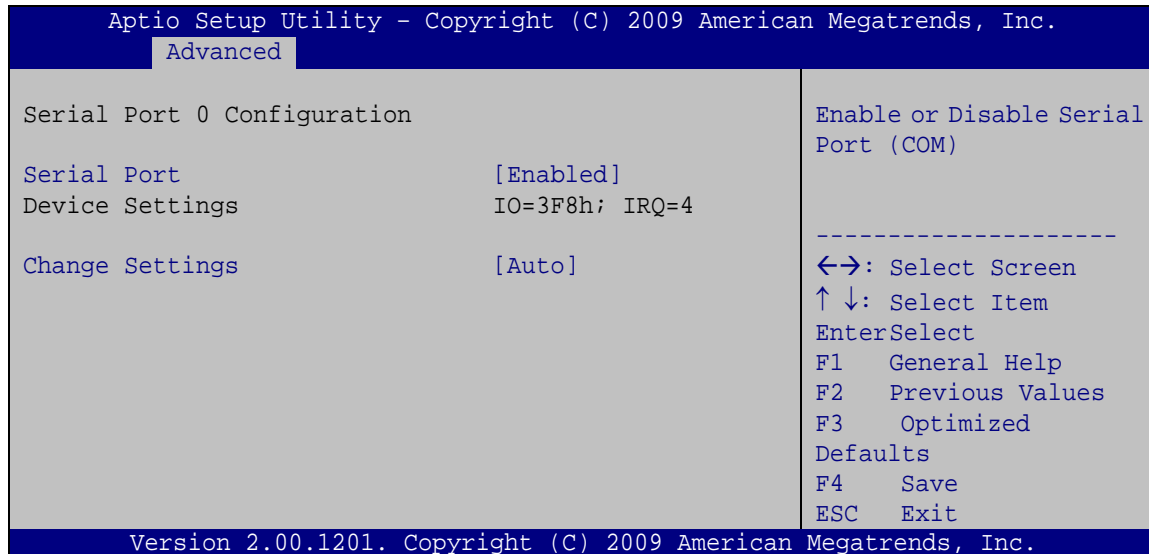
Set Parameters of Serial
Port 1 (COMA)
-----
<->: Select Screen
↑ ↓: Select Item
Enter Select
F1   General Help
F2   Previous Values
F3   Optimized
Defaults
F4   Save
ESC  Exit

Version 2.00.1201. Copyright (C) 2009 American Megatrends, Inc.
  
```

**BIOS Menu 11: Super IO Configuration**

### 5.3.8.1 Serial Port n Configuration

Use the **Serial Port n Configuration** menu (**BIOS Menu 12**) to configure the serial port n.



#### BIOS Menu 12: Serial Port n Configuration Menu

##### 5.3.8.1.1 Serial Port 1 Configuration

###### → Serial Port [Enabled]

Use the **Serial Port** option to enable or disable the serial port.

- **Disabled** Disable the serial port
- **Enabled** **DEFAULT** Enable the serial port

###### → Change Settings [Auto]

Use the **Change Settings** option to change the serial port IO port address and interrupt address.

- **Auto** **DEFAULT** The serial port IO port address and interrupt address are automatically detected.
- **IO=3F8h;**  
**IRQ=4** Serial Port I/O port address is 3F8h and the interrupt address is IRQ4

- ➔ **IO=3F8h;**  
**IRQ=3, 4**                      Serial Port I/O port address is 3F8h and the interrupt address is IRQ3, 4
- ➔ **IO=2F8h;**  
**IRQ=3, 4**                      Serial Port I/O port address is 2F8h and the interrupt address is IRQ3, 4
- ➔ **IO=3E8h;**  
**IRQ=3, 4**                      Serial Port I/O port address is 3E8h and the interrupt address is IRQ3, 4
- ➔ **IO=2E8h;**  
**IRQ=3, 4**                      Serial Port I/O port address is 2E8h and the interrupt address is IRQ3, 4

### 5.3.8.1.2 Serial Port 2 Configuration

#### ➔ Serial Port [Enabled]

Use the **Serial Port** option to enable or disable the serial port.

- ➔ **Disabled**                      Disable the serial port
- ➔ **Enabled**                      **DEFAULT**                      Enable the serial port

#### ➔ Change Settings [Auto]

Use the **Change Settings** option to change the serial port IO port address and interrupt address.

- ➔ **Auto**                      **DEFAULT**                      The serial port IO port address and interrupt address are automatically detected.
- ➔ **IO=2F8h;**  
**IRQ=3**                      Serial Port I/O port address is 2F8h and the interrupt address is IRQ3
- ➔ **IO=3F8h;**  
**IRQ=3, 4**                      Serial Port I/O port address is 3F8h and the interrupt address is IRQ3, 4
- ➔ **IO=2E8h;**  
**IRQ=3, 4**                      Serial Port I/O port address is 2E8h and the interrupt address is IRQ3, 4
- ➔ **IO=3E8h;**  
**IRQ=3, 4**                      Serial Port I/O port address is 3E8h and the interrupt address is IRQ3, 4



- ➔ **IO=2E8h;**                      Serial Port I/O port address is 2E8h and the interrupt  
**IRQ=3, 4**                      address is IRQ3, 4

### 5.3.8.1.3 Serial Port 3 Configuration

- ➔ Serial Port [Enabled]

Use the **Serial Port** option to enable or disable the serial port.

- ➔ **Disabled**                      Disable the serial port
- ➔ **Enabled**                      **DEFAULT**                      Enable the serial port

- ➔ Change Settings [Auto]

Use the **Change Settings** option to change the serial port IO port address and interrupt address.

- ➔ **Auto**                      **DEFAULT**                      The serial port IO port address and interrupt address are automatically detected.
- ➔ **IO=3E8h;**                      Serial Port I/O port address is 3E8h and the interrupt  
**IRQ=7**                      address is IRQ7
- ➔ **IO=3F8h;**                      Serial Port I/O port address is 3F8h and the interrupt  
**IRQ=7, 10**                      address is IRQ7, 10
- ➔ **IO=2F8h;**                      Serial Port I/O port address is 2F8h and the interrupt  
**IRQ=7, 10**                      address is IRQ7, 10
- ➔ **IO=3E8h;**                      Serial Port I/O port address is 3E8h and the interrupt  
**IRQ=7, 10**                      address is IRQ7, 10
- ➔ **IO=2E8h;**                      Serial Port I/O port address is 2E8h and the interrupt  
**IRQ=7, 10**                      address is IRQ7, 10

## ECN-780-Q67 Embedded System

### 5.3.8.1.4 Serial Port 4 Configuration

#### → Serial Port [Enabled]

Use the **Serial Port** option to enable or disable the serial port.

- **Disabled**                      Disable the serial port
- **Enabled**      **DEFAULT**      Enable the serial port

#### → Change Settings [Auto]

Use the **Change Settings** option to change the serial port IO port address and interrupt address.

- **Auto**              **DEFAULT**      The serial port IO port address and interrupt address are automatically detected.
- **IO=2E8h;**  
**IRQ=10**                      Serial Port I/O port address is 2E8h and the interrupt address is IRQ10
- **IO=3F8h;**  
**IRQ=7, 10**                      Serial Port I/O port address is 3F8h and the interrupt address is IRQ7, 10
- **IO=2F8h;**  
**IRQ=7, 10**                      Serial Port I/O port address is 2F8h and the interrupt address is IRQ7, 10
- **IO=3E8h;**  
**IRQ=7, 10**                      Serial Port I/O port address is 3E8h and the interrupt address is IRQ7, 10
- **IO=2E8h;**  
**IRQ=7, 10**                      Serial Port I/O port address is 2E8h and the interrupt address is IRQ7, 10

### 5.3.8.1.5 Serial Port 5 Configuration

#### → Serial Port [Enabled]

Use the **Serial Port** option to enable or disable the serial port.

- **Disabled**                      Disable the serial port

→ **Enabled**      **DEFAULT**      Enable the serial port

→ Change Settings [Auto]

Use the **Change Settings** option to change the serial port IO port address and interrupt address.

→ **Auto**      **DEFAULT**      The serial port IO port address and interrupt address are automatically detected.

→ **IO=2C0h;**  
**IRQ=11**      Serial Port I/O port address is 2C0h and the interrupt address is IRQ11

→ **IO=2C0h;**  
**IRQ=10, 11**      Serial Port I/O port address is 2C0h and the interrupt address is IRQ10, 11

→ **IO=2C8h;**  
**IRQ=10, 11**      Serial Port I/O port address is 2C8h and the interrupt address is IRQ10, 11

→ **IO=3E8h;**  
**IRQ=10, 11**      Serial Port I/O port address is 3E8h and the interrupt address is IRQ10, 11

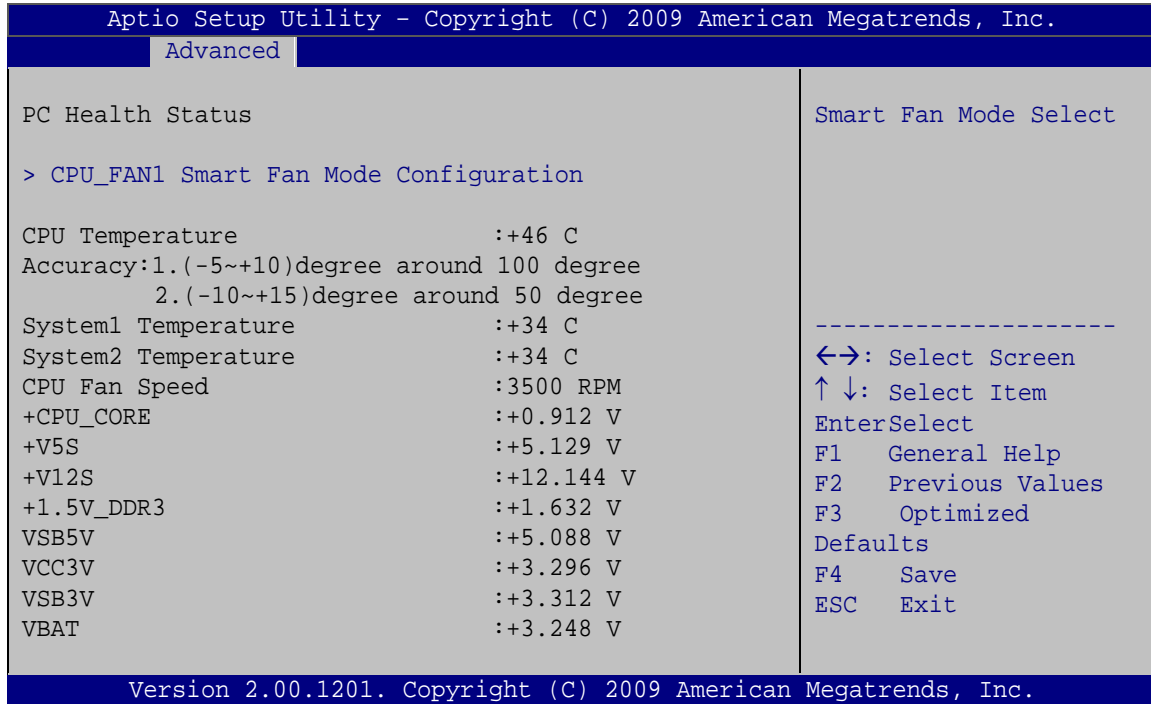
→ **IO=2E8h;**  
**IRQ=10, 11**      Serial Port I/O port address is 2E8h and the interrupt address is IRQ10, 11

→ Device Mode [RS422/485]

The **Device Mode** shows Serial Port 5 provides RS-422/485 communications.

### 5.3.9 F81866 H/W Monitor

The H/W Monitor menu (**BIOS Menu 13**) shows the operating temperature, fan speeds and system voltages.



**BIOS Menu 13: Hardware Health Configuration**

➔ PC Health Status

The following system parameters and values are shown. The system parameters that are monitored are:

- System Temperatures:
  - CPU Temperature
  - System1 Temperature
  - System2 Temperature
- Fan Speeds:
  - CPU Fan Speed
- Voltages:
  - +CPU\_CORE
  - +V5S
  - +V12S
  - +1.5V\_DDR3
  - VSB5V
  - VCC3V
  - VSB3V



- VBAT

### 5.3.9.1 Smart Fan Mode Configuration

Use the Smart Fan Mode Configuration menu (**BIOS Menu 14**) to configure the CPU fan.

```

Aptio Setup Utility - Copyright (C) 2009 American Megatrends, Inc.
-----
Advanced
-----
CPU_FAN1 Smart Fan Mode Configuration
CPU Smart Fan control          [Auto PWM Mode]
Temperature of Start           75
Temperature of Off             80
Start PWM                      30
Slope(Duty Cycle)             [4]

CPU Smart Fan control settings.

-----
<=>: Select Screen
↑ ↓: Select Item
Enter>Select
F1   General Help
F2   Previous Values
F3   Optimized
Defaults
F4   Save
ESC  Exit

Version 2.00.1201. Copyright (C) 2009 American Megatrends, Inc.
    
```

#### BIOS Menu 14: Hardware Health Configuration

- ➔ CPU Smart Fan control [Auto PWM Mode]

Use the **CPU Smart Fan control** BIOS option to configure the CPU Smart Fan.

- ➔ **Full Mode**                      Fan is on all the time
- ➔ **Manual      PWM**              The fan spins at the speed set in the manual PWM setting
- ➔ **Auto PWM Mode      DEFAULT**      The fan adjusts its speed using these settings:
  - Temperature of Start
  - Temperature of Off
  - Start PWM
  - Slope (Duty Cycle)

---

→ Temperature of Start [75]

---



**WARNING:**

Setting this value too high may cause the fan to rotate at full speed only when the CPU is at a very high temperature and therefore cause the system to be damaged.

---

The **Temperature of Start** option can only be set if the **CPU Smart Fan control** option is set to **Auto Mode**. When the **CPU Temperature** is higher than **Temperature of Start**, the fan will be rotate at full speed. To set a value, select the **Temperature of Start** option and enter a decimal number between 0 and 127. The temperature range is specified below.

- Minimum Value: 0°C
- Maximum Value: 127°C

---

→ Temperature of Off [80]

---



**WARNING:**

Setting this value too high may cause the fan to speed up only when the CPU is at a very high temperature and therefore cause the system to be damaged.

---

The **Temperature of Off** option can only be set if the **CPU Smart Fan control** option is set to **Auto Mode**. When the **CPU Temperature** is higher than **Temperature of Off**, the fan will be speed up. To set a value, select the **Temperature of Off** option and enter a decimal number between 0 and 127. The temperature range is specified below.

- Minimum Value: 0°C
- Maximum Value: 127°C

---

→ Start PWM [30]

The **Start PWM** option can only be set if the **CPU Smart Fan control** option is set to **Auto Mode**. Use the **Start PWM** option to set the PWM start value. To set a value, select the **Start PWM** option and enter a decimal number between 0 and 100. The temperature range is specified below.

- Minimum Value: 0
- Maximum Value: 100

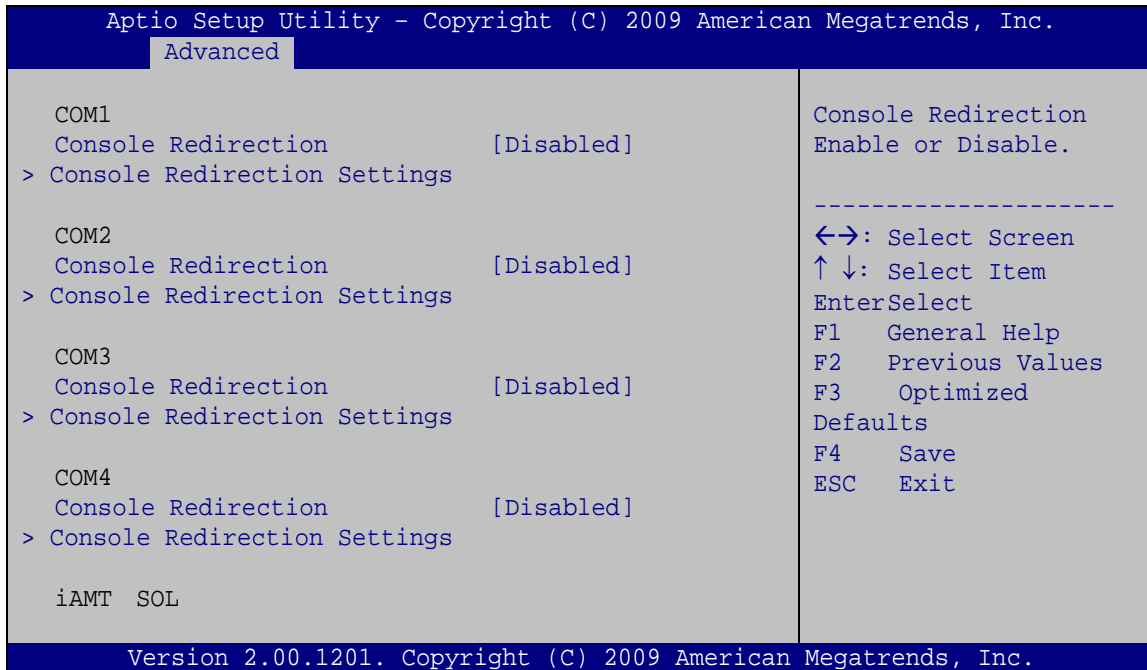
➔ Slope (Duty Cycle) [4]

The **Slope (Duty Cycle)** option can only be set if the **CPU Smart Fan control** option is set to **Auto Mode**. Use the **Slope (Duty Cycle)** option to select the linear rate at which the PWM mode increases with respect to an increase in temperature. A list of available options is shown below:

- 0
- 1
- 2
- 4
- 8
- 16

### 5.3.10 Serial Port Console Redirection

The **Serial Port Console Redirection** menu (**BIOS Menu 15**) allows the console redirection options to be configured. Console redirection allows users to maintain a system remotely by re-directing keyboard input and text output through the serial port.



### BIOS Menu 15: Serial Port Console Redirection

#### → Console Redirection

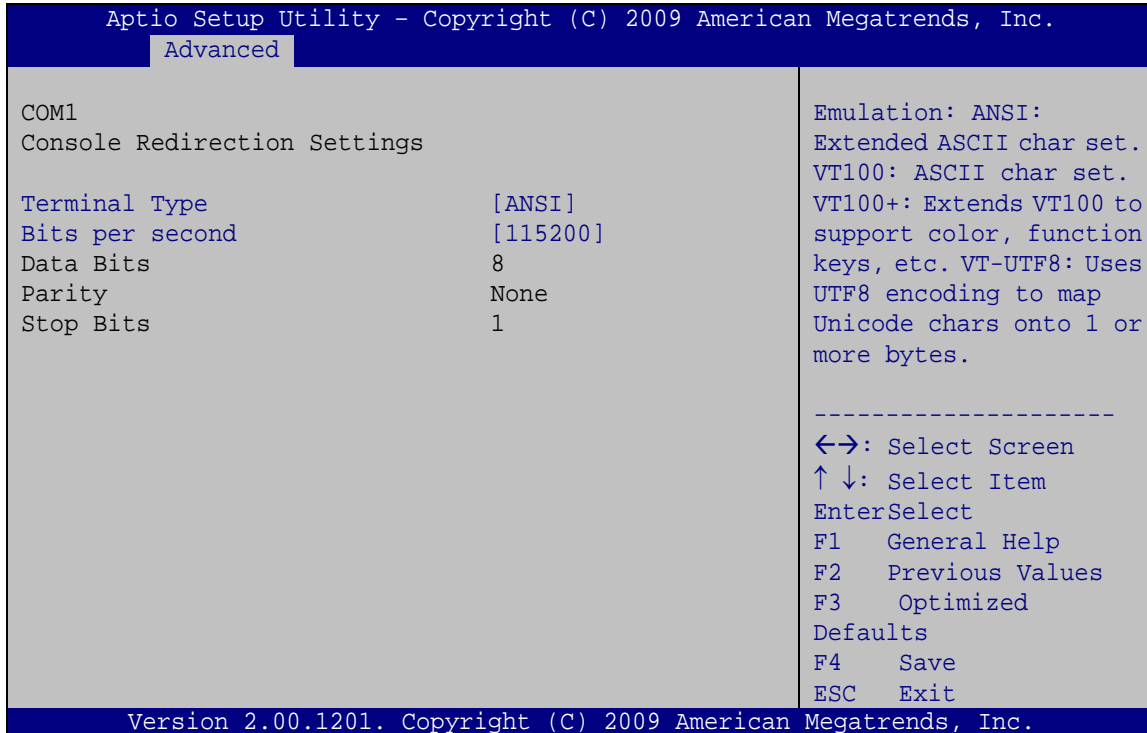
Use **Console Redirection** option to enable or disable the console redirection function.

- **Disabled**    **DEFAULT**    Disables the console redirection function.
- **Enabled**                    Enabled the console redirection function.

#### 5.3.10.1 Console Redirection Settings

The **Console Redirection Settings** menu (**BIOS Menu 16**) allows the console redirection options to be configured. The option is active when Console Redirection option is enabled.





### BIOS Menu 16: Console Redirection Settings

#### → Terminal Type [ANSI]

Use the **Terminal Type** option to specify the remote terminal type..

- **VT100**                      The target terminal type is VT100
- **VT100+**                    The target terminal type is VT100+
- **VT-UTF8**                    The target terminal type is VT-UTF8
- **ANSI**                      **DEFAULT**      The target terminal type is ANSI

#### → Bits per second [115200]

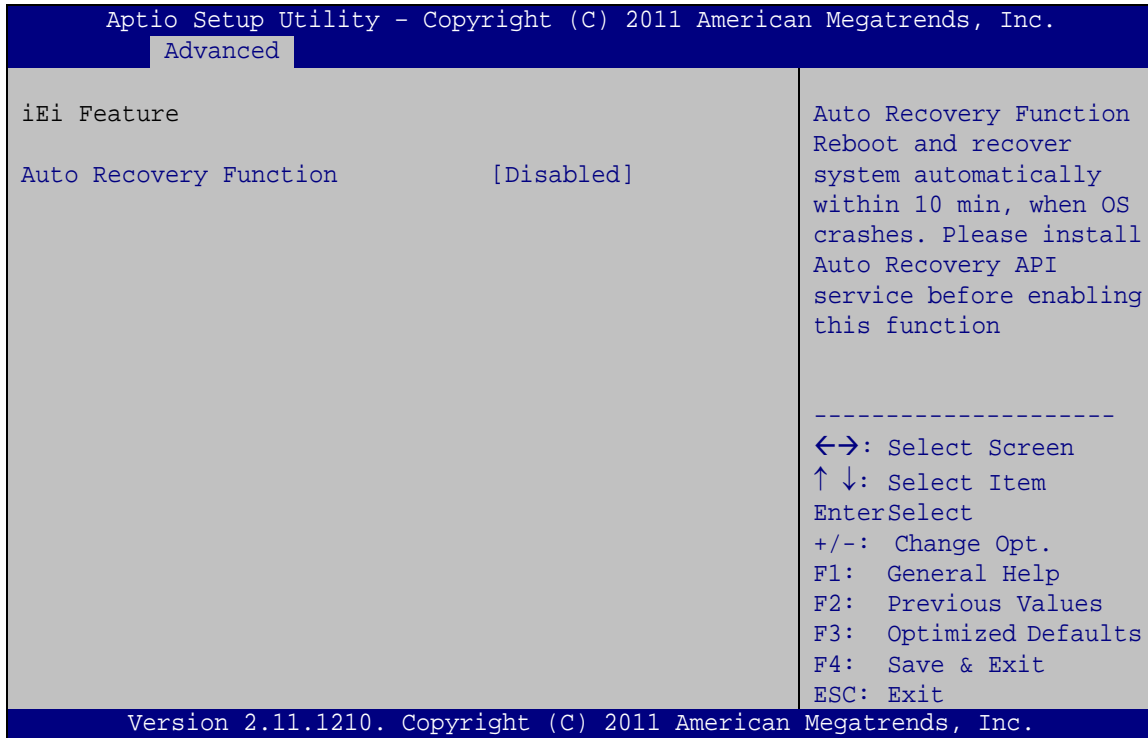
Use the **Bits per second** option to specify the transmission speed of the serial port.

- **9600**                        The transmission speed is 9600
- **19200**                      The transmission speed is 19200
- **38400**                      The transmission speed is 38400

- ➔ **57600**                      The transmission speed is 57600
- ➔ **115200**            **DEFAULT**            The transmission speed is 115200

### 5.4 iEi Feature

Use the **iEi Feature** menu (**BIOS Menu 17**) to configure the auto recovery function.



#### BIOS Menu 17: iEi Feature

- ➔ Auto Recovery Function [Disabled]

Use the **Auto Recovery Function** option to enable or disable auto recovery on the system.

- ➔ **Disabled**            **DEFAULT**            Auto Recovery Function support disabled
- ➔ **Enabled**                      Auto Recovery Function support enabled

## 5.5 Chipset

Use the **Chipset** menu (**BIOS Menu 18**) to access the Northbridge and Southbridge configuration menus



### WARNING!

Setting the wrong values for the Chipset BIOS selections in the Chipset BIOS menu may cause the system to malfunction.

```

Aptio Setup Utility - Copyright (C) 2009 American Megatrends, Inc.
Main   Advanced  Chipset  Boot   Security  Save & Exit
-----
> North Bridge          North Bridge Parameters
> South Bridge
> Intel IGD SWSCI OpRegion
> ME Subsystem

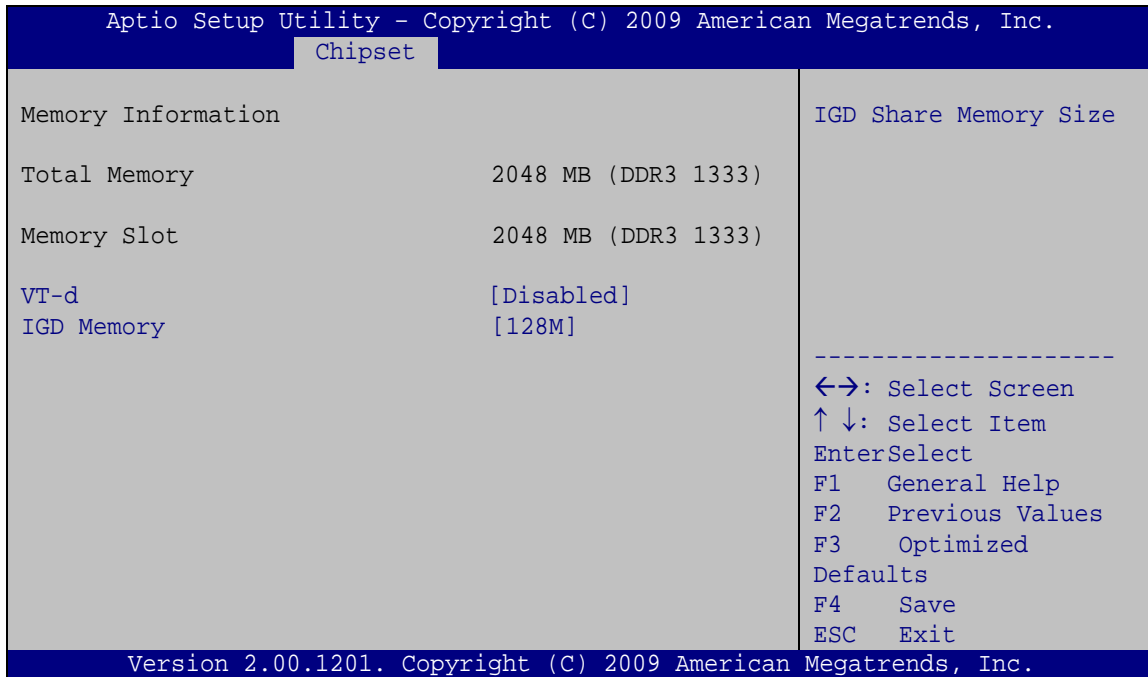
-----
<=>: Select Screen
↑↓: Select Item
Enter>Select
F1   General Help
F2   Previous Values
F3   Optimized
Defaults
F4   Save
ESC  Exit

Version 2.00.1201. Copyright (C) 2009 American Megatrends, Inc.
    
```

**BIOS Menu 18: Chipset**

### 5.5.1 Northbridge Configuration

Use the **Northbridge Chipset Configuration** menu (**BIOS Menu 19**) to configure the Northbridge chipset.



#### BIOS Menu 19:Northbridge Chipset Configuration

➔ VT-d [Disabled]

Use the **VT-d** option to enable or disable VT-d support.

➔ **Disabled**                      **DEFAULT**      Disables VT-d support.

➔ **Enabled**                                      Enables VT-d support.

➔ IGD Memory [128M]

Use the **IGD Memory** option to specify the amount of system memory that can be used by the internal graphics device.

➔ **32 M**                                      32 MB of memory used by internal graphics device

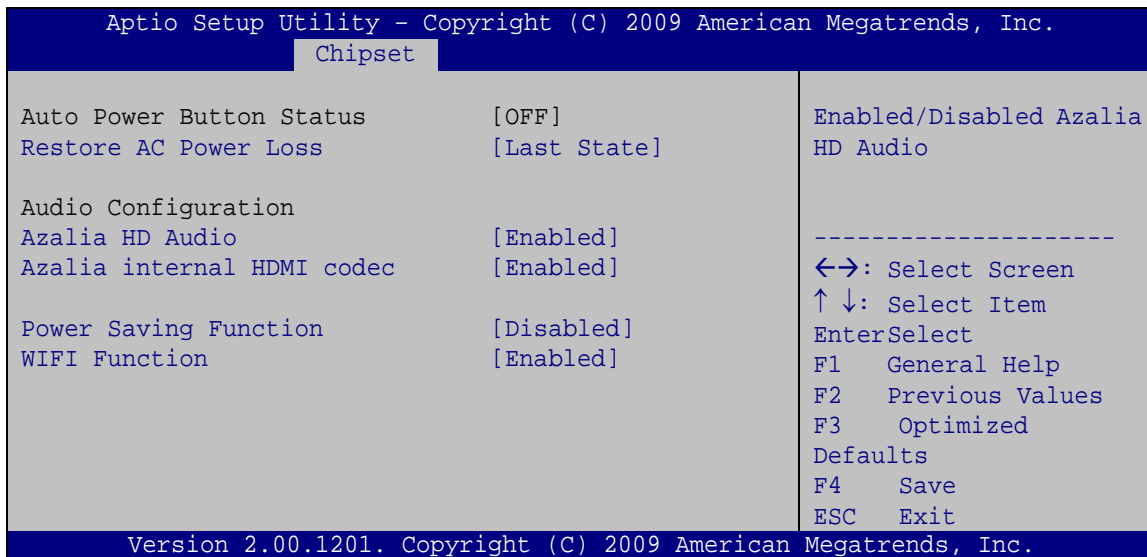
➔ **64 M**                                      64 MB of memory used by internal graphics device



- ➔ **128 M**                      **DEFAULT**    128 MB of memory used by internal graphics device
- ➔ **256 M**                                           256 MB of memory used by internal graphics device
- ➔ **512 M**                                           512 MB of memory used by internal graphics device

### 5.5.2 Southbridge Configuration

Use the **Southbridge Configuration** menu (**BIOS Menu 20**) to configure the Southbridge chipset.



#### BIOS Menu 20: Southbridge Chipset Configuration

- ➔ Restore AC Power Loss [Last State]

Use the **Restore on AC Power Loss** option to specify what state the system returns to if there is a sudden loss of power to the system.

- ➔ **Power Off**                      The system remains turned off
- ➔ **Power On**                      The system turns on
- ➔ **Last State**    **DEFAULT**    The system returns to its previous state. If it was on, it turns itself on. If it was off, it remains off.

## ECN-780-Q67 Embedded System

### → Azalia HD Audio [Enabled]

Use the **Azalia HD Audio** option to enable or disable the High Definition Audio controller.

- **Disabled**                      The onboard High Definition Audio controller is disabled
- **Enabled**    **DEFAULT**      The onboard High Definition Audio controller automatically detected and enabled

### → Azalia internal HDMI codec [Enabled]

Use the **Azalia internal HDMI codec** option to enable or disable the internal HDMI codec for High Definition Audio.

- **Disabled**                      Disables the internal HDMI codec for High Definition Audio
- **Enabled**    **DEFAULT**      Enables the internal HDMI codec for High Definition Audio

### → Power Saving Function [Disabled]

Use the **Power Saving Function** BIOS option to enable or reduce power consumption in the S5 state. When enabled, the system can only be powered-up using the power button.

- **Disabled**    **DEFAULT**      Power saving function support disabled
- **Enabled**                      Power saving function support enabled

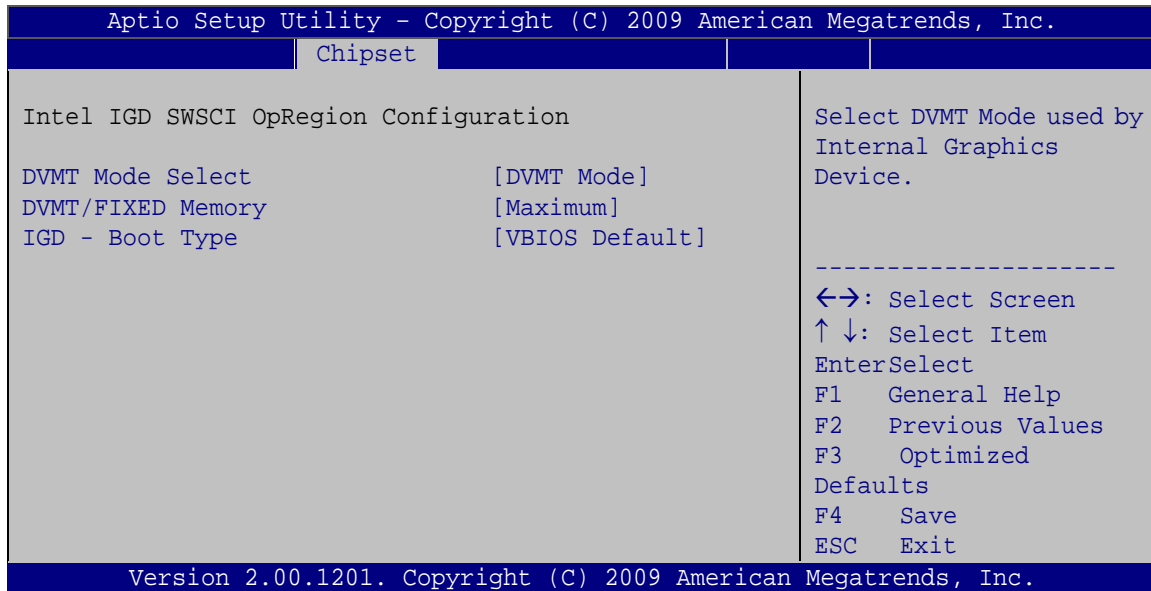
### → WIFI Function [Enabled]

Use the **WIFI Function** option to enable or disable the Wi-Fi function.

- **Disabled**                      Wi-Fi function disabled
- **Enabled**    **DEFAULT**      Wi-Fi function enabled

### 5.5.3 Intel IGD SWSCI OpRegion

Use the **Intel IGD SWSCI OpRegion** menu to configure the video device connected to the system.



#### BIOS Menu 21: Intel IGD SWSCI OpRegion

##### → DVMT Mode Select [DVMT Mode]

Use the **DVMT Mode Select** option to select the Intel Dynamic Video Memory Technology (DVMT) operating mode.

- **Fixed Mode**                      A fixed portion of graphics memory is reserved as graphics memory.
- **DVMT Mode**    **DEFAULT**      Graphics memory is dynamically allocated according to the system and graphics needs.

##### → DVMT Memory [Maximum]

Use the **DVMT Memory** option to specify the maximum amount of memory that can be allocated as graphics memory. Configuration options are listed below.

- 128 MB
- 256 MB

## ECN-780-Q67 Embedded System

- Maximum **DEFAULT**

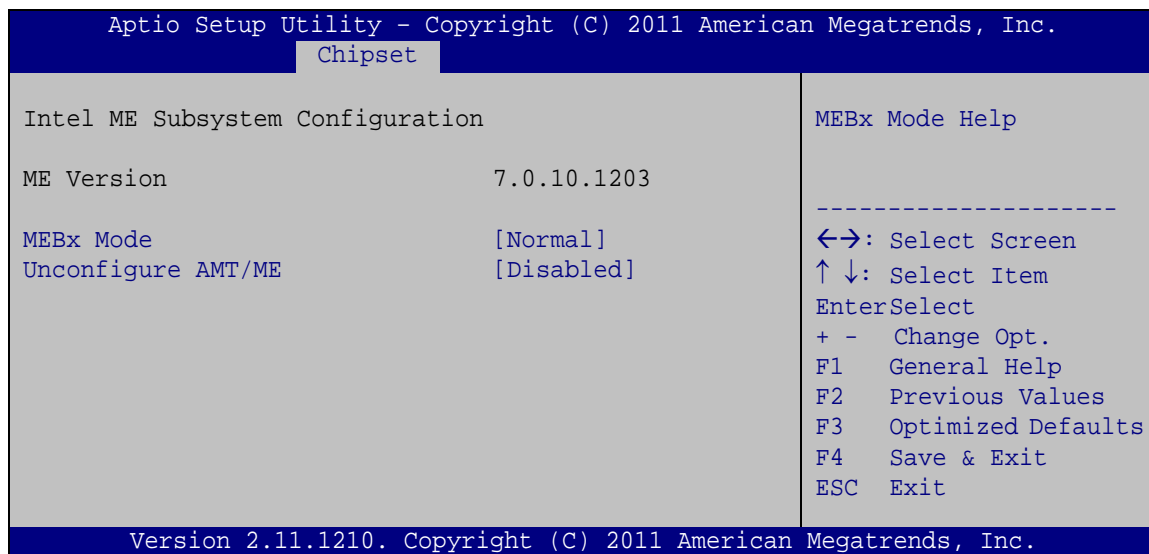
### → IGD - Boot Type [VBIOS Default]

Use the **IGD - Boot Type** option to select the display device used by the system when it boots. For dual display support, select “Auto.” Configuration options are listed below.

- VBIOS Default **DEFAULT**
- CRT
- DVI-D
- HDMI

## 5.5.4 ME Subsystem

Use the **ME Subsystem** menu (**BIOS Menu 22**) to configure the Intel® Management Engine (ME) configuration options.



### BIOS Menu 22: ME Subsystem

### → MEBx Mode [Normal]

Use the **MEBx Mode** option to configure MEBx Mode options.

- **Normal** **DEFAULT** Enables normal mode



- ➔ **Hidden Ctrl + P** Enables hidden Ctrl+P function
- ➔ **Enter MEBx Setup** Enables user to enter MEBx setup

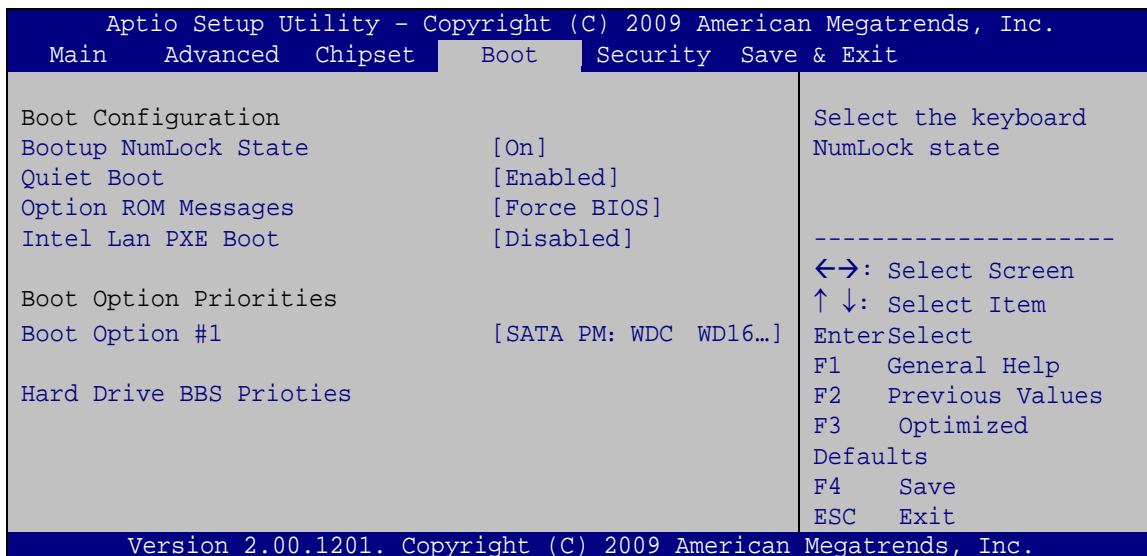
- ➔ Unconfigure AMT/ME [Enabled]

Use the **Unconfigure AMT/ME** option to perform AMT/ME unconfigure without password operation.

- ➔ **Disabled** Disable AMT/ME unconfigure
- ➔ **Enabled** **DEFAULT** Enable AMT/ME unconfigure

## 5.6 Boot

Use the **Boot** menu (**BIOS Menu 23**) to configure system boot options.



### BIOS Menu 23: Boot

- ➔ Bootup NumLock State [On]

Use the **Bootup NumLock State** BIOS option to specify if the number lock setting must be modified during boot up.

## ECN-780-Q67 Embedded System

- ➔ **Off** Does not enable the keyboard Number Lock automatically. To use the 10-keys on the keyboard, press the Number Lock key located on the upper left-hand corner of the 10-key pad. The Number Lock LED on the keyboard lights up when the Number Lock is engaged.
- ➔ **On DEFAULT** Allows the Number Lock on the keyboard to be enabled automatically when the computer system boots up. This allows the immediate use of the 10-key numeric keypad located on the right side of the keyboard. To confirm this, the Number Lock LED light on the keyboard is lit.

### ➔ Quiet Boot [Enabled]

Use the **Quiet Boot** BIOS option to select the screen display when the system boots.

- ➔ **Disabled** Normal POST messages displayed
- ➔ **Enabled DEFAULT** OEM Logo displayed instead of POST messages

### ➔ Option ROM Messages [Force BIOS]

Use the **Option ROM Messages** option to allow add-on ROM (read-only memory) messages to be displayed.

- ➔ **Force BIOS DEFAULT** The system forces third party BIOS to display during system boot.
- ➔ **Keep Current** The system displays normal information during system boot.

### ➔ Intel LAN PXE Boot [Disabled]

Use the **Intel LAN PXE Boot** option to enable or disable the boot option for the Intel LAN PXE.

- ➔ **Disabled DEFAULT** Disables Intel LAN PXE Boot option
- ➔ **Enabled** Enables Intel LAN PXE Boot option

➔ **Boot Option Priorities**

Use the **Boot Option Priorities** function to set the system boot sequence from the available devices. The drive sequence also depends on the boot sequence in the individual device section.

➔ **Hard Drive BBS Priorities**

Use **Hard Drive BBS Priorities** option to set the system boot order.

## 5.7 Security

Use the **Security** menu (**BIOS Menu 24**) to set system and user passwords.

```

Aptio Setup Utility - Copyright (C) 2009 American Megatrends, Inc.
Main    Advanced  Chipset    Boot    Security  Save & Exit
-----
Password Description
If ONLY the Administrator's password is set,
then this only limits access to Setup and is
only asked for when entering Setup
If ONLY the User's password is set, then this
is a power on password and must be entered to
boot or enter Setup. In Setup the User will
have Administrator rights.

Administrator Password
User Password

Set Setup Administrator
Password

-----
<->: Select Screen
↑ ↓: Select Item
EnterSelect
F1   General Help
F2   Previous Values
F3   Optimized
Defaults
F4   Save
ESC  Exit

Version 2.00.1201. Copyright (C) 2009 American Megatrends, Inc.
    
```

### BIOS Menu 24: Security

➔ **Administrator Password**

Use the **Administrator Password** to set or change a administrator password.

➔ **User Password**

Use the **User Password** to set or change a user password.

## 5.8 Exit

Use the **Exit** menu (**BIOS Menu 25**) to load default BIOS values, optimal failsafe values and to save configuration changes.

```

Aptio Setup Utility - Copyright (C) 2009 American Megatrends, Inc.
Main   Advanced  Chipset   Boot     Security  Save & Exit
-----
Save Changes and Exit
Discard Changes and Exit

Restore Defaults
Save as User Defaults
Restore User Defaults

Restore/Load Default
values for all the setup
options.

-----
<->: Select Screen
↑ ↓: Select Item
Enter>Select
F1   General Help
F2   Previous Values
F3   Optimized
Defaults
F4   Save
ESC  Exit

Version 2.00.1201. Copyright (C) 2009 American Megatrends, Inc.

```

### BIOS Menu 25:Exit

#### ➔ Save Changes and Exit

Use the **Save Changes and Reset** option to save the changes made to the BIOS options and to exit the BIOS configuration setup program.

#### ➔ Discard Changes and Exit

Use the **Discard Changes and Reset** option to exit the system without saving the changes made to the BIOS configuration setup program.

#### ➔ Restore Defaults

Use the **Restore Defaults** option to load the optimal default values for each of the parameters on the Setup menus. **F3 key can be used for this operation.**



➔ Save as User Defaults

Use the **Save as User Defaults** option to save the changes done so far as user defaults.

➔ Restore User Defaults

Use the **Restore User Defaults** option to restore the user defaults to all the setup options.

Chapter

5

# Software Drivers

---

## 6.1 Available Software Drivers

---



### NOTE:

The content of the CD may vary throughout the life cycle of the product and is subject to change without prior notice. Visit the IEI website or contact technical support for the latest updates.

---

The following drivers can be installed on the system:

- Chipset
- VGA
- LAN
- Audio
- USB 3.0
- SA46\_ME\_SW\_IS

Installation instructions are given below.

## 6.2 Starting the Driver Program

To access the driver installation programs, please do the following.

**Step 1:** Insert the CD-ROM that came with the system into a CD-ROM drive attached to the system.

**Step 2:** Click **ECN-780-Q67 Driver**.

**Step 3:** A list of available drivers appears.



Figure 6-1: Drivers

### 6.3 Chipset Driver Installation

To install the chipset driver, please do the following.

- Step 1: Access the driver list. (See **Section 6.2**)
- Step 2: Click “**Chipset.**”
- Step 3: Locate the setup file and double click on it.
- Step 4: The setup files are extracted as shown in **Figure 6-2.**



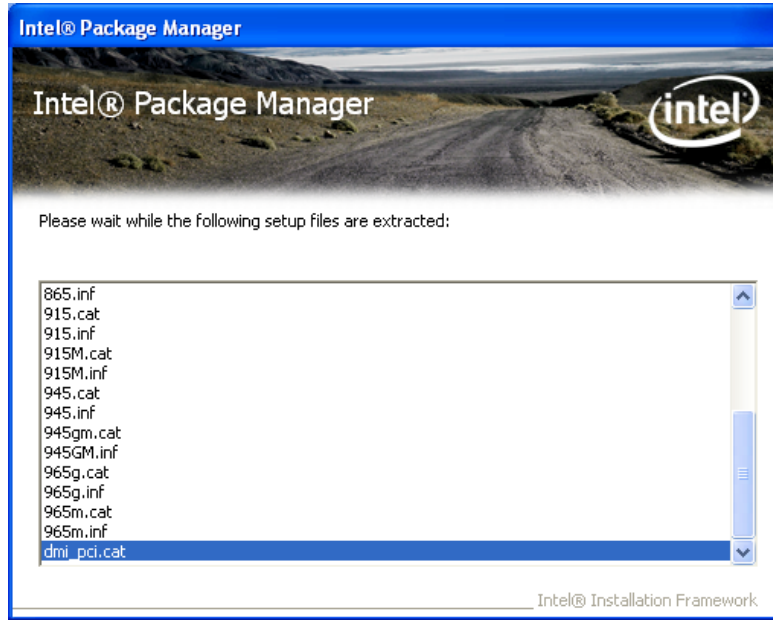


Figure 6-2: Chipset Driver Screen

Step 5: When the setup files are completely extracted the **Welcome Screen** in **Figure 6-3** appears.

Step 6: Click **Next** to continue.



Figure 6-3: Chipset Driver Welcome Screen

Step 7: The license agreement in **Figure 6-4** appears.

## ECN-780-Q67 Embedded System

Step 8: Read the **License Agreement**.

Step 9: Click **Yes** to continue.



Figure 6-4: Chipset Driver License Agreement

Step 10: The **Read Me** file in **Figure 6-5** appears.

Step 11: Click **Next** to continue.

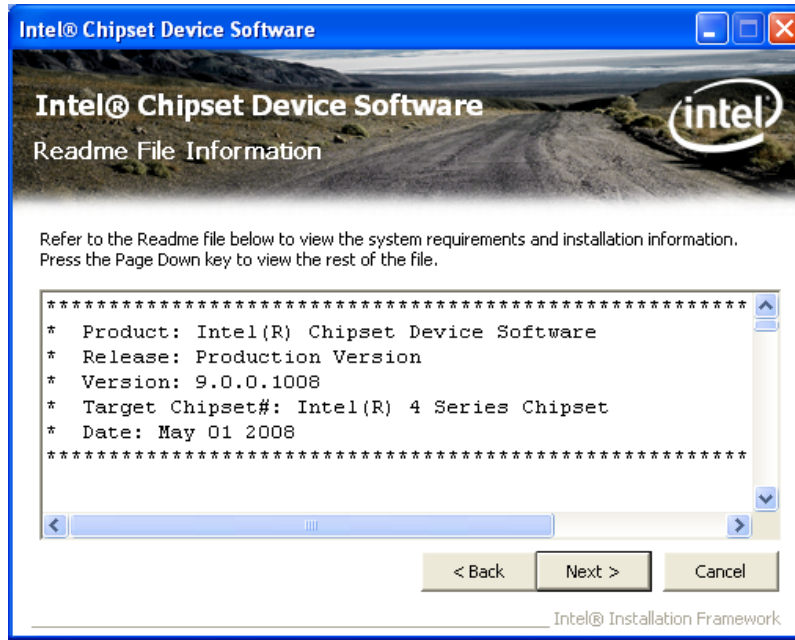


Figure 6-5: Chipset Driver Read Me File

Step 12: **Setup Operations** are performed as shown in Figure 6-6.

Step 13: Once the **Setup Operations** are complete, click **Next** to continue.

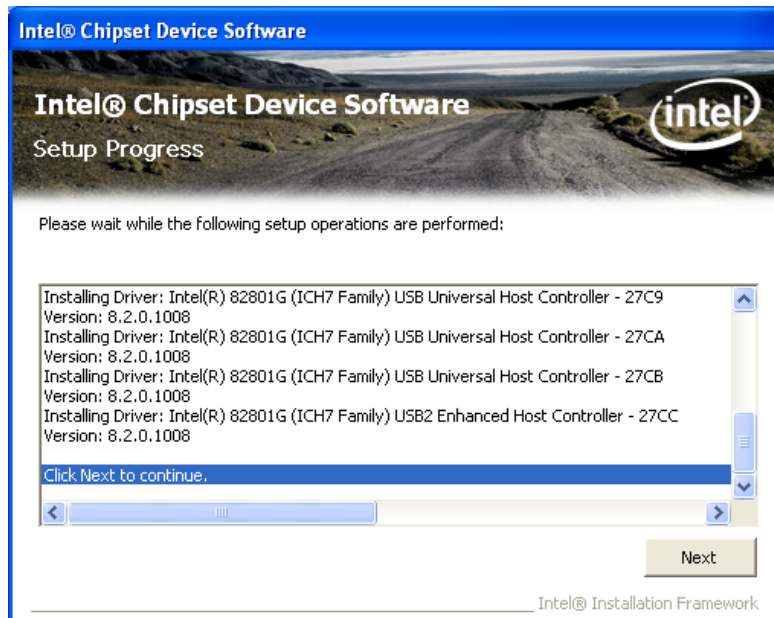


Figure 6-6: Chipset Driver Setup Operations

Step 14: The **Finish** screen in Figure 6-7 appears.



**Step 15:** Select “**Yes, I want to restart this computer now**” and click **Finish**.



**Figure 6-7: Chipset Driver Installation Finish Screen**

## 6.4 Graphics Driver Installation

To install the Graphics driver, please do the following.

**Step 1:** Access the driver list. (See **Section 6.2**)

**Step 2:** Click “**VGA**” and select the folder which corresponds to your operating system.

**Step 3:** Double click the setup file.

**Step 4:** The **Read Me** file in **Figure 6-8** appears.

**Step 5:** Click **Next** to continue.



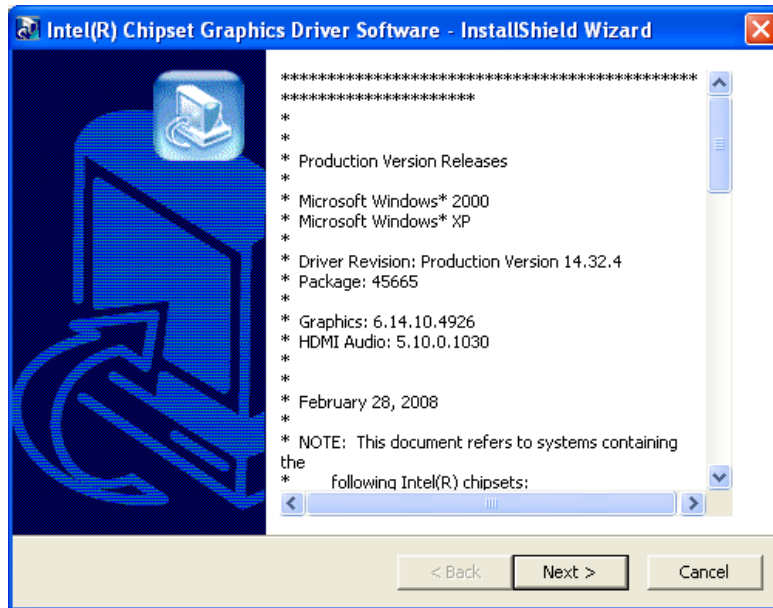


Figure 6-8: Graphics Driver Read Me File

Step 6: The installation files are extracted. See Figure 6-9.

Step 7: Click **Next** to continue.

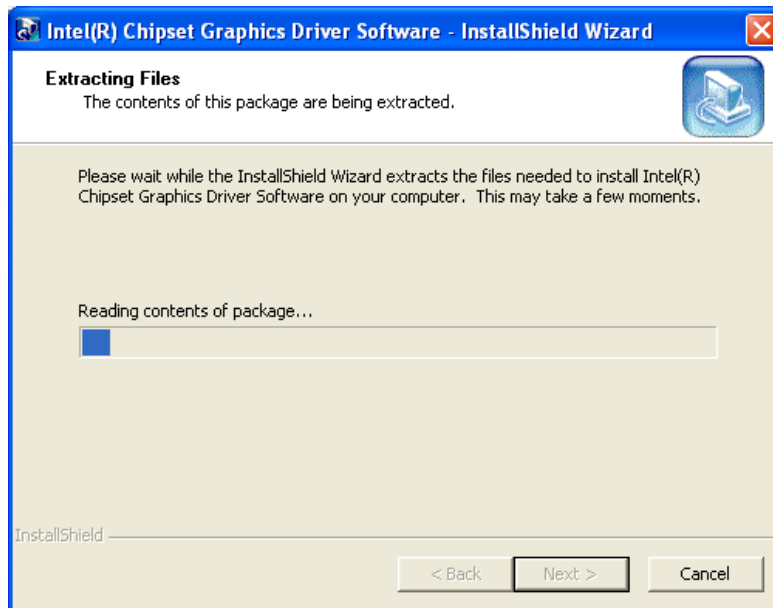
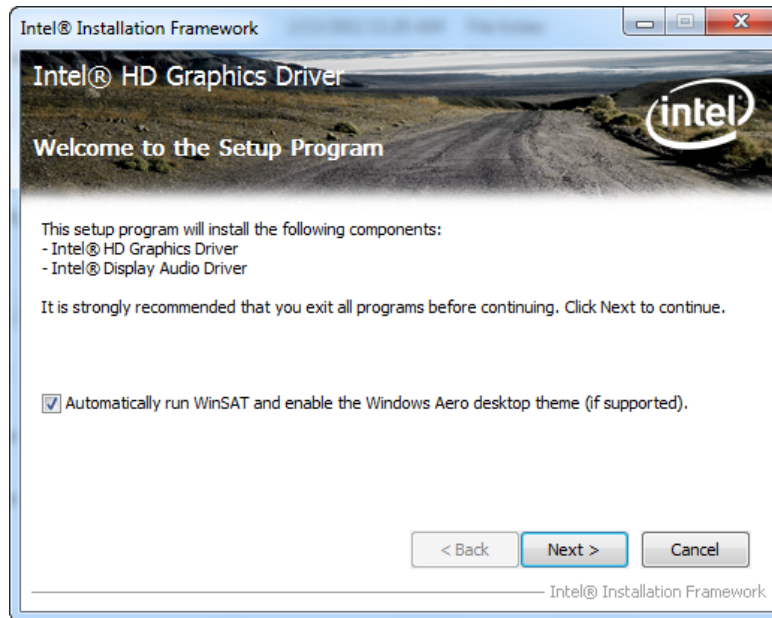


Figure 6-9: Graphics Driver Setup Files Extracted

Step 8: The **Welcome Screen** in Figure 6-10 appears.

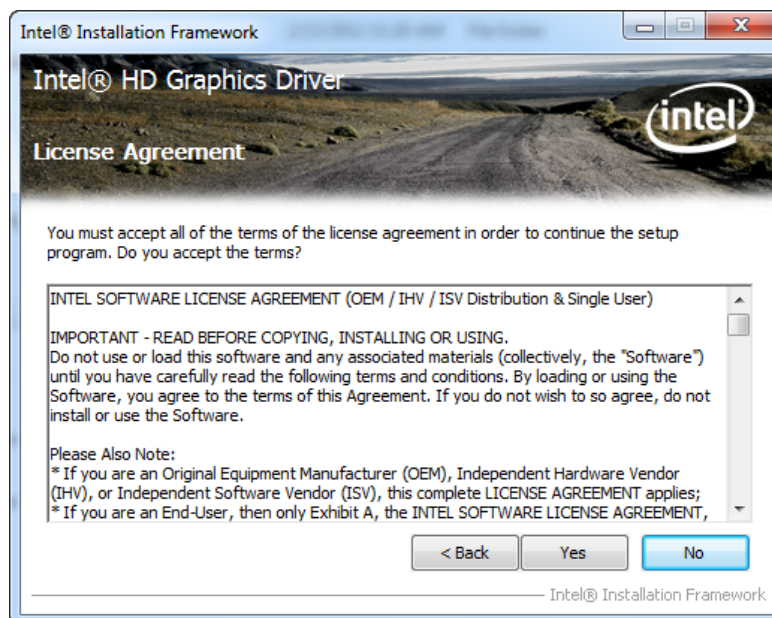
Step 9: Click **Next** to continue.



**Figure 6-10: Graphics Driver Welcome Screen**

**Step 10:** The **License Agreement** in **Figure 6-11** appears.

**Step 11:** Click **Yes** to accept the agreement and continue.



**Figure 6-11: Graphics Driver License Agreement**

**Step 12:** The **Read Me** file in **Figure 6-12** appears.

**Step 13:** Click **Next** to continue.

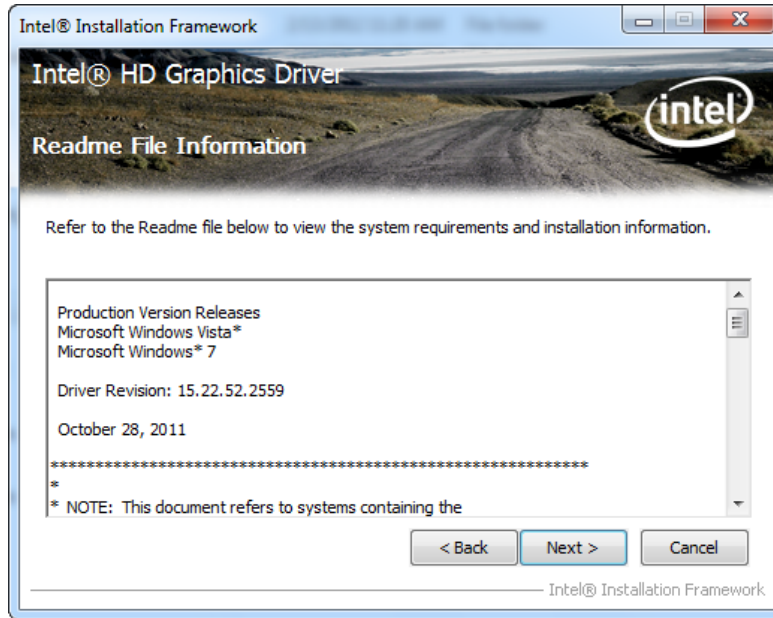


Figure 6-12: Graphics Driver Read Me File

Step 14: **Setup Operations** are performed as shown in Figure 6-13.

Step 15: Once the **Setup Operations** are complete, click **Next** to continue.

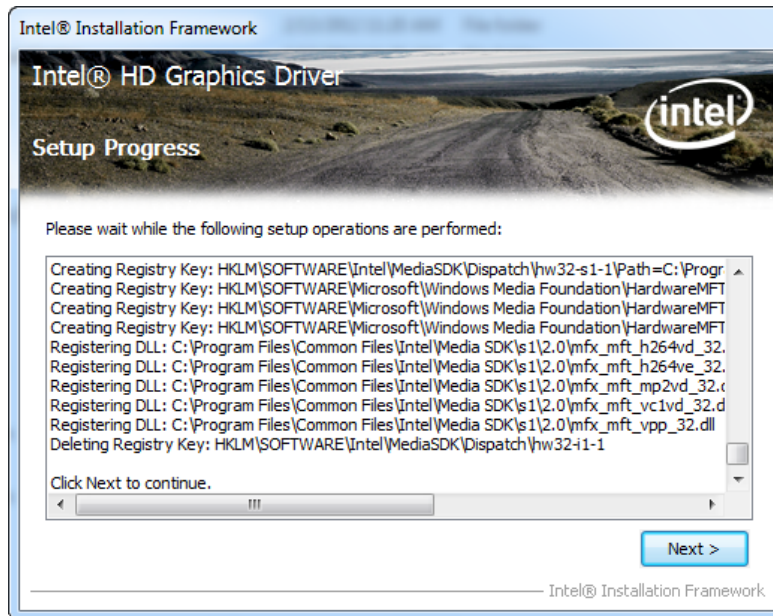
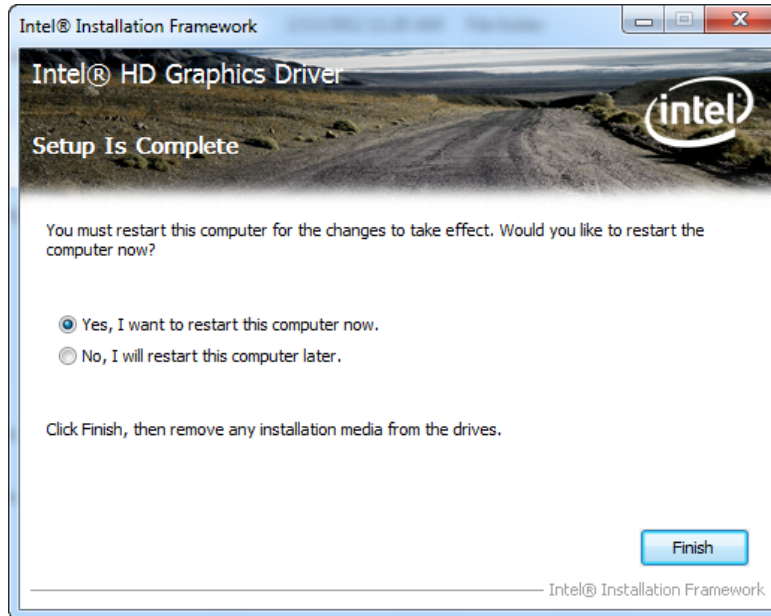


Figure 6-13: Graphics Driver Setup Operations

Step 16: The **Finish Screen** in Figure 6-14 appears.

Step 17: Select **"Yes, I want to restart this computer now"** and click **Finish**.





**Figure 6-14: Graphics Driver Installation Finish Screen**

## 6.5 LAN Driver Installation

To install the LAN driver, please do the following.

**Step 1:** Access the driver list. (See **Section 6.2**)

**Step 2:** Click **“LAN”**.

**Step 3:** Locate the Autorun file and double click it.

**Step 4:** The Intel® Network Connection menu in **Figure 6-15** appears.

**Step 5:** Click **Install Drivers and Software**.



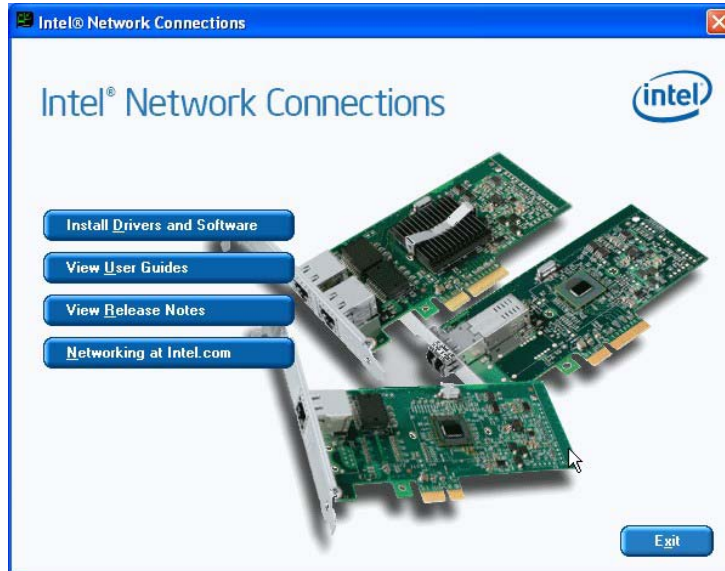


Figure 6-15: Intel® Network Connection Menu

Step 6: The **Welcome** screen in Figure 6-16 appears.



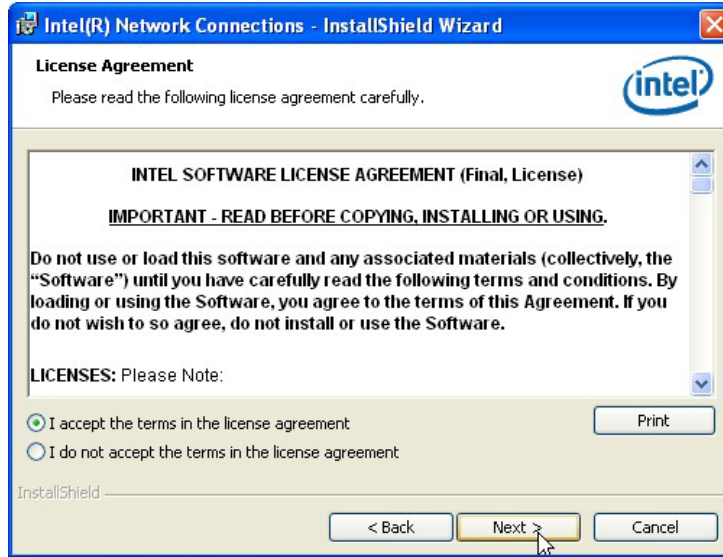
Figure 6-16: LAN Driver Welcome Screen

Step 7: Click **Next** to continue.

Step 8: The **License Agreement** in Figure 6-17 appears.

Step 9: Accept the agreement by selecting “**I accept the terms in the license agreement**”.

Step 10: Click **Next** to continue.

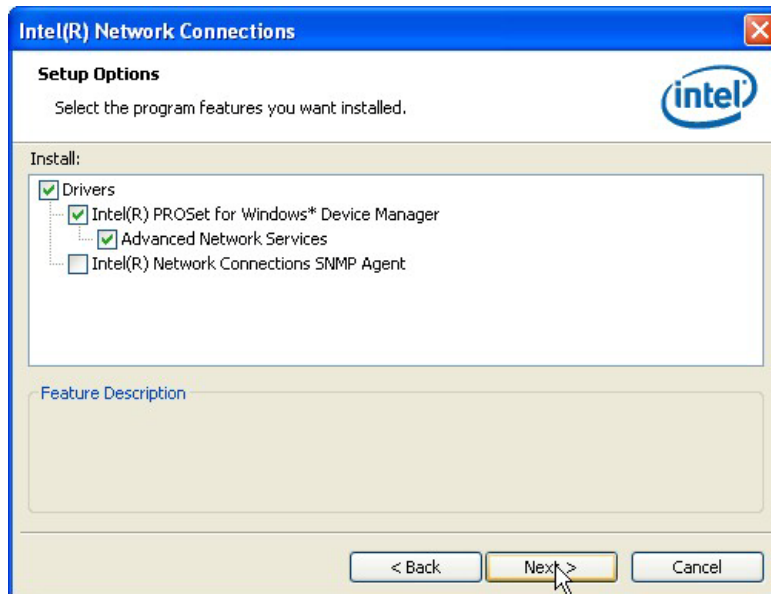


**Figure 6-17: LAN Driver License Agreement**

Step 11: The **Setup Options** screen in **Figure 6-18** appears.

Step 12: Select program features to install.

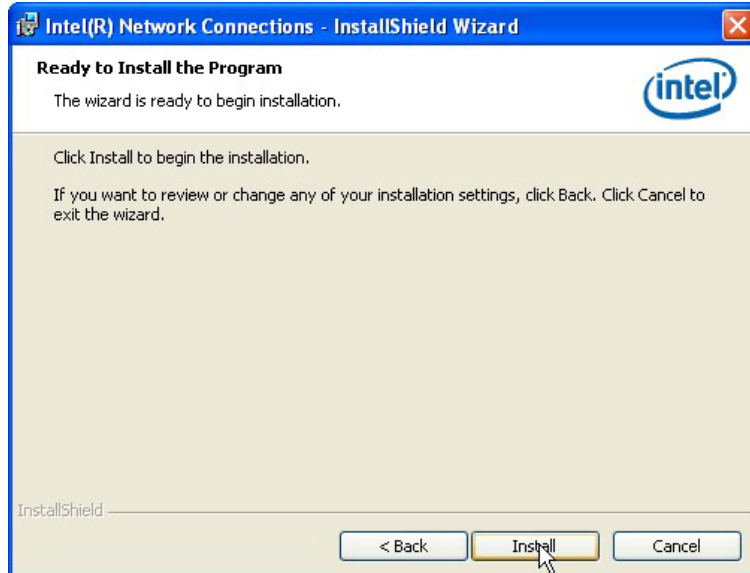
Step 13: Click **Next** to continue.



**Figure 6-18: LAN Driver Setup Options**

**Step 14:** The **Ready to Install the Program** screen in **Figure 6-19** appears.

**Step 15:** Click **Install** to proceed with the installation.

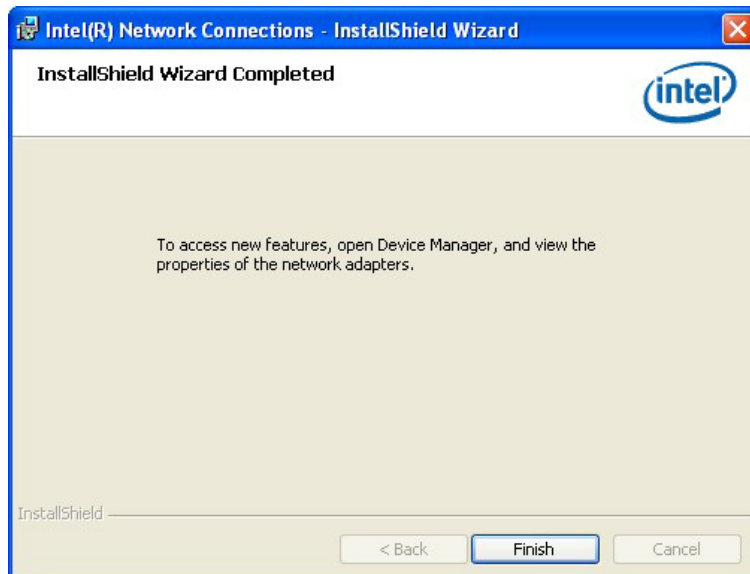


**Figure 6-19: LAN Driver Installation**

**Step 16:** The program begins to install.

**Step 17:** When the driver installation is complete, the screen in **Figure 6-20** appears.

**Step 18:** Click **Finish** to exit.



**Figure 6-20: LAN Driver Installation Complete**



## 6.6 Audio Driver Installation

To install the audio driver, please do the following.

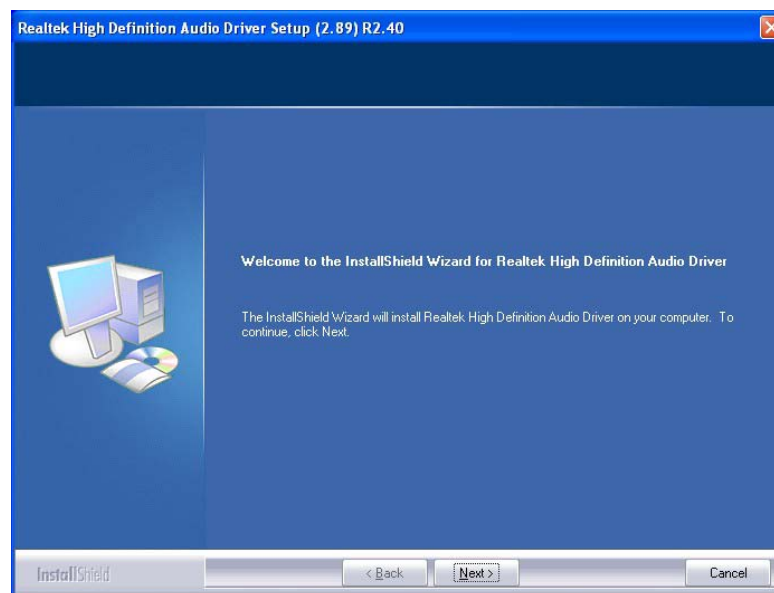
**Step 1:** Access the driver list. (See **Section 6.2**)

**Step 2:** Click **“Audio”** and select the folder which corresponds to your operating system.

**Step 3:** Double click the setup file.

**Step 4:** The **Audio Driver Welcome Screen** in **Figure 6-21** appears.

**Step 5:** Click **Next** to continue.



**Figure 6-21: Audio Driver Welcome Screen**

**Step 6:** The audio driver installation begins. See **Figure 6-22**.



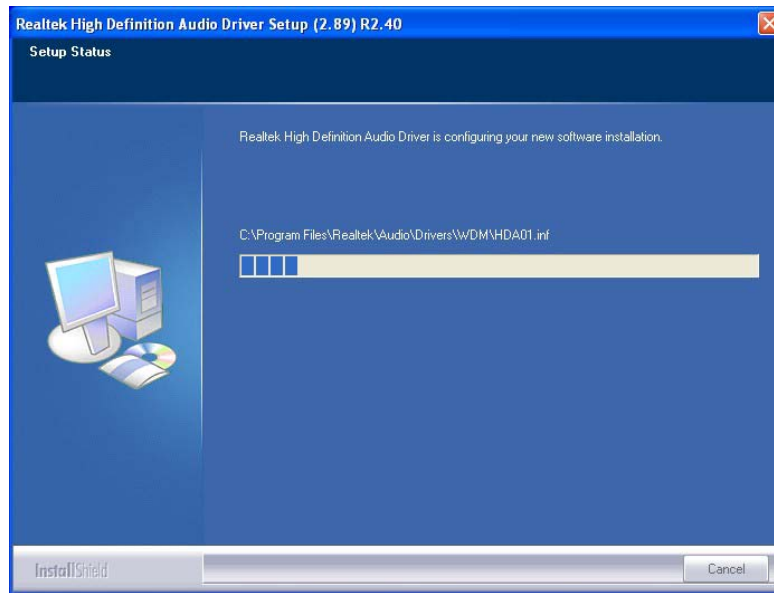


Figure 6-22: Audio Driver Installation

Step 7: When the installation is complete, the screen in **Figure 6-23** appears.

Step 8: Select “**Yes, I want to restart my computer now**” and click **Finish**.

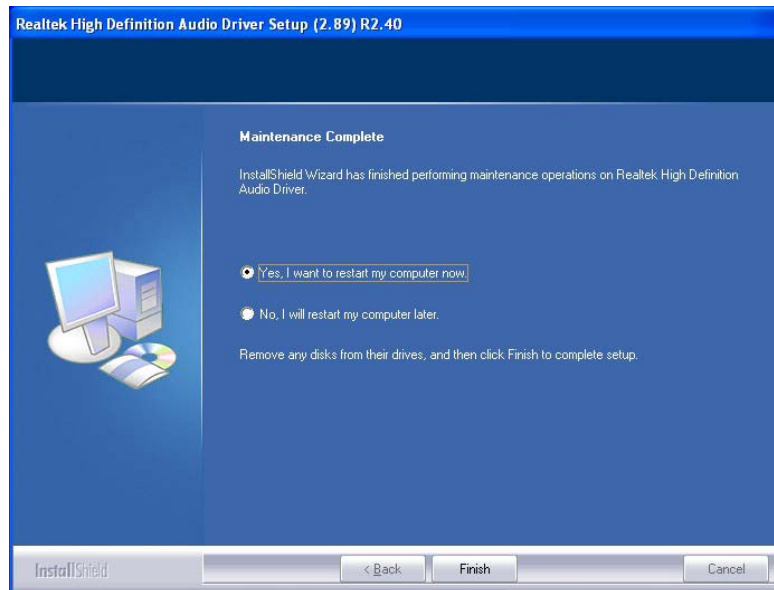
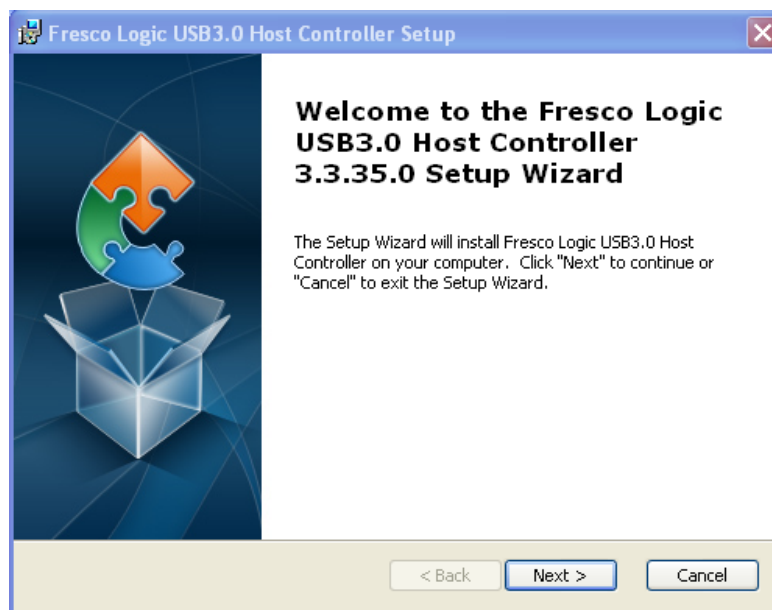


Figure 6-23: Audio Driver Installation Complete

## 6.7 USB 3.0 Driver Installation

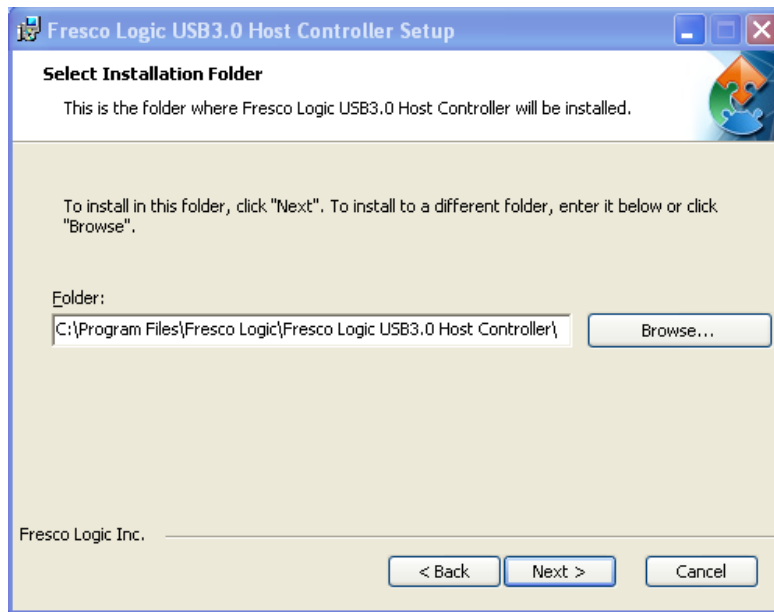
To install the USB 3.0 driver, please do the following.

- Step 1:** Access the driver list. (See **Section 6.2**)
- Step 2:** Click **"USB 3.0"** and select the folder which corresponds to your operating system.
- Step 3:** Double click the setup file.
- Step 4:** The **Welcome Screen** in **Figure 6-24** appears.
- Step 5:** Click **Next** to continue.



**Figure 6-24: USB 3.0 Driver Welcome Screen**

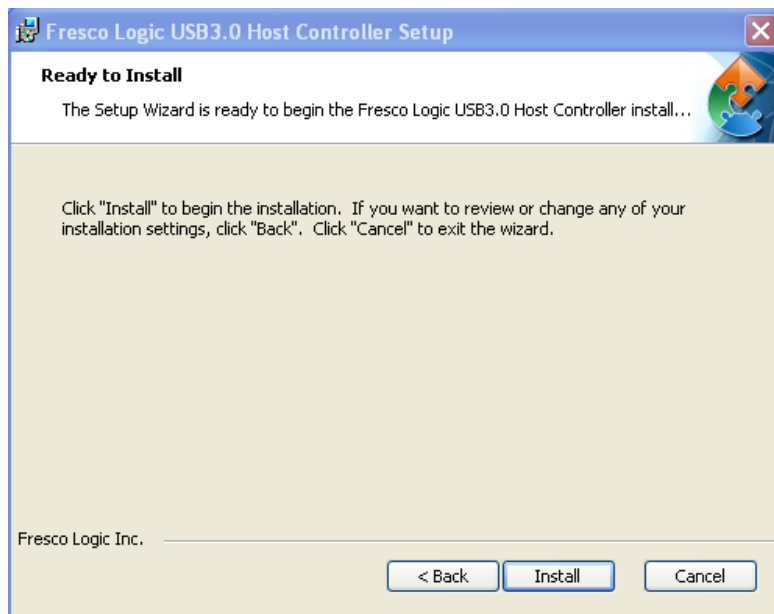
- Step 6:** Browse for an inst1all location or use the one suggested (**Figure 6-25**).
- Step 7:** Click **NEXT** to continue.



**Figure 6-25: USB 3.0 Driver Choose Install Location**

**Step 8:** The program is ready to install (**Figure 6-26**).

**Step 9:** Click **INSTALL** to continue.



**Figure 6-26: USB 3.0 Driver Choose Install Location**

**Step 10:** When the driver installation is complete, the screen in **Figure 6-27** appears.

**Step 11:** Click **Finish** to exit.



**Figure 6-27: USB 3.0 Driver Installation Complete**

## 6.8 Intel® Management Engine Components Installation

The package of the Intel® ME components includes

- Intel® Management Engine Interface (Intel® ME Interface)
- Serial Over LAN (SOL) driver
- Local Manageability Service (LMS)
- User Notification Service (UNS)
- Intel® Management and Security Status Application

To install these Intel® ME components, please do the following.

**Step 1:** Access the driver list. (See **Section 6.2**)

**Step 2:** Click "**SA46\_ME\_SW\_IS**".

**Step 3:** Locate the setup file and double click it.

**Step 4:** When the setup files are completely extracted the **Welcome Screen** in **Figure**



6-28 appears.

Step 5: Click **Next** to continue.

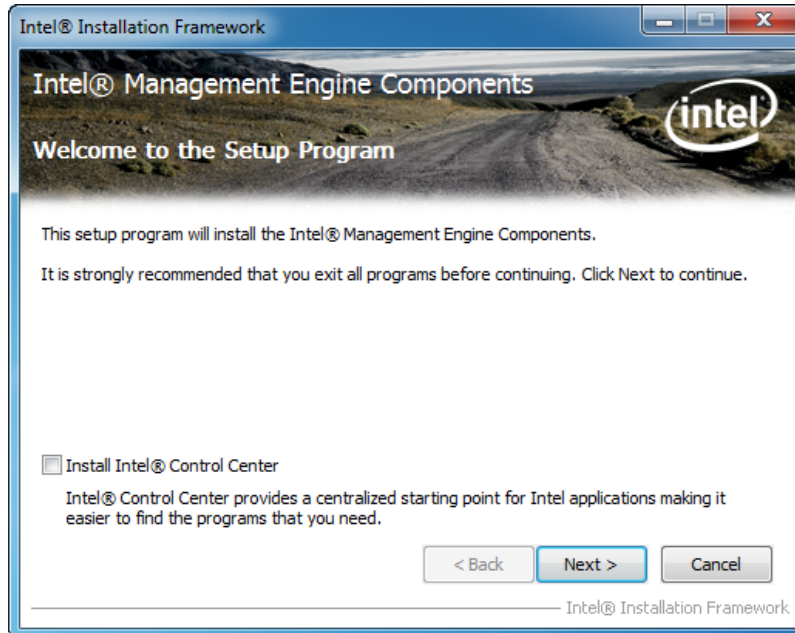


Figure 6-28: Intel® ME Driver Welcome Screen

Step 6: The license agreement in **Figure 6-29** appears.

Step 7: Read the **License Agreement**.

Step 8: Click **Yes** to continue.



Figure 6-29: Intel® ME Driver License Agreement

Step 9: The Read Me file in Figure 6-30 appears.

Step 10: Click **Next** to continue.

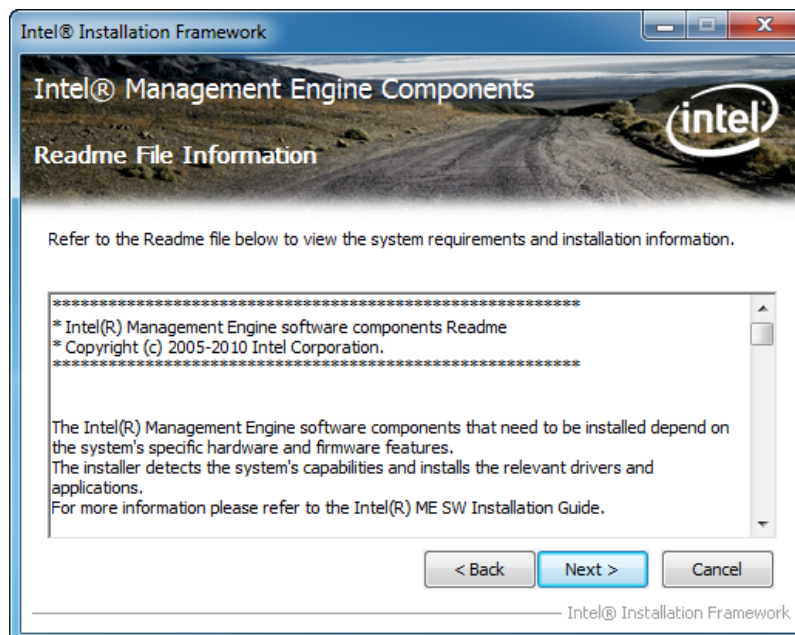
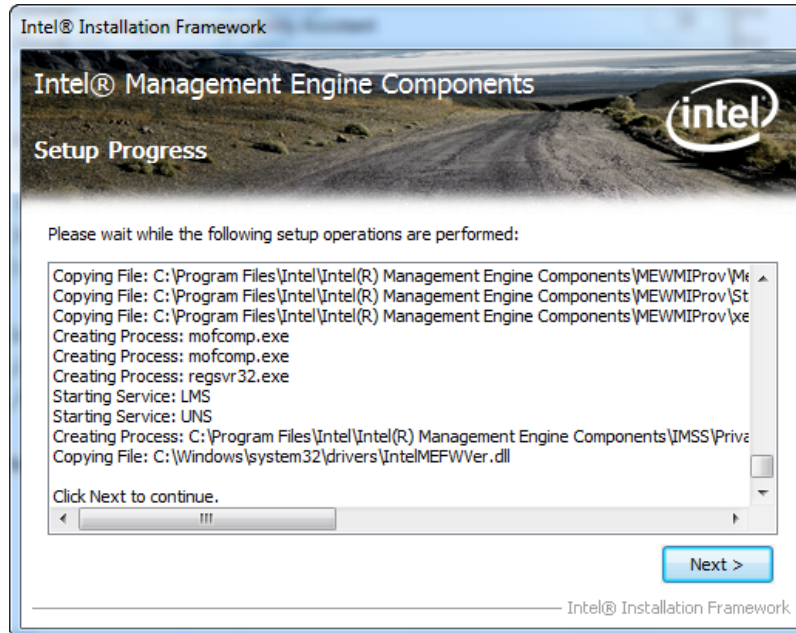


Figure 6-30: Intel® ME Driver Read Me File

**Step 11:** **Setup Operations** are performed as shown in **Figure 6-31**.

**Step 12:** Once the **Setup Operations** are complete, click **Next** to continue.



**Figure 6-31: Intel® ME Driver Setup Operations**

**Step 13:** The **Finish** screen in **Figure 6-32** appears.

**Step 14:** Select **“Yes, I want to restart this computer now”** and click **Finish**.



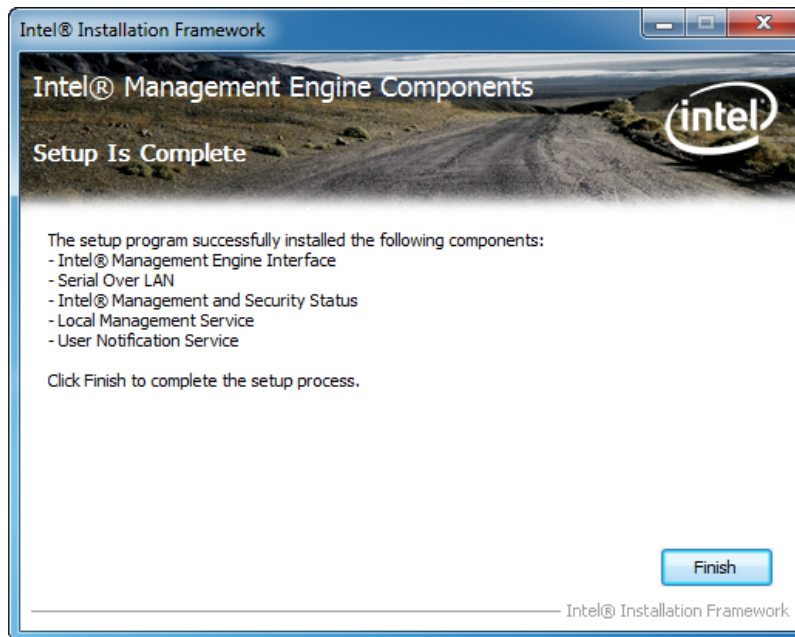


Figure 6-32: Intel® ME Driver Installation Finish Screen



Appendix

A

# Safety Precautions

---

**WARNING:**

The precautions outlined in this chapter should be strictly followed. Failure to follow these precautions may result in permanent damage to the ECN-780-Q67.

## A.1 Safety Precautions

Please follow the safety precautions outlined in the sections that follow:

### A.1.1 General Safety Precautions

Please ensure the following safety precautions are adhered to at all times.

- **Follow the electrostatic precautions** outlined below whenever the ECN-780-Q67 is opened.
- **Make sure the power is turned off and the power cord is disconnected** whenever the ECN-780-Q67 is being installed, moved or modified.
- **Do not apply voltage levels that exceed the specified voltage range.** Doing so may cause fire and/or an electrical shock.
- **Electric shocks can occur** if the ECN-780-Q67 chassis is opened when the ECN-780-Q67 is running.
- **Do not drop or insert any objects** into the ventilation openings of the ECN-780-Q67.
- **If considerable amounts of dust, water, or fluids enter the ECN-780-Q67,** turn off the power supply immediately, unplug the power cord, and contact the ECN-780-Q67 vendor.
- **DO NOT:**
  - Drop the ECN-780-Q67 against a hard surface.
  - In a site where the ambient temperature exceeds the rated temperature

### A.1.2 Anti-static Precautions

---



#### WARNING:

Failure to take ESD precautions during the installation of the ECN-780-Q67 may result in permanent damage to the ECN-780-Q67 and severe injury to the user.

---

Electrostatic discharge (ESD) can cause serious damage to electronic components, including the ECN-780-Q67. Dry climates are especially susceptible to ESD. It is therefore critical that whenever the ECN-780-Q67 is opened and any of the electrical components are handled, the following anti-static precautions are strictly adhered to.

- ***Wear an anti-static wristband:*** Wearing a simple anti-static wristband can help to prevent ESD from damaging any electrical component.
- ***Self-grounding:*** Before handling any electrical component, touch any grounded conducting material. During the time the electrical component is handled, frequently touch any conducting materials that are connected to the ground.
- ***Use an anti-static pad:*** When configuring or working with an electrical component, place it on an anti-static pad. This reduces the possibility of ESD damage.
- ***Only handle the edges of the electrical component:*** When handling the electrical component, hold the electrical component by its edges.

### A.1.3 Product Disposal

---

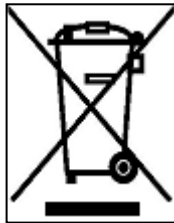
**CAUTION:**

Risk of explosion if battery is replaced by and incorrect type. Only certified engineers should replace the on-board battery.

Dispose of used batteries according to instructions and local regulations.

---

- Outside the European Union - If you wish to dispose of used electrical and electronic products outside the European Union, please contact your local authority so as to comply with the correct disposal method.
- Within the European Union:



EU-wide legislation, as implemented in each Member State, requires that waste electrical and electronic products carrying the mark (left) must be disposed of separately from normal household waste. This includes monitors and electrical accessories, such as signal cables or power cords.

When you need to dispose of your display products, please follow the guidance of your local authority, or ask the shop where you purchased the product. The mark on electrical and electronic products only applies to the current European Union Member States.

Please follow the national guidelines for electrical and electronic product disposal.

## A.2 Maintenance and Cleaning Precautions

When maintaining or cleaning the ECN-780-Q67, please follow the guidelines below.

### A.2.1 Maintenance and Cleaning

Prior to cleaning any part or component of the ECN-780-Q67, please read the details below.



- The interior of the ECN-780-Q67X does not require cleaning. Keep fluids away from the ECN-780-Q67 interior.
- Be cautious of all small removable components when vacuuming the ECN-780-Q67.
- Turn the ECN-780-Q67 off before cleaning the ECN-780-Q67.
- Never drop any objects or liquids through the openings of the ECN-780-Q67.
- Be cautious of any possible allergic reactions to solvents or chemicals used when cleaning the ECN-780-Q67.
- Avoid eating, drinking and smoking within vicinity of the ECN-780-Q67.

### A.2.2 Cleaning Tools

Some components in the ECN-780-Q67 may only be cleaned using a product specifically designed for the purpose. In such case, the product will be explicitly mentioned in the cleaning tips. Below is a list of items to use when cleaning the ECN-780-Q67.

- **Cloth** – Although paper towels or tissues can be used, a soft, clean piece of cloth is recommended when cleaning the ECN-780-Q67.
- **Water or rubbing alcohol** – A cloth moistened with water or rubbing alcohol can be used to clean the ECN-780-Q67.
- **Using solvents** – The use of solvents is not recommended when cleaning the ECN-780-Q67 as they may damage the plastic parts.
- **Vacuum cleaner** – Using a vacuum specifically designed for computers is one of the best methods of cleaning the ECN-780-Q67. Dust and dirt can restrict the airflow in the ECN-780-Q67 and cause its circuitry to corrode.
- **Cotton swabs** - Cotton swabs moistened with rubbing alcohol or water are excellent tools for wiping hard to reach areas.
- **Foam swabs** - Whenever possible, it is best to use lint free swabs such as foam swabs for cleaning.

Appendix

**B**

# BIOS Menu Options

---

➔ BIOS Information .....	59
➔ iWDD Vendor .....	59
➔ iWDD Version .....	60
➔ Memory Information .....	60
➔ System Date [xx/xx/xx] .....	60
➔ System Time [xx:xx:xx] .....	60
➔ ACPI Sleep State [S1 (CPU Stop Clock)] .....	62
➔ Wake system with Fixed Time [Disabled].....	62
➔ TPM Support [Disable] .....	64
➔ Hyper-threading [Enabled].....	64
➔ Intel Virtualization Technology [Enabled] .....	65
➔ SATA Mode [IDE Mode] .....	66
➔ Serial-ATA Controller 0 [Compatible] .....	67
➔ USB Devices .....	68
➔ Legacy USB Support [Enabled].....	68
➔ Serial Port [Enabled].....	70
➔ Change Settings [Auto] .....	70
➔ Serial Port [Enabled].....	71
➔ Change Settings [Auto] .....	71
➔ Serial Port [Enabled].....	72
➔ Change Settings [Auto] .....	72
➔ Serial Port [Enabled].....	73
➔ Change Settings [Auto] .....	73
➔ Serial Port [Enabled].....	73
➔ Change Settings [Auto] .....	74
➔ Device Mode [RS422/485].....	74
➔ PC Health Status .....	75
➔ CPU Smart Fan control [Auto PWM Mode].....	76
➔ Temperature of Start [75] .....	77
➔ Temperature of Off [80] .....	77
➔ Start PWM [30].....	77
➔ Slope (Duty Cycle) [4].....	78
➔ Console Redirection .....	79
➔ Terminal Type [ANSI].....	80

➔	Bits per second [115200].....	80
➔	Auto Recovery Function [Disabled].....	81
➔	VT-d [Disabled].....	83
➔	IGD Memory [128M] .....	83
➔	Restore AC Power Loss [Last State] .....	84
➔	Azalia HD Audio [Enabled].....	85
➔	Azalia internal HDMI codec [Enabled] .....	85
➔	Power Saving Function [Disabled].....	85
➔	WIFI Function [Enabled].....	85
➔	DVMT Mode Select [DVMT Mode].....	86
➔	DVMT Memory [Maximum].....	86
➔	IGD - Boot Type [VBIOS Default] .....	87
➔	MEBx Mode [Normal].....	87
➔	Unconfigure AMT/ME [Enabled] .....	88
➔	Bootup NumLock State [On].....	88
➔	Quiet Boot [Enabled] .....	89
➔	Option ROM Messages [Force BIOS].....	89
➔	Intel LAN PXE Boot [Disabled] .....	89
➔	Boot Option Priorities.....	90
➔	Hard Drive BBS Priorities.....	90
➔	Administrator Password .....	90
➔	User Password .....	90
➔	Save Changes and Exit .....	91
➔	Discard Changes and Exit.....	91
➔	Restore Defaults .....	91
➔	Save as User Defaults .....	92
➔	Restore User Defaults .....	92





Appendix

C

# One Key Recovery

---

## C.1 One Key Recovery Introduction

The IEI one key recovery is an easy-to-use front end for the Norton Ghost system backup and recovery tool. This tool provides quick and easy shortcuts for creating a backup and reverting to that backup or reverting to the factory default settings.



### NOTE:

The latest One Key Recovery software provides an auto recovery function that allows a system running Microsoft Windows OS to automatically restore from the factory default image after encountering a Blue Screen of Death (BSoD) or a hang for around 10 minutes. Please refer to Section C.3 for the detailed setup procedure.

The IEI One Key Recovery tool menu is shown below.

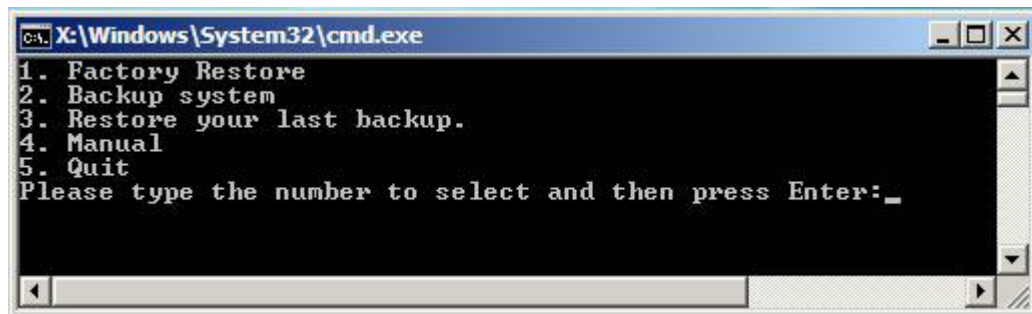


Figure C-1: IEI One Key Recovery Tool Menu

Prior to using the IEI One Key Recovery tool (as shown in **Figure C-1**) to backup or restore Windows system, five setup procedures are required.

1. Hardware and BIOS setup (see **Section C.2.1**)
2. Create partitions (see **Section C.2.2**)
3. Install operating system, drivers and system applications (see **Section C.2.3**)
4. Build the recovery partition (see **Section C.2.4**)
5. Create factory default image (see **Section C.2.5**)

After completing the five initial setup procedures as described above, users can access the recovery tool by pressing <F3> while booting up the system. The detailed information of each function is described in **Section C.5**.


**NOTE:**

The initial setup procedures for Linux system are described in **Section C.3**.

### C.1.1 System Requirement


**NOTE:**

The recovery CD can only be used with IEI products. The software will fail to run and a warning message will appear when used on non-IEI hardware.



To create the system backup, the main storage device must be split into two partitions (three partitions for Linux). The first partition will be for the operating system, while the second partition will be invisible to the operating system and contain the backup made by the one key recovery software.

The partition created for recovery images must be big enough to contain both the factory default image and the user backup image. The size must be calculated before creating the

## ECN-780-Q67 Embedded System

partitions. Please take the following table as a reference when calculating the size of the partition.

	OS	OS Image after Ghost	Compression Ratio
<b>Windows® 7</b>	7 GB	5 GB	70%
<b>Windows® XPE</b>	776 MB	560 MB	70%
<b>Windows® CE 6.0</b>	36 MB	28 MB	77%



### NOTE:

Specialized tools are required to change the partition size if the operating system is already installed.

### C.1.2 Supported Operating System

The recovery CD is compatible with both Microsoft Windows and Linux operating systems (OS). The supported OS versions are listed below.

- Microsoft Windows
  - Windows XP (Service Pack 2 or 3 required)
  - Windows Vista
  - Windows 7
  - Windows CE 5.0
  - Windows CE 6.0
  - Windows XP Embedded
- Linux
  - Fedora Core 12 (Constantine)
  - Fedora Core 11 (Leonidas)
  - Fedora Core 10 (Cambridge)
  - Fedora Core 8 (Werewolf)
  - Fedora Core 7 (Moonshine)
  - RedHat RHEL-5.4
  - RedHat 9 (Ghirke)



- Ubuntu 8.10 (Intrepid)
- Ubuntu 7.10 (Gutsy)
- Ubuntu 6.10 (Edgy)
- Debian 5.0 (Lenny)
- Debian 4.0 (Etch)
- SuSe 11.2
- SuSe 10.3

**NOTE:**

Installing unsupported OS versions may cause the recovery tool to fail.

---

## C.2 Setup Procedure for Windows

Prior to using the recovery tool to backup or restore, a few setup procedures are required.

**Step 1:** Hardware and BIOS setup (see **Section C.2.1**)

**Step 2:** Create partitions (see **Section C.2.2**)

**Step 3:** Install operating system, drivers and system applications (see **Section C.2.3**)

**Step 4:** Build the recovery partition (see **Section C.2.4**) or build the auto recovery partition (see **Section C.3**)

**Step 5:** Create factory default image (see **Section C.2.5**)

The detailed descriptions are described in the following sections.

---

**NOTE:**

The setup procedures described below are for Microsoft Windows operating system users. For Linux, most of the setup procedures are the same except for several steps described in **Section C.3**.

---

### C.2.1 Hardware and BIOS Setup

- Step 1:** Make sure the system is powered off and unplugged.
- Step 2:** Install a hard drive or SSD in the system. An unformatted and unpartitioned disk is recommended.
- Step 3:** Connect an optical disk drive to the system and insert the recovery CD.
- Step 4:** Turn on the system.
- Step 5:** Press the **<DELETE>** key as soon as the system is turned on to enter the BIOS.
- Step 6:** Select the connected optical disk drive as the 1<sup>st</sup> boot device. (**Boot → Boot Device Priority → 1<sup>st</sup> Boot Device**).
- Step 7:** Save changes and restart the computer. Continue to the next section for instructions on partitioning the internal storage.

### C.2.2 Create Partitions

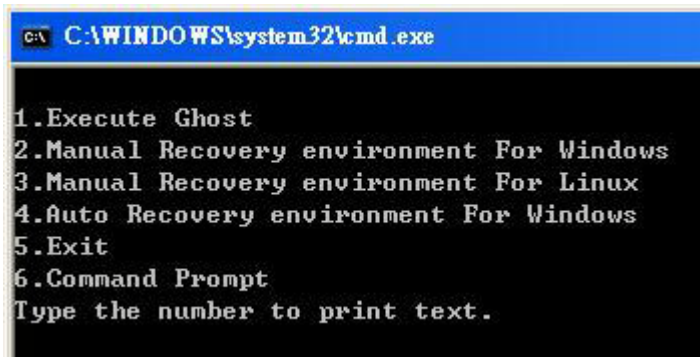
To create the system backup, the main storage device must be split into two partitions (three partitions for Linux). The first partition will be for the operating system, while the second partition will be invisible to the operating system and contain the backup made by the one key recovery software.

- Step 1:** Put the recovery CD in the optical drive of the system.
- Step 2:** **Boot the system from recovery CD.** When prompted, press any key to boot from the recovery CD. It will take a while to launch the recovery tool. Please be patient!



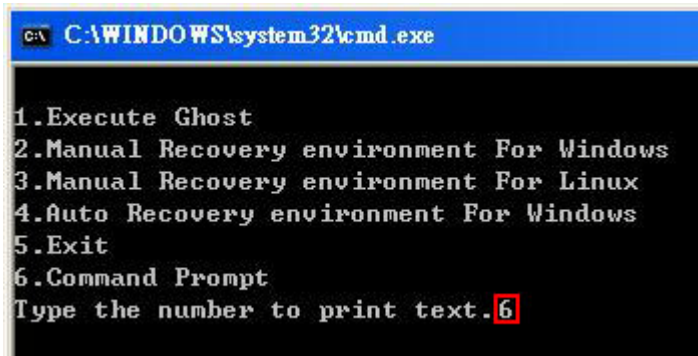
**Figure C-2: Launching the Recovery Tool**

**Step 3:** The recovery tool setup menu is shown as below.



**Figure C-3: Recovery Tool Setup Menu**

**Step 4:** Press <6> then <Enter>.



```
C:\WINDOWS\system32\cmd.exe

1.Execute Ghost
2.Manual Recovery environment For Windows
3.Manual Recovery environment For Linux
4.Auto Recovery environment For Windows
5.Exit
6.Command Prompt
Type the number to print text.6
```

Figure C-4: Command Prompt

**Step 5:** The command prompt window appears. Type the following commands (marked in red) to create two partitions. One is for the OS installation; the other is for saving recovery files and images which will be an invisible partition. (Press <Enter> after entering each line below)

```
system32>diskpart
DISKPART>list vol
DISKPART>sel disk 0
DISKPART>create part pri size= ____
DISKPART>assign letter=N
DISKPART>create part pri size= ____
DISKPART>assign letter=F
DISKPART>exit
system32>format N: /fs:ntfs /q /y
system32>format F: /fs:ntfs /q /v:Recovery /y
system32>exit
```



```

X:\I386\SYSTEM32\CMD.EXE
X:\I386\SYSTEM32>diskpart → Starts the Microsoft disk partitioning tool.

Microsoft DiskPart version 5.2.3790.1830
Copyright (C) 1999-2001 Microsoft Corporation.
On computer: MININT-JUC

DISKPART> list vol → Show partition information

   Volume ###  Ltr  Label          Fs      Type          Size      Status       Info
   -----  -  -  -  -  -  -  -  -
   Volume 0             X   CD_ROM        CDFS     DUD-ROM       405 MB     Healthy      Boot
   Volume 1             D                   FAT32    Removeable   3854 MB     Healthy

DISKPART> sel disk 0 → Select a disk

Disk 0 is now the selected disk.

DISKPART> create part pri size=2000 → Create partition 1 and assign a size.
                                       This partition is for OS installation.
DiskPart succeeded in creating the specified partition.

DISKPART> assign letter=N → Assign partition 1 a code name (N).
DiskPart successfully assigned the drive letter or mount point.

DISKPART> create part pri size=1800 → Create partition 2 and assign a size.
                                       This partition is for recovery images.
DiskPart succeeded in creating the specified partition.

DISKPART> assign letter=F → Assign partition 2 a code name (F).
DiskPart successfully assigned the drive letter or mount point.

DISKPART> exit → Exit diskpart

X:\I386\SYSTEM32>format n: /fs:ntfs /q /y → Format partition 1 (N) as NTFS format.
The type of the file system is RAW.
The new file system is NTFS.
QuickFormatting 2000M
Creating file system structures.
Format complete.
 2048254 KB total disk space.
 2035620 KB are available.

X:\I386\SYSTEM32>format f: /fs:ntfs /q /v:Recovery /y
The type of the file system is RAW.
The new file system is NTFS.
QuickFormatting 1804M
Creating file system structures.
Format complete.
 1847474 KB total disk space.
 1835860 KB are available.

X:\I386\SYSTEM32>exit → Exit Windows PE
    
```

Figure C-5: Partition Creation Commands



**NOTE:**

Use the following commands to check if the partitions were created successfully.

```
X:\I386\SYSTEM32>diskpart
Microsoft DiskPart version 5.2.3790.1830
Copyright (C) 1999-2001 Microsoft Corporation.
On computer: MININT-JUC

DISKPART> sel disk 0
Disk 0 is now the selected disk.

DISKPART> list part

   Partition ###   Type              Size              Offset
-----
   Partition 1     Primary           2000 MB           32 KB
   Partition 2     Primary           1804 MB           2000 MB

DISKPART> exit
```

**Step 6:** Press any key to exit the recovery tool and automatically reboot the system.  
Please continue to the following procedure: Build the Recovery Partition.

### C.2.3 Install Operating System, Drivers and Applications

Install the operating system onto the unlabelled partition. The partition labeled "Recovery" is for use by the system recovery tool and should not be used for installing the operating system or any applications.



**NOTE:**

The operating system installation program may offer to reformat the chosen partition. DO NOT format the partition again. The partition has already been formatted and is ready for installing the new operating system.

To install the operating system, insert the operating system installation CD into the optical drive. Restart the computer and follow the installation instructions.

### C.2.4 Building the Recovery Partition

- Step 1:** Put the recover CD in the optical drive.
- Step 2:** Start the system.
- Step 3:** **Boot the system from the recovery CD.** When prompted, press any key to boot from the recovery CD. It will take a while to launch the recovery tool. Please be patient!

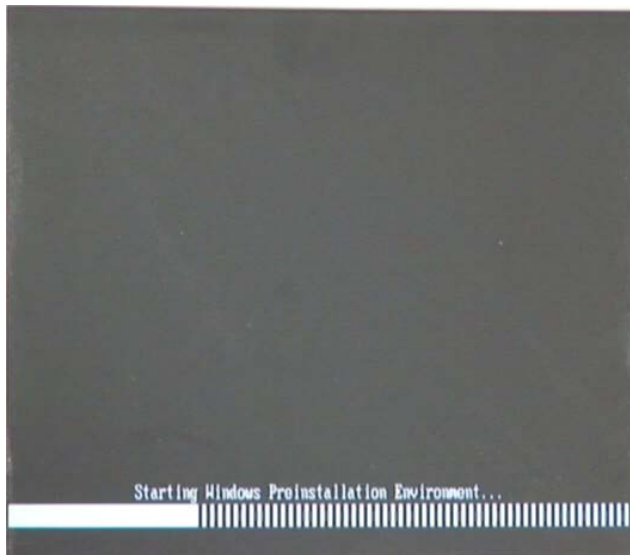


Figure C-6: Launching the Recovery Tool

- Step 4:** When the recovery tool setup menu appears, press <2> then <Enter>.

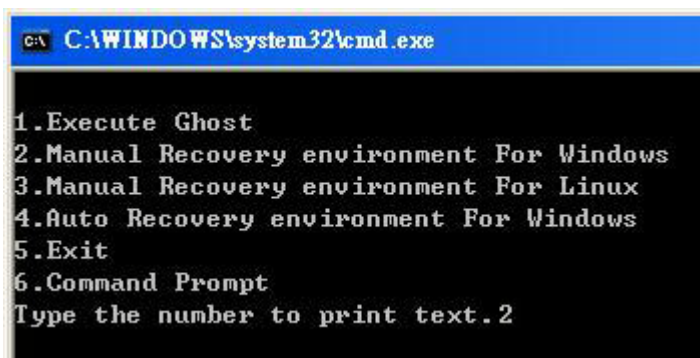
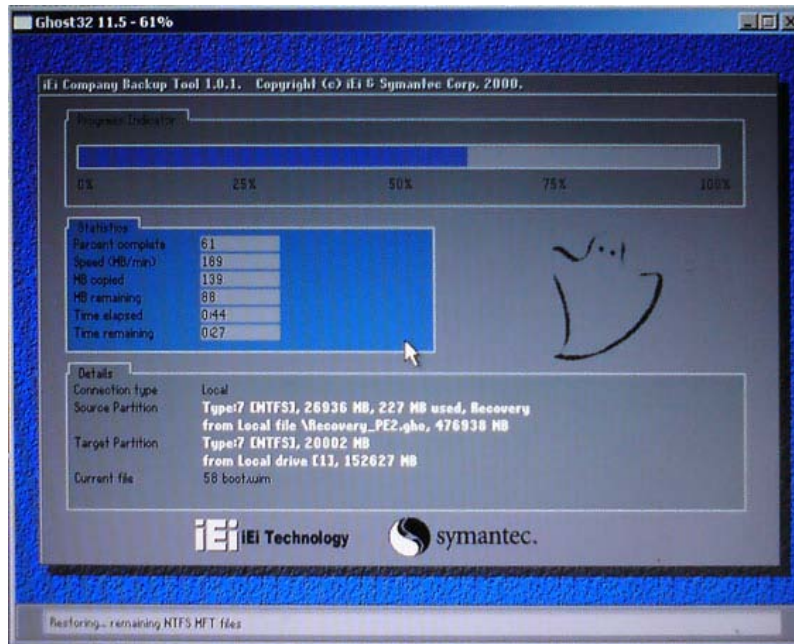


Figure C-7: Manual Recovery Environment for Windows

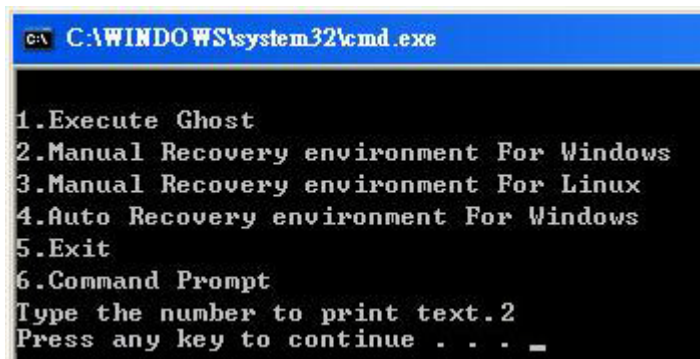


**Step 5:** The Symantec Ghost window appears and starts configuring the system to build a recovery partition. In this process the partition created for recovery files in **Section C.2.2** is hidden and the recovery tool is saved in this partition.



**Figure C-8: Building the Recovery Partition**

**Step 6:** After completing the system configuration, press any key in the following window to reboot the system.



**Figure C-9: Press Any Key to Continue**

**Step 7:** Eject the recovery CD.



### C.2.5 Create Factory Default Image

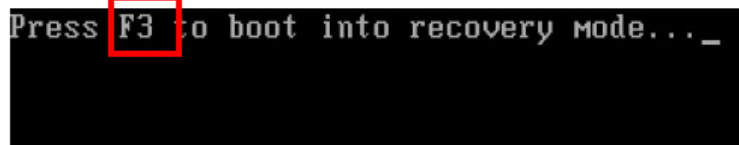


#### NOTE:

Before creating the factory default image, please configure the system to a factory default environment, including driver and application installations.

To create a factory default image, please follow the steps below.

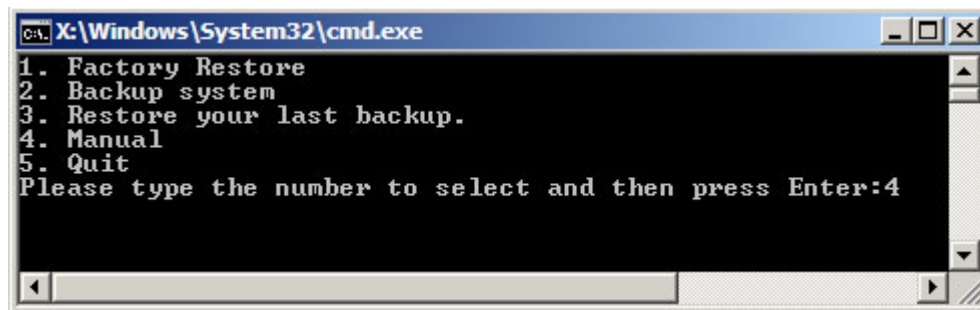
**Step 1:** Turn on the system. When the following screen displays (**Figure C-10**), press the <F3> key to access the recovery tool. The message will display for 10 seconds, please press F3 before the system boots into the operating system.



```
Press F3 to boot into recovery mode... _
```

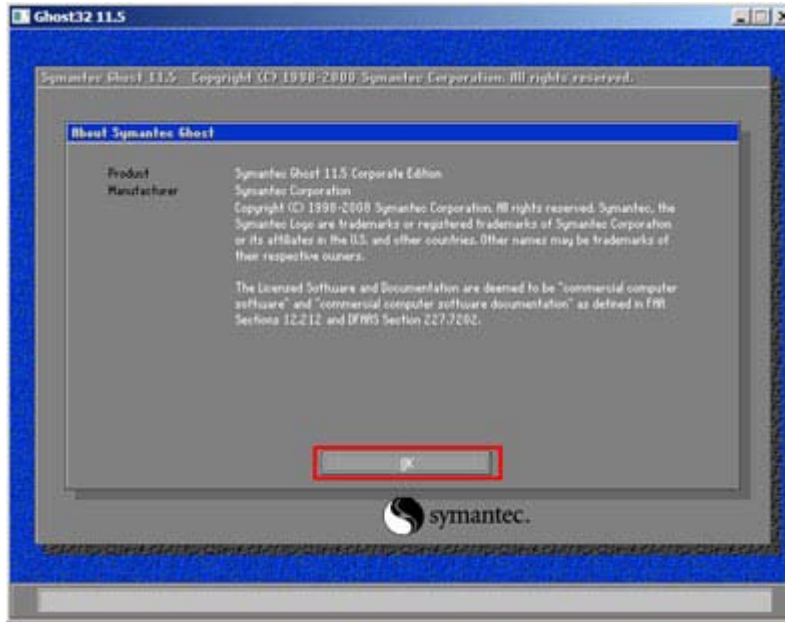
**Figure C-10: Press F3 to Boot into Recovery Mode**

**Step 2:** The recovery tool menu appears. Type <4> and press <Enter>. (**Figure C-11**)



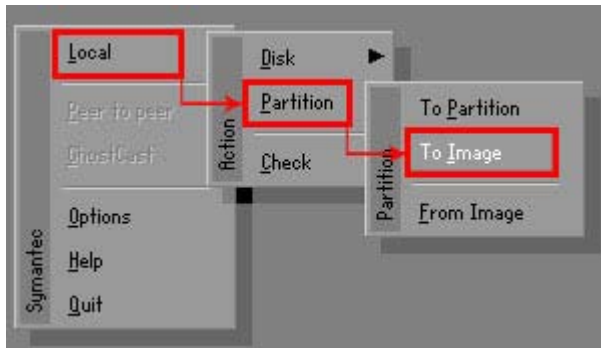
**Figure C-11: Recovery Tool Menu**

**Step 3:** The About Symantec Ghost window appears. Click **OK** button to continue.



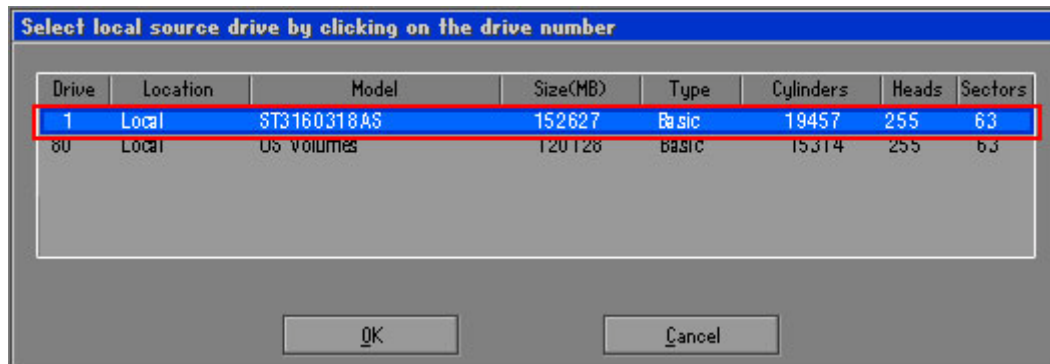
**Figure C-12: About Symantec Ghost Window**

**Step 4:** Use mouse to navigate to the option shown below (**Figure C-13**).



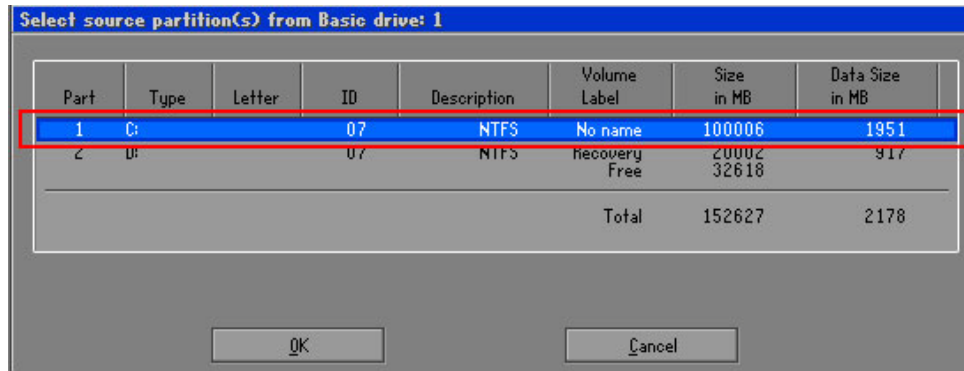
**Figure C-13: Symantec Ghost Path**

**Step 5:** Select the local source drive (Drive 1) as shown in **Figure C-14**. Then click OK.



**Figure C-14: Select a Local Source Drive**

**Step 6:** Select a source partition (Part 1) from basic drive as shown in **Figure C-15**. Then click OK.



**Figure C-15: Select a Source Partition from Basic Drive**

**Step 7:** Select **1.2: [Recovery] NTFS drive** and enter a file name called **iei** (**Figure C-16**). Click **Save**. The factory default image will then be saved in the selected recovery drive and named **IEI.GHO**.



**WARNING:**

The file name of the factory default image must be **iei.GHO**.

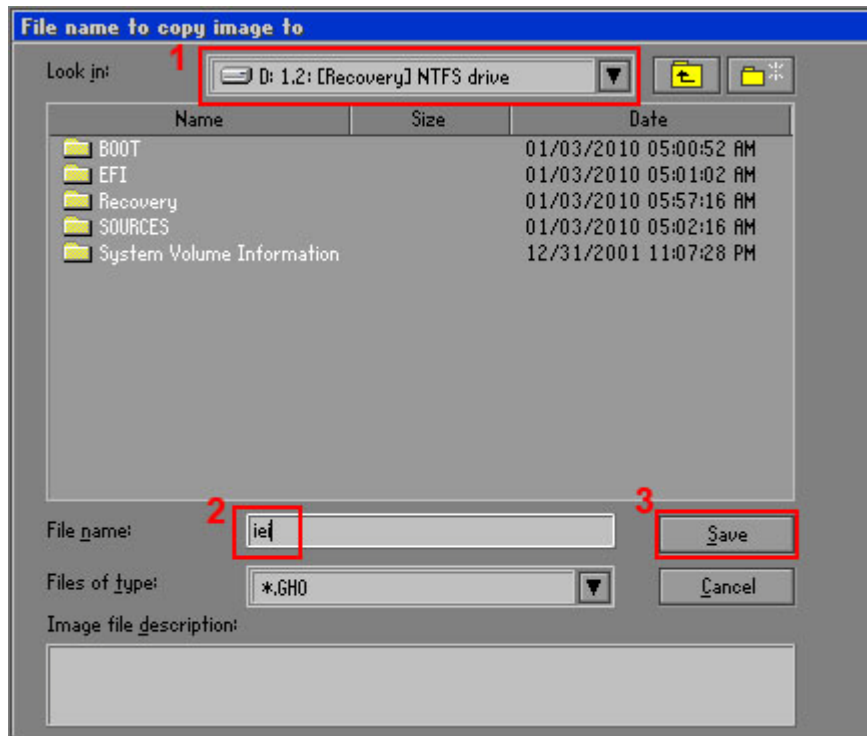


Figure C-16: File Name to Copy Image to

Step 8: When the Compress Image screen in **Figure C-17** prompts, click **High** to make the image file smaller.

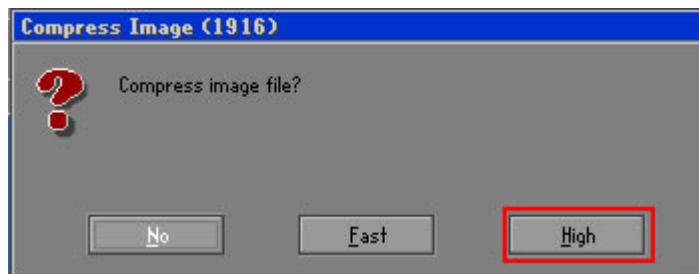
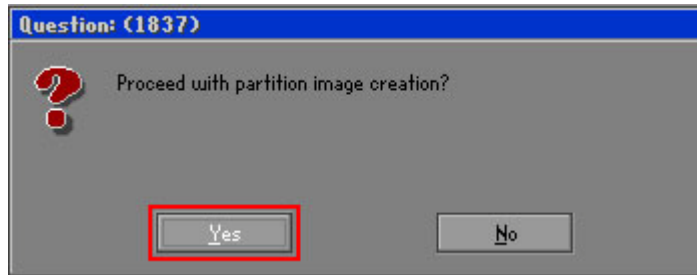


Figure C-17: Compress Image

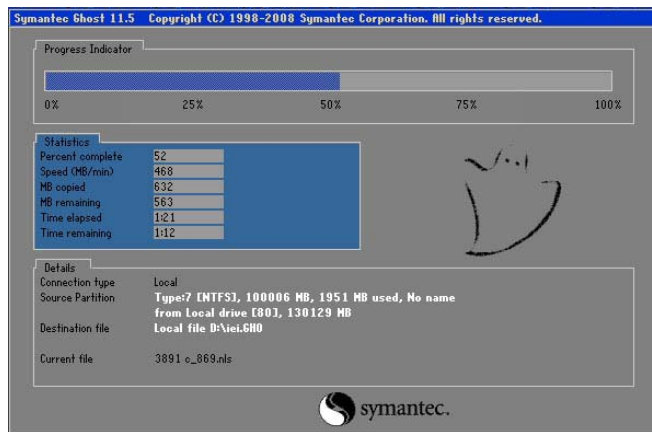


**Step 9:** The Proceed with partition image creation window appears, click **Yes** to continue.



**Figure C-18: Image Creation Confirmation**

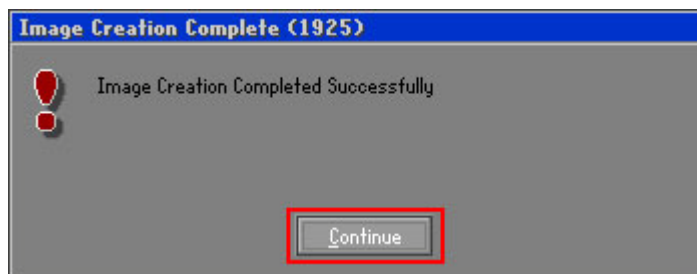
**Step 10:** The Symantec Ghost starts to create the factory default image (**Figure C-19**).



**Figure C-19: Image Creation Complete**

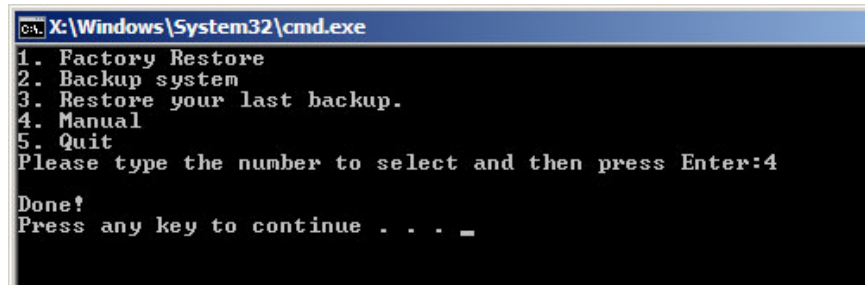
**Step 11:** When the image creation completes, a screen prompts as shown in **Figure C-20**.

Click **Continue** and close the Ghost window to exit the program.



**Figure C-20: Image Creation Complete**

**Step 12:** The recovery tool main menu window is shown as below. Press any key to reboot the system.



```
C:\Windows\System32\cmd.exe
1. Factory Restore
2. Backup system
3. Restore your last backup.
4. Manual
5. Quit
Please type the number to select and then press Enter:4
Done!
Press any key to continue . . . _
```

**Figure C-21: Press Any Key to Continue**

### C.3 Auto Recovery Setup Procedure

The auto recovery function allows a system to automatically restore from the factory default image after encountering a Blue Screen of Death (BSoD) or a hang for around 10 minutes. To use the auto recovery function, follow the steps described in the following sections.



#### **CAUTION:**

The setup procedure may include a step to create a factory default image. It is suggested to configure the system to a factory default environment before the configuration, including driver and application installations.

---

**Step 1:** Follow the steps described in **Section C.2.1 ~ Section C.2.3** to setup BIOS, create partitions and install operating system.

**Step 2:** Install the auto recovery utility into the system by double clicking the **Utility/AUTORECOVERY-SETUP.exe** in the One Key Recovery CD. This utility **MUST** be installed in the system, otherwise, the system will automatically restore from the factory default image every ten (10) minutes.



Figure C-22: Auto Recovery Utility

**Step 3:** Reboot the system from the recovery CD. When prompted, press any key to boot from the recovery CD. It will take a while to launch the recovery tool. Please be patient!



Figure C-23: Launching the Recovery Tool

**Step 4:** When the recovery tool setup menu appears, press <4> then <Enter>.

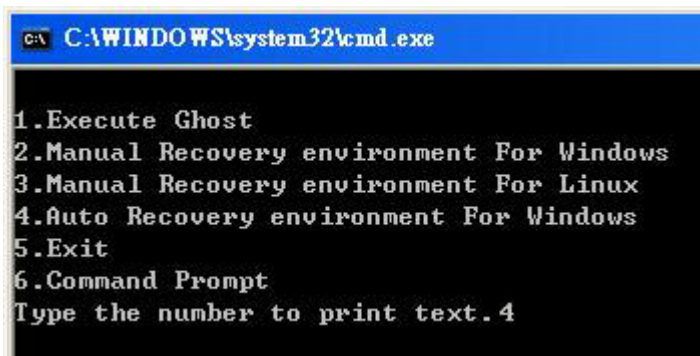
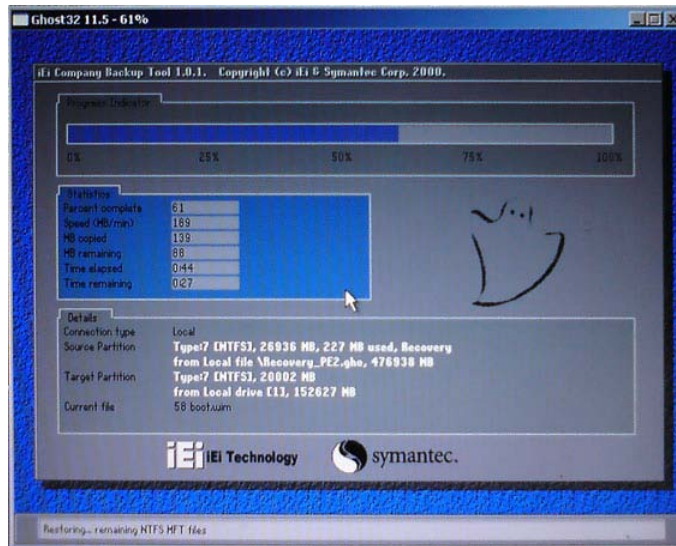


Figure C-24: Auto Recovery Environment for Windows



## ECN-780-Q67 Embedded System

**Step 5:** The Symantec Ghost window appears and starts configuring the system to build an auto recovery partition. In this process the partition created for recovery files in **Section C.2.2** is hidden and the auto recovery tool is saved in this partition.



**Figure C-25: Building the Auto Recovery Partition**

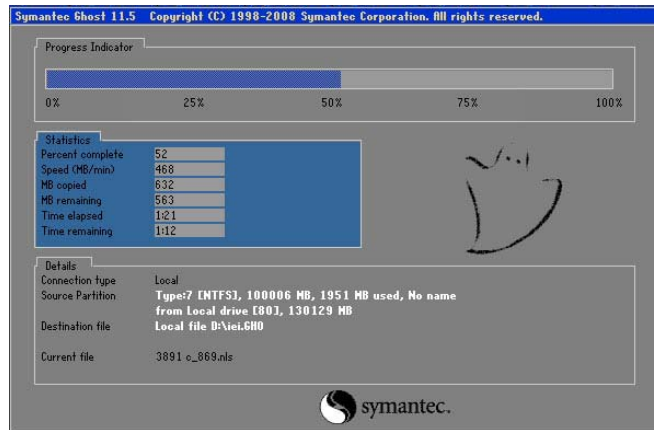
**Step 6:** After completing the system configuration, the following message prompts to confirm whether to create a factory default image. Type **Y** to have the system create a factory default image automatically. Type **N** within 6 seconds to skip this process (The default option is YES). It is suggested to choose YES for this option.



**Figure C-26: Factory Default Image Confirmation**

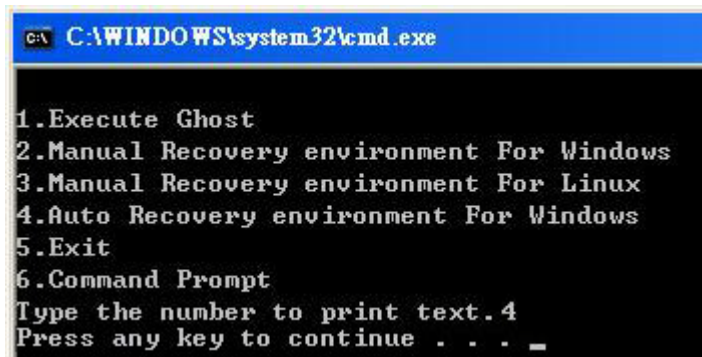


**Step 7:** The Symantec Ghost starts to create the factory default image (**Figure C-27**).



**Figure C-27: Image Creation Complete**

**Step 8:** After completing the system configuration, press any key in the following window to restart the system.

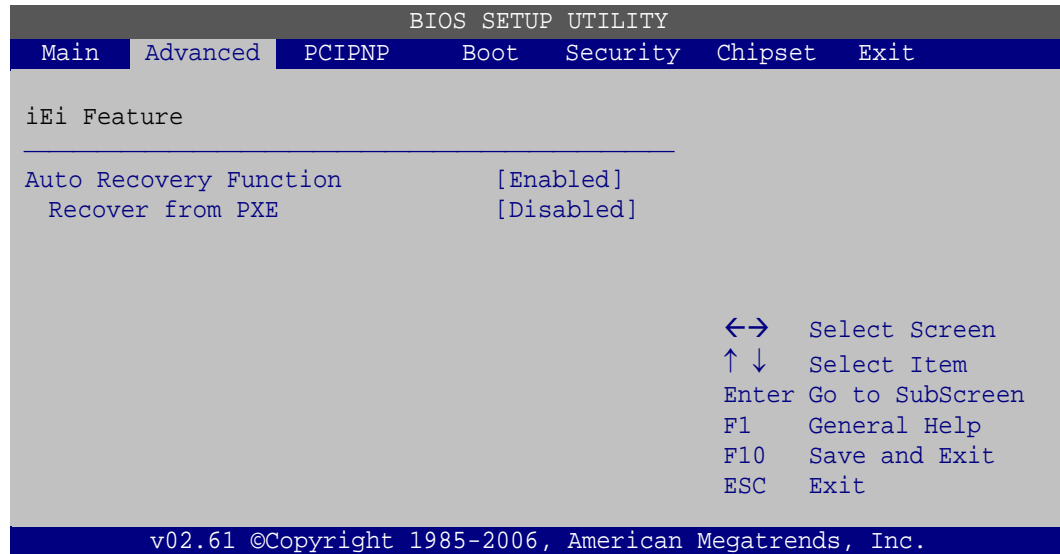


**Figure C-28: Press any key to continue**

**Step 9:** Eject the One Key Recovery CD and restart the system.

**Step 10:** Press the <DELETE> key as soon as the system is turned on to enter the BIOS.

**Step 11:** Enable the Auto Recovery Function option (**Advanced** → **iEi Feature** → **Auto Recovery Function**).



**BIOS Menu 26: iEi Feature**

**Step 12:** Save changes and restart the system. If the system encounters a Blue Screen of Death (BSoD) or a hang for around 10 minutes, it will automatically restore from the factory default image.



**CAUTION:**

The auto recovery function can only apply on a Microsoft Windows system running the following OS versions:

- Windows XP
- Windows Vista
- Windows 7

## C.4 Setup Procedure for Linux

The initial setup procedure for Linux system is mostly the same with the procedure for Microsoft Windows. Please follow the steps below to setup recovery tool for Linux OS.

**Step 1: Hardware and BIOS setup.** Refer to **Section C.2.1**.

**Step 2: Install Linux operating system.** Make sure to install GRUB (v0.97 or earlier) MBR type and Ext3 partition type. Leave enough space on the hard drive to create the recover partition later.



**NOTE:**

If the Linux OS is not installed with GRUB (v0.97 or earlier) and Ext3, the Symantec Ghost may not function properly.

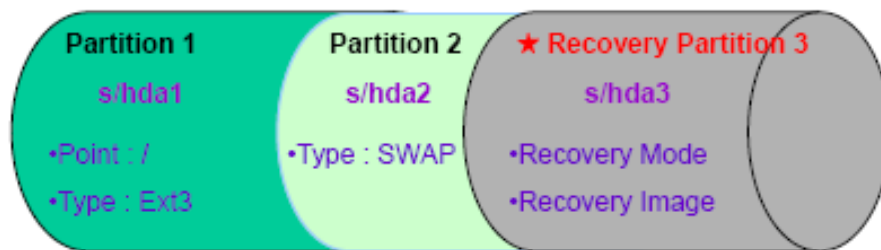
While installing Linux OS, please create two partitions:

- Partition 1: /
- Partition 2: **SWAP**



**NOTE:**

Please reserve enough space for partition 3 for saving recovery images.



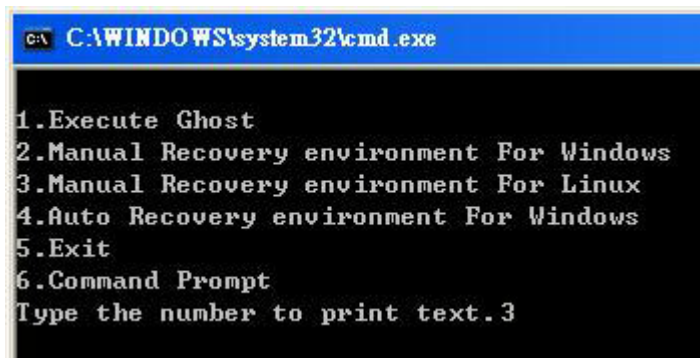
**Figure C-29: Partitions for Linux**

**Step 3: Create a recovery partition.** Insert the recovery CD into the optical disk drive. Follow **Step 1 ~ Step 3** described in **Section C.2.2**. Then type the following commands (marked in red) to create a partition for recovery images.

```
system32>diskpart
DISKPART>list vol
DISKPART>sel disk 0
```

```
DISKPART>create part pri size= ____  
DISKPART>assign letter=N  
DISKPART>exit  
system32>format N: /fs:ntfs /q /v:Recovery /y  
system32>exit
```

**Step 4:** Build the recovery partition. Press any key to boot from the recovery CD. It will take a while to launch the recovery tool. Please be patient. When the recovery tool setup menu appears, type <3> and press <Enter> (**Figure C-30**). The Symantec Ghost window appears and starts configuring the system to build a recovery partition. After completing the system configuration, press any key to reboot the system. Eject the recovery CD.



```
C:\WINDOWS\system32\cmd.exe  
1.Execute Ghost  
2.Manual Recovery environment For Windows  
3.Manual Recovery environment For Linux  
4.Auto Recovery environment For Windows  
5.Exit  
6.Command Prompt  
Type the number to print text.3
```

**Figure C-30: Manual Recovery Environment for Linux**

**Step 5:** Access the recovery tool main menu by modifying the “menu.lst”. To first access the recovery tool main menu, the menu.lst must be modified. In Linux, enter Administrator (root). When prompt appears, type:

```
cd /boot/grub  
vi menu.lst
```



```
Fedora release 9 (Sulphur)
Kernel 2.6.25-14.fc9.i686 on an i686 (tty2)

localhost login: root
Password:
[root@localhost ~]# cd /boot/grub/
[root@localhost grub]# vi menu.lst _
```

Figure C-31: Access menu.lst in Linux (Text Mode)

Step 6: Modify the menu.lst as shown below.

```
#boot=/dev/sda
default=0
timeout=10 ← Modify timeout=10
splashimage=(hd0,0)/grub/splash.xpm.gz
hiddenmenu
title Fedora (2.6.25-14.fc9.i686)
    root (hd0,0)
    kernel /vmlinuz-2.6.25-14.fc9.i686 ro root=UUID=10f1acda
    ac38b5c78910 rhgb quiet
    initrd /initrd-2.6.25-14.fc9.i686.img

title Recovery Partition
root (hd0,2) ← Type command
makeactive
chainloader +1
```

- Type command:  
**title Recovery Partition**  
**root (hd0,2)**  
**makeactive**  
**chainloader +1**

Step 7: The recovery tool menu appears. (Figure C-32)

```
1. Factory Restore
2. Backup system
3. Restore your last backup.
4. Manual
5. Quit
Please type the number to select and then press Enter:
```

Figure C-32: Recovery Tool Menu

Step 8: Create a factory default image. Follow Step 2 ~ Step 12 described in Section C.2.5 to create a factory default image.

## C.5 Recovery Tool Functions

After completing the initial setup procedures as described above, users can access the recovery tool by pressing <F3> while booting up the system. However, if the setup procedure in Section C.3 has been completed and the auto recovery function is enabled, the system will automatically restore from the factory default image without pressing the F3 key. The recovery tool main menu is shown below.

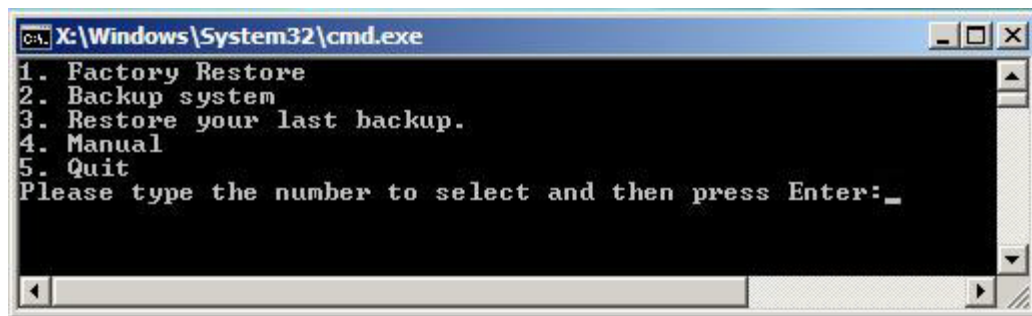


Figure C-33: Recovery Tool Main Menu

The recovery tool has several functions including:

1. **Factory Restore:** Restore the factory default image (iei.GHO) created in Section C.2.5.
2. **Backup system:** Create a system backup image (iei\_user.GHO) which will be saved in the hidden partition.
3. **Restore your last backup:** Restore the last system backup image
4. **Manual:** Enter the Symantec Ghost window to configure manually.
5. **Quit:** Exit the recovery tool and restart the system.



### WARNING:

Please do not turn off the system power during the process of system recovery or backup.


**WARNING:**

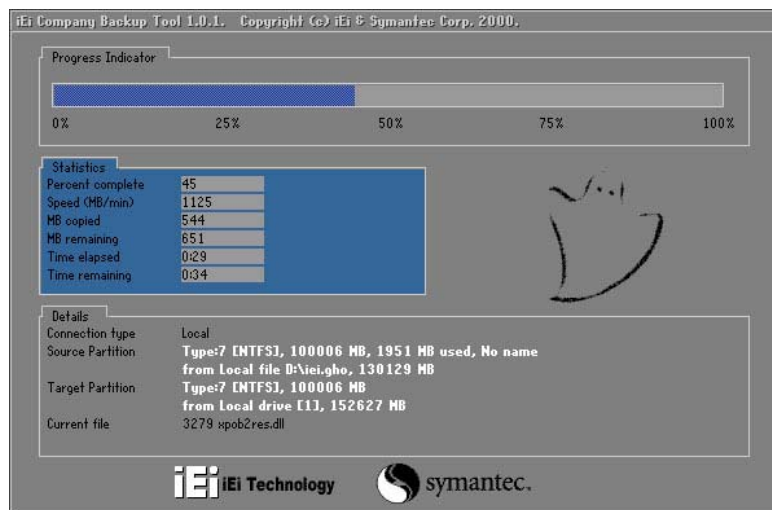
All data in the system will be deleted during the system recovery. Please backup the system files before restoring the system (either Factory Restore or Restore Backup).

### C.5.1 Factory Restore

To restore the factory default image, please follow the steps below.

**Step 1:** Type <1> and press <Enter> in the main menu.

**Step 2:** The Symantec Ghost window appears and starts to restore the factory default. A factory default image called **iei.GHO** is created in the hidden Recovery partition.



**Figure C-34: Restore Factory Default**

**Step 3:** The screen shown in **Figure C-35** appears when completed. Press any key to reboot the system.



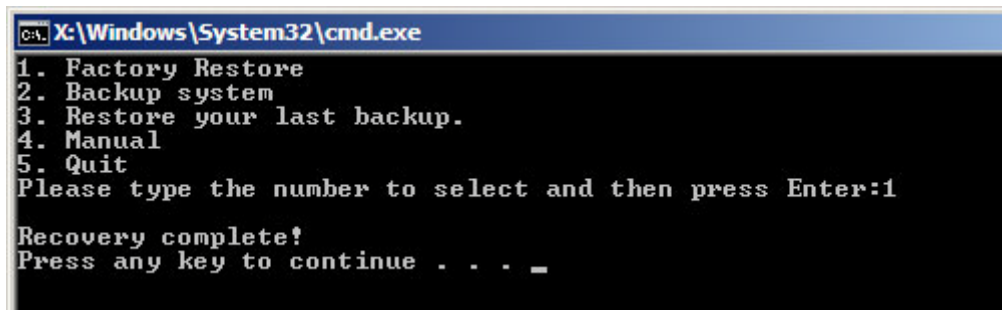


Figure C-35: Recovery Complete Window

### C.5.2 Backup System

To backup the system, please follow the steps below.

**Step 1:** Type <2> and press <Enter> in the main menu.

**Step 2:** The Symantec Ghost window appears and starts to backup the system. A backup image called **iei\_user.GHO** is created in the hidden Recovery partition.

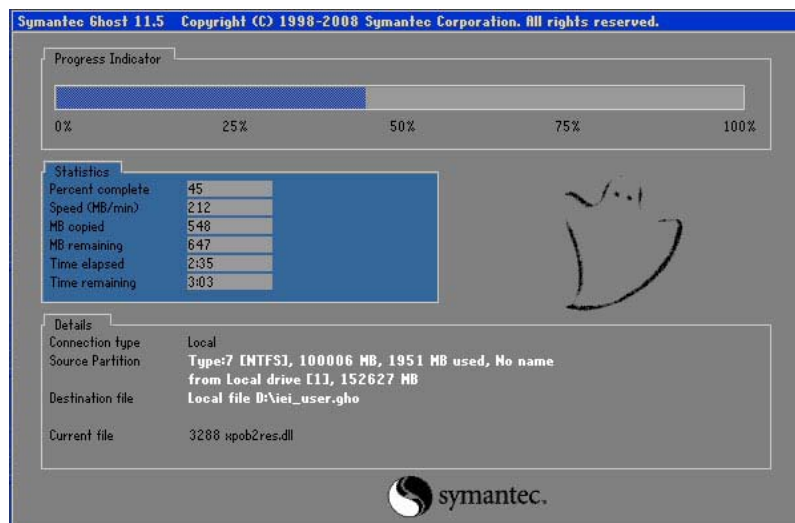


Figure C-36: Backup System

**Step 3:** The screen shown in **Figure C-37** appears when system backup is complete. Press any key to reboot the system.



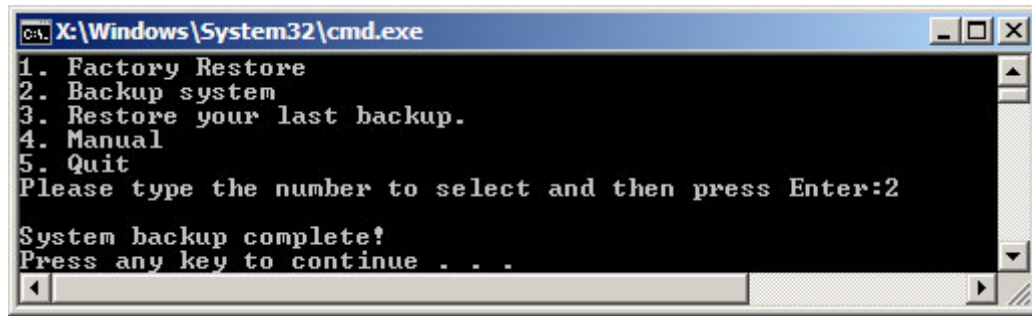


Figure C-37: System Backup Complete Window

### C.5.3 Restore Your Last Backup

To restore the last system backup, please follow the steps below.

**Step 1:** Type <3> and press <Enter> in the main menu.

**Step 2:** The Symantec Ghost window appears and starts to restore the last backup image (iei\_user.GHO).

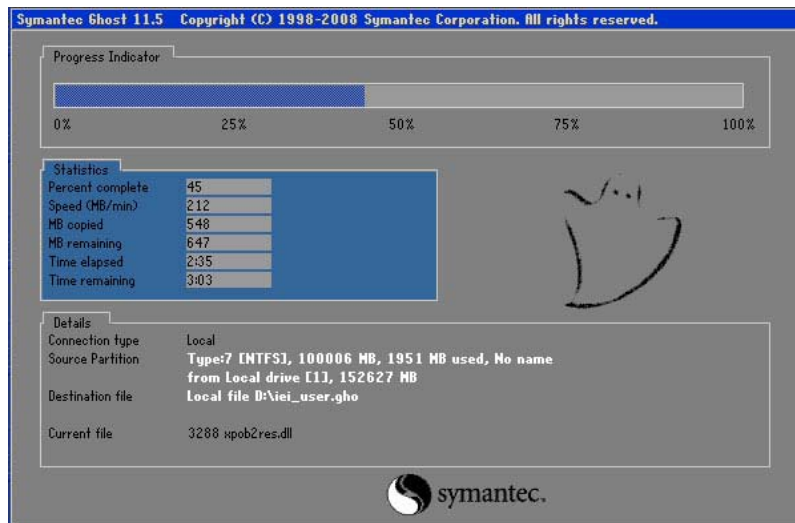
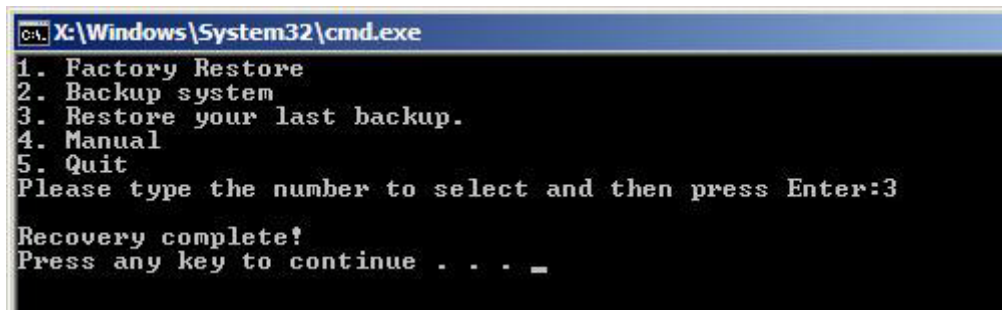


Figure C-38: Restore Backup

**Step 3:** The screen shown in **Figure C-39** appears when backup recovery is complete. Press any key to reboot the system.



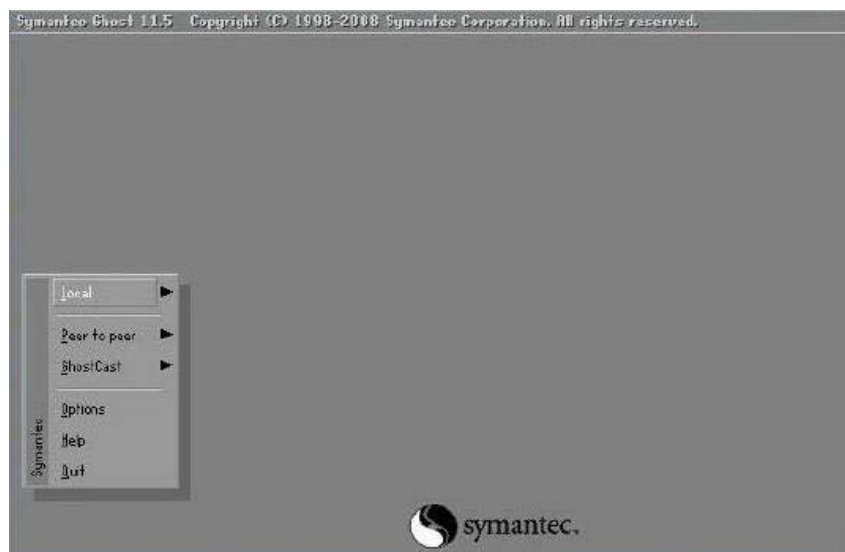
**Figure C-39: Restore System Backup Complete Window**

### C.5.4 Manual

To restore the last system backup, please follow the steps below.

**Step 1:** Type <4> and press <Enter> in the main menu.

**Step 2:** The Symantec Ghost window appears. Use the Ghost program to backup or recover the system manually.

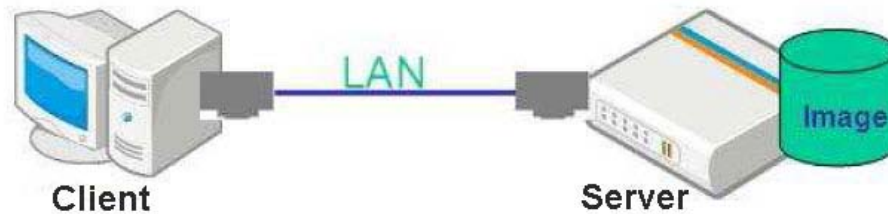


**Figure C-40: Symantec Ghost Window**

**Step 3:** When backup or recovery is completed, press any key to reboot the system.

## C.6 Restore Systems from a Linux Server through LAN

The One Key Recovery allows a client system to automatically restore to a factory default image saved in a Linux system (the server) through LAN connectivity after encountering a Blue Screen of Death (BSOD) or a hang for around 10 minutes. To be able to use this function, the client system and the Linux system MUST reside in the same domain.



### NOTE:

The supported client OS includes:

- Windows 2000
- Windows XP
- Windows Vista
- Windows 7
- Windows CE
- Windows XP Embedded

Prior to restoring client systems from a Linux server, a few setup procedures are required.

**Step 1:** Configure DHCP server settings

**Step 2:** Configure TFTP settings

**Step 3:** Configure One Key Recovery server settings

**Step 4:** Start DHCP, TFTP and HTTP

**Step 5:** Create a shared directory

**Step 6:** Setup a client system for auto recovery

The detailed descriptions are described in the following sections. In this document, two types of Linux OS are used as examples to explain the configuration process – CentOS 5.5 (Kernel 2.6.18) and Debian 5.0.7 (Kernel 2.6.26).

## C.6.1 Configure DHCP Server Settings

**Step 1:** Install the DHCP

`#yum install dhcp` (CentOS, commands marked in red)

`#apt-get install dhcp3-server` (Debian, commands marked in blue)

**Step 2:** Confirm the operating system default settings: dhcpd.conf.

### CentOS

Use the following command to show the DHCP server sample location:

`#vi /etc/dhcpd.conf`

The DHCP server sample location is shown as below:

```
# DHCP Server Configuration file.
# see /usr/share/doc/dhcp*/dhcpd.conf.sample
#
```

Use the following command to copy the DHCP server sample to etc/dhcpd.conf:

`#cp /usr/share/doc/dhcp-3.0.5/dhcpd.conf.sample /etc/dhcpd.conf`

`#vi /etc/dhcpd.conf`

```
ddns-update-style interim;
ignore client-updates;

subnet 192.168.0.0 netmask 255.255.255.0 {
# --- default gateway
    option routers                192.168.0.2;
    option subnet-mask            255.255.255.0;

    option nis-domain              "domain.org";
    option domain-name            "domain.org";
    option domain-name-servers    192.168.0.1;
    next-server 192.168.0.6;
    filename "pxelinux.0";
    option time-offset            -18000; # Eastern Standard Time
    option ntp-servers            192.168.1.1;
}
```

### Debian

`#vi /etc/dhcpd.conf`

Edit “/etc/dhcpd.conf” for your environment. For example, add

`next-server PXE server IP address;`



filename "pxelinux.0";

```

ddns-update-style interim;
ignore client-updates;

subnet 192.168.0.0 netmask 255.255.255.0 {
# --- default gateway
    option routers                192.168.0.2;
    option subnet-mask            255.255.255.0;

    option nis-domain             "domain.org";
    option domain-name            "domain.org";
    option domain-name-servers    192.168.0.1;
    next-server 192.168.0.6;
    filename "pxelinux.0";
    option time-offset             -18000; # Eastern Standard Time
    option ntp-servers             192.168.1.1;
}
    
```

### C.6.2 Configure TFTP Settings

**Step 1:** Install the tftp, httpd and syslinux.

`#yum install tftp-server httpd syslinux` (CentOS)

`#apt-get install tftpd-hpa xinetd syslinux` (Debian)

**Step 2:** Enable the TFTP server by editing the "/etc/xinetd.d/tftp" file and make it use the remap file. The "-vvv" is optional but it could definitely help on getting more information while running the remap file. For example:

#### CentOS

`#vi /etc/xinetd.d/tftp`

Modify:

`disable = no`

`server_args = -s /tftpboot -m /tftpboot/tftpd.remap -vvv_`

```

socket_type      = dgram
protocol        = udp
wait            = yes
user            = root
server          = /usr/sbin/in.tftpd
server_args     = -s /tftpboot -m /tftpboot/tftpd.remap -vvv
disable         = no
per_source      = 11
cps             = 100 2
flags           = IPv4
    
```

### Debian

Replace the TFTP settings from “inetd” to “xinetd” and annotate the “inetd” by adding “#”.

`#vi /etc/inetd.conf`

Modify: `#tftp dgram udp wait root /usr/sbin.....` (as shown below)

```
#:BOOT: TFTP service is provided primarily for booting. Most sites
# run this only on machines acting as "boot servers."
#tftp dgram udp wait root /usr/sbin/in.tftpd /usr/sbin/in.tftpd -s
/var/lib/tftpboot
```

`#vi /etc/xinetd.d/tftp`

```
socket_type      = dgram
protocol        = udp
wait            = yes
user            = root
server          = /usr/sbin/in.tftpd
server_args     = -s /tftpboot -m /tftpboot/tftpd.remap -vvv
disable         = no
per_source      = 11
cps             = 100 2
flags           = IPv4
```

### C.6.3 Configure One Key Recovery Server Settings

**Step 1:** Copy the **Utility/RECOVERYR10.TAR.BZ2** package from the One Key Recovery CD to the system (server side).



**Step 2:** Extract the recovery package to /.

```
#cp RecoveryR10.tar.bz2 /
#cd /
#tar -xvjf RecoveryR10.tar.bz2
```

**Step 3:** Copy “pxelinux.0” from “syslinux” and install to “tftpboot”.

```
#cp /usr/lib/syslinux/pxelinux.0 /tftpboot/
```

### C.6.4 Start the DHCP, TFTP and HTTP

Start the DHCP, TFTP and HTTP. For example:

#### CentOS

```
#service xinetd restart
```

```
#service httpd restart
```

```
#service dhcpd restart
```

#### Debian

```
#/etc/init.d/xinetd reload
```

```
#/etc/init.d/xinetd restart
```

```
#/etc/init.d/dhcp3-server restart
```

### C.6.5 Create Shared Directory

**Step 1:** Install the samba.

```
#yum install samba
```

**Step 2:** Create a shared directory for the factory default image.

```
#mkdir /share
```

```
#cd /share
```

```
#mkdir /image
```

```
#cp iei.gho /image
```



#### **WARNING:**

The file name of the factory default image must be **iei.gho**.

---

**Step 3:** Confirm the operating system default settings: smb.conf.

```
#vi /etc/samba/smb.conf
```

Modify:

[image]

comment = One Key Recovery

path = /share/image

browseable = yes

writable = yes

public = yes

create mask = 0644

directory mask = 0755

**Step 4:** Edit "/etc/samba/smb.conf" for your environment. For example:

```
# "security = user" is always a good idea. This will require a Unix account
# in this server for every user accessing the server. See
# /usr/share/doc/samba-doc/htmldocs/Samba3-HOWTO/ServerType.html
# in the samba-doc package for details.
security = share
```

```
[image]
comment = One Key Recovery
path = /share/image
browseable = yes
writable = yes
public = yes
create mask = 0644
directory mask = 0755
```

**Step 5:** Modify the hostname

```
#vi /etc/hostname
```

Modify: RecoveryServer

```
RecoveryServer
```

## C.6.6 Setup a Client System for Auto Recovery

**Step 1:** Configure the following BIOS options of the client system.

Advanced → iEi Feature → Auto Recovery Function → **Enabled**

Advanced → iEi Feature → Recover from PXE → **Enabled**

Boot → Launch PXE OpROM → **Enabled**



**Step 2:** Continue to configure the **Boot Option Priorities** BIOS option of the client system:

Boot Option #1 → remain the default setting to boot from the original OS.

Boot Option #2 → select the boot from LAN option.

**Step 3:** Save changes and exit BIOS menu.

Exit → **Save Changes and Exit**

**Step 4:** Install the auto recovery utility into the system by double clicking the **Utility/AUTORECOVERY-SETUP.exe** in the One Key Recovery CD. This utility **MUST** be installed in the system, otherwise, the system will automatically restore from the factory default image every ten (10) minutes.



**Step 5:** Restart the client system from LAN. If the system encounters a Blue Screen of Death (BSoD) or a hang for around 10 minutes, it will automatically restore from the factory default image. The following screens will show when the system starts auto recovering.

```
Realtek PCIe GBE Family Controller Series v2.35 (06/14/10)
CLIENT MAC ADDR: 00 18 7D 13 E6 89  GUID: 00020003-0004-0005-0006-0007000000
DHCP . ./
```

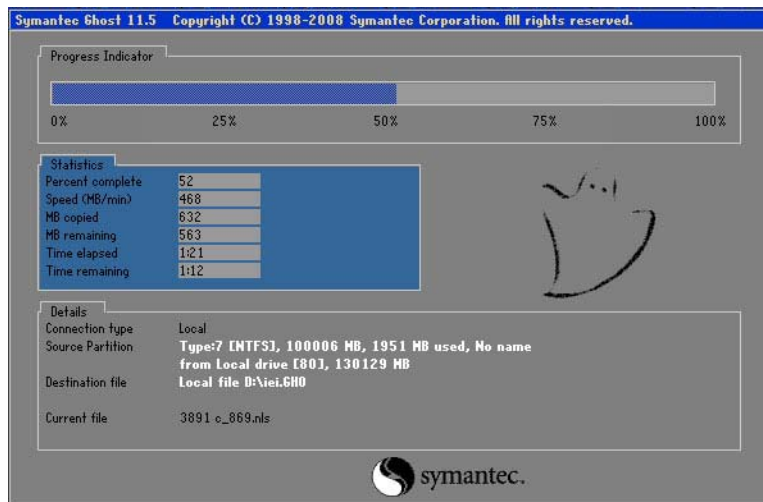
```

My IP address seems to be C0A80009 192.168.0.9
ip=192.168.0.9:192.168.0.8:192.168.0.2:255.255.255.0
TFTP prefix:
Trying to load: pxelinux.cfg/00020003-0004-0005-0006-000700080009
Trying to load: pxelinux.cfg/01-00-18-7d-13-e6-89
Trying to load: pxelinux.cfg/C0A80009
Trying to load: pxelinux.cfg/C0A8000
Trying to load: pxelinux.cfg/C0A800
Trying to load: pxelinux.cfg/C0A80
Trying to load: pxelinux.cfg/C0A8
Trying to load: pxelinux.cfg/C0A
Trying to load: pxelinux.cfg/C0
Trying to load: pxelinux.cfg/C
Trying to load: pxelinux.cfg/default
boot:
    
```

```

Windows is loading files...

IP: 192.168.0.8, File: \Boot\WinPE.wim
    
```



Symantec Ghost 11.5 Copyright (C) 1998-2008 Symantec Corporation. All rights reserved.

Progress Indicator: 0% 25% 50% 75% 100%

Statistics	
Percent complete	52
Speed (MB/min)	468
MB copied	632
MB remaining	563
Time elapsed	1:21
Time remaining	1:12

Handwritten mark: 2011

Details	
Connection type	Local
Source Partition	Type:7 [NTFS], 100006 MB, 1951 MB used, No name from Local drive [80], 130129 MB
Destination file	Local file D:\iei.GHO
Current file	3891_e_869.nls

symantec.



**NOTE:**

A firewall or a SELinux is not in use in the whole setup process. If there is a firewall or a SELinux protecting the system, modify the configuration information to accommodate them.

## C.7 Other Information

### C.7.1 Using AHCI Mode or ALi M5283 / VIA VT6421A Controller

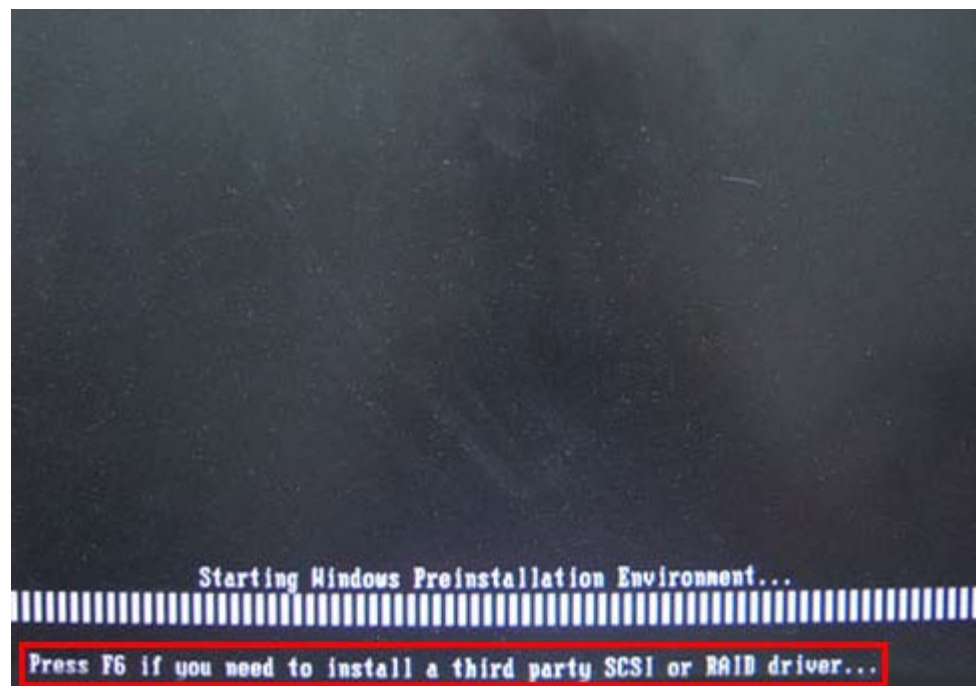
When the system uses AHCI mode or some specific SATA controllers such as ALi M5283 or VIA VT6421A, the SATA RAID/AHCI driver must be installed before using one key recovery. Please follow the steps below to install the SATA RAID/AHCI driver.

**Step 1:** Copy the SATA RAID/AHCI driver to a floppy disk and insert the floppy disk into a USB floppy disk drive. The SATA RAID/AHCI driver must be especially designed for the on-board SATA controller.

**Step 2:** Connect the USB floppy disk drive to the system.

**Step 3:** Insert the One Key Recovery CD into the system and boot the system from the CD.

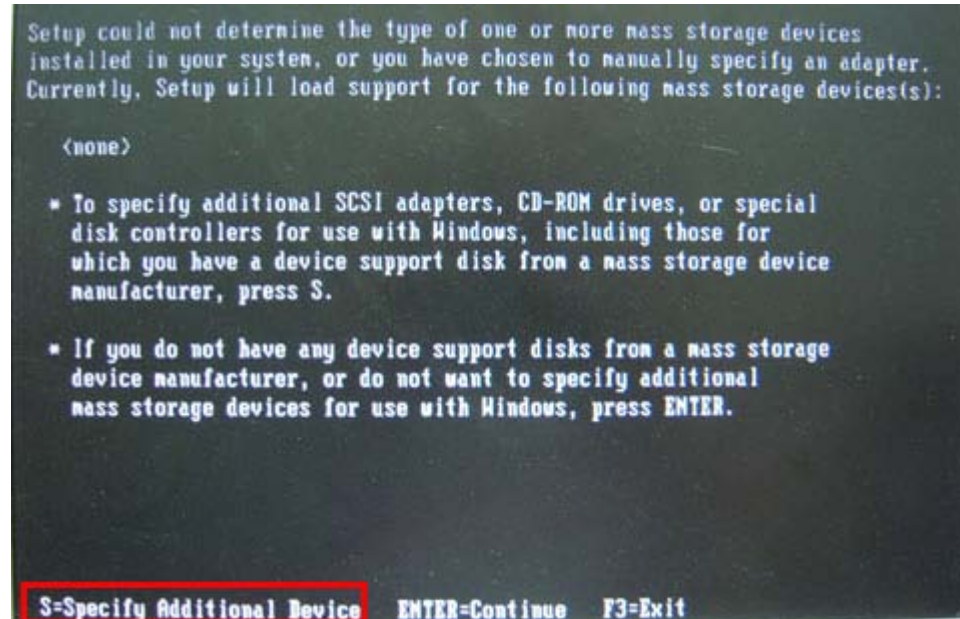
**Step 4:** When launching the recovery tool, press <F6>.



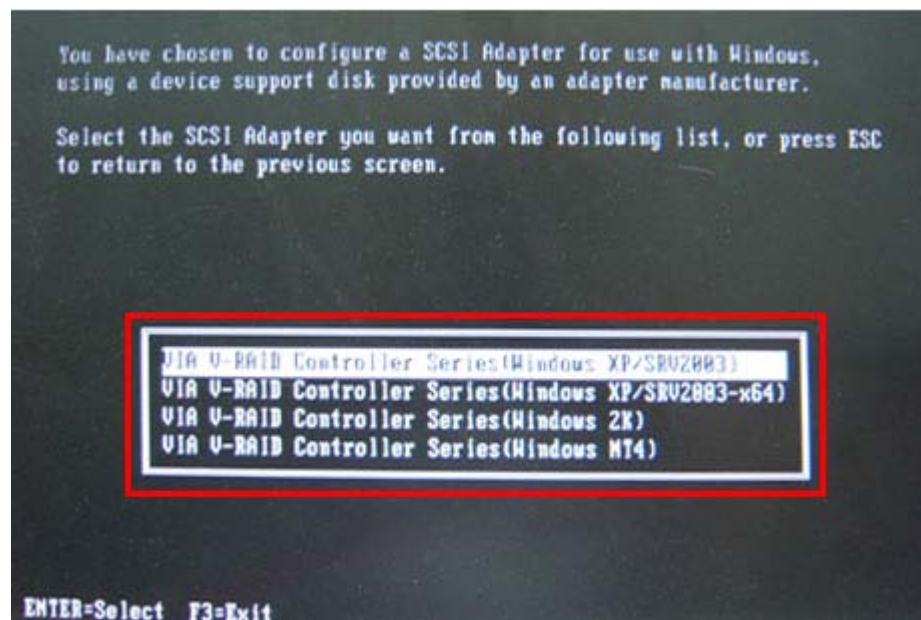


## ECN-780-Q67 Embedded System

**Step 5:** When the following window appears, press <S> to select “Specify Additional Device”.



**Step 6:** In the following window, select a SATA controller mode used in the system. Then press <Enter>. The user can now start using the SATA HDD.





**Step 7:** After pressing <Enter>, the system will get into the recovery tool setup menu.

Continue to follow the setup procedure from **Step 4** in **Section C.2.2 Create Partitions** to finish the whole setup process.

### C.7.2 System Memory Requirement

To be able to access the recovery tool by pressing <F3> while booting up the system, please make sure to have enough system memory. The minimum memory requirement is listed below.

- **Using Award BIOS:** 128 MB system memory
- **Using AMI BIOS:** 512 MB system memory.

Appendix

D

# Watchdog Timer

---


**NOTE:**

The following discussion applies to DOS environment. IEI support is contacted or the IEI website visited for specific drivers for more sophisticated operating systems, e.g., Windows and Linux.

The Watchdog Timer is provided to ensure that standalone systems can always recover from catastrophic conditions that cause the CPU to crash. This condition may have occurred by external EMI or a software bug. When the CPU stops working correctly, Watchdog Timer either performs a hardware reset (cold boot) or a Non-Maskable Interrupt (NMI) to bring the system back to a known state.

A BIOS function call (INT 15H) is used to control the Watchdog Timer:

**INT 15H:**

AH – 6FH Sub-function:	
AL – 2:	Sets the Watchdog Timer's period.
BL:	Time-out value (Its unit-second is dependent on the item "Watchdog Timer unit select" in CMOS setup).

**Table D-1: AH-6FH Sub-function**

Call sub-function 2 to set the time-out period of Watchdog Timer first. If the time-out value is not zero, the Watchdog Timer starts counting down. While the timer value reaches zero, the system resets. To ensure that this reset condition does not occur, calling sub-function 2 must periodically refresh the Watchdog Timer. However, the Watchdog timer is disabled if the time-out value is set to zero.

A tolerance of at least 10% must be maintained to avoid unknown routines within the operating system (DOS), such as disk I/O that can be very time-consuming.

**NOTE:**

When exiting a program it is necessary to disable the Watchdog Timer, otherwise the system resets.

**Example program:**

```
; INITIAL TIMER PERIOD COUNTER
;
W_LOOP:

    MOV     AX, 6F02H      ;setting the time-out value
    MOV     BL, 05        ;time-out value is 5 seconds
    INT     15H

;
; ADD THE APPLICATION PROGRAM HERE
;

    CMP     EXIT_AP, 1    ;is the application over?
    JNE     W_LOOP       ;No, restart the application

    MOV     AX, 6F02H    ;disable Watchdog Timer
    MOV     BL, 0        ;
    INT     15H

;
; EXIT ;
```



Appendix

E

# Hazardous Materials Disclosure

---

## E.1 Hazardous Materials Disclosure Table for IPB Products Certified as RoHS Compliant Under 2002/95/EC Without Mercury

The details provided in this appendix are to ensure that the product is compliant with the Peoples Republic of China (China) RoHS standards. The table below acknowledges the presences of small quantities of certain materials in the product, and is applicable to China RoHS only.

A label will be placed on each product to indicate the estimated “Environmentally Friendly Use Period” (EFUP). This is an estimate of the number of years that these substances would “not leak out or undergo abrupt change.” This product may contain replaceable sub-assemblies/components which have a shorter EFUP such as batteries and lamps. These components will be separately marked.

Please refer to the table on the next page.

Part Name	Toxic or Hazardous Substances and Elements					
	Lead (Pb)	Mercury (Hg)	Cadmium (Cd)	Hexavalent Chromium (CR(VI))	Polybrominated Biphenyls (PBB)	Polybrominated Diphenyl Ethers (PBDE)
Housing	X	O	O	O	O	X
Display	X	O	O	O	O	X
Printed Circuit Board	X	O	O	O	O	X
Metal Fasteners	X	O	O	O	O	O
Cable Assembly	X	O	O	O	O	X
Fan Assembly	X	O	O	O	O	X
Power Supply Assemblies	X	O	O	O	O	X
Battery	O	O	O	O	O	O
O: This toxic or hazardous substance is contained in all of the homogeneous materials for the part is below the limit requirement in SJ/T11363-2006 X: This toxic or hazardous substance is contained in at least one of the homogeneous materials for this part is above the limit requirement in SJ/T11363-2006						

## ECN-780-Q67 Embedded System

此附件旨在确保本产品符合中国 RoHS 标准。以下表格标示此产品中某有毒物质的含量符合中国 RoHS 标准规定的限量要求。

本产品上会附有“环境友好使用期限”的标签，此期限是估算这些物质“不会有泄漏或突变”的年限。本产品可能包含有较短的环境友好使用期限的可替换元件，像是电池或灯管，这些元件将会单独标示出来。

部件名称	有毒有害物质或元素					
	铅 (Pb)	汞 (Hg)	镉 (Cd)	六价铬 (CR(VI))	多溴联苯 (PBB)	多溴二苯 醚 (PBDE)
壳体	X	O	O	O	O	X
显示	X	O	O	O	O	X
印刷电路板	X	O	O	O	O	X
金属螺帽	X	O	O	O	O	O
电缆组装	X	O	O	O	O	X
风扇组装	X	O	O	O	O	X
电力供应组装	X	O	O	O	O	X
电池	O	O	O	O	O	O

O: 表示该有毒有害物质在该部件所有物质材料中的含量均在 SJ/T11363-2006 标准规定的限量要求以下。  
X: 表示该有毒有害物质至少在该部件的某一均质材料中的含量超出 SJ/T11363-2006 标准规定的限量要求。