



IEI Technology Corp.



MODEL:
TANK-GM45

**Wide Range Temperature Fanless Embedded System
with VGA, Gigabit Ethernet, Four USB,
RS-232/422/485, RoHS Compliant**

User Manual

Rev. 1.00 – 15 June 2010





Revision

| Date | Version | Changes |
|--------------|---------|-----------------|
| 15 June 2010 | 1.00 | Initial release |

Copyright

COPYRIGHT NOTICE

The information in this document is subject to change without prior notice in order to improve reliability, design and function and does not represent a commitment on the part of the manufacturer.

In no event will the manufacturer be liable for direct, indirect, special, incidental, or consequential damages arising out of the use or inability to use the product or documentation, even if advised of the possibility of such damages.

This document contains proprietary information protected by copyright. All rights are reserved. No part of this manual may be reproduced by any mechanical, electronic, or other means in any form without prior written permission of the manufacturer.

TRADEMARKS

All registered trademarks and product names mentioned herein are used for identification purposes only and may be trademarks and/or registered trademarks of their respective owners.

Table of Contents

| | |
|---|-----------|
| 1 INTRODUCTION..... | 1 |
| 1.1 OVERVIEW..... | 2 |
| 1.2 MODEL VARIATIONS | 2 |
| 1.3 BENEFITS | 2 |
| 1.4 FEATURES..... | 3 |
| 1.5 TECHNICAL SPECIFICATIONS | 3 |
| 1.6 CONNECTOR PANEL..... | 5 |
| 1.7 DIMENSIONS..... | 6 |
| 2 UNPACKING | 7 |
| 2.1 ANTI-STATIC PRECAUTIONS | 8 |
| 2.2 UNPACKING PRECAUTIONS..... | 8 |
| 2.3 UNPACKING CHECKLIST | 9 |
| 3 INSTALLATION | 10 |
| 3.1 INSTALLATION PRECAUTIONS | 11 |
| 3.2 HARD DISK DRIVE (HDD) INSTALLATION..... | 11 |
| 3.3 JUMPER SETTINGS | 14 |
| 3.3.1 COM3 RS-422/485 Setup..... | 15 |
| 3.4 EXTERNAL PERIPHERAL INTERFACE CONNECTORS..... | 15 |
| 3.4.1 LAN Connectors..... | 16 |
| 3.4.2 Keyboard/Mouse Connector | 18 |
| 3.4.3 Power Input..... | 18 |
| 3.4.4 Remote Control Connector | 19 |
| 3.4.5 RS-232 Serial Port Connector | 20 |
| 3.4.6 RS-422/485 Serial Port Connector | 21 |
| 3.4.7 USB Connector | 22 |
| 3.4.8 VGA Connector..... | 23 |
| 3.4.9 AT/ATX Power Mode Selection..... | 25 |
| 4 BIOS..... | 26 |

TANK-GM45 Embedded System

| | |
|---|-----------|
| 4.1 INTRODUCTION..... | 27 |
| 4.1.1 Starting Setup..... | 27 |
| 4.1.2 Using Setup..... | 27 |
| 4.1.3 Getting Help..... | 28 |
| 4.1.4 Unable to Reboot After Configuration Changes..... | 28 |
| 4.1.5 BIOS Menu Bar..... | 28 |
| 4.2 MAIN..... | 29 |
| 4.3 ADVANCED..... | 30 |
| 4.3.1 CPU Configuration..... | 31 |
| 4.3.2 IDE Configuration..... | 32 |
| 4.3.2.1 SATA Channel..... | 34 |
| 4.3.3 Super IO Configuration..... | 38 |
| 4.3.4 Hardware Health Configuration..... | 39 |
| 4.3.5 AHCI Configuration..... | 40 |
| 4.3.5.1 AHCI Port n..... | 41 |
| 4.3.6 Remote Access Configuration..... | 42 |
| 4.3.7 USB Configuration..... | 45 |
| 4.3.8 Power Configuration..... | 46 |
| 4.4 PCI/PNP..... | 47 |
| 4.5 BOOT..... | 49 |
| 4.5.1 Boot Settings Configuration..... | 50 |
| 4.5.2 Boot Device Priority..... | 52 |
| 4.5.3 Hard Disk Drives..... | 53 |
| 4.6 SECURITY..... | 53 |
| 4.7 CHIPSET..... | 54 |
| 4.7.1 Northbridge Configuration..... | 55 |
| 4.7.2 Southbridge Configuration..... | 56 |
| 4.8 EXIT..... | 57 |
| A ONE KEY RECOVERY..... | 59 |
| A.1 ONE KEY RECOVERY INTRODUCTION..... | 60 |
| A.1.1 System Requirement..... | 60 |
| A.1.2 Supported Operating System..... | 61 |
| A.2 INITIAL SETUP PROCEDURE FOR WINDOWS..... | 62 |
| A.2.1 Hardware and BIOS Setup..... | 63 |

| | |
|---|-----------|
| A.2.2 Create Partitions | 63 |
| A.2.3 Build-up Recovery Partition..... | 66 |
| A.2.4 Create Factory Default Image..... | 68 |
| A.3 INITIAL SETUP PROCEDURE FOR LINUX | 73 |
| A.4 RECOVERY TOOL FUNCTIONS | 77 |
| A.4.1 Factory Restore | 78 |
| A.4.2 Backup System..... | 79 |
| A.4.3 Restore Your Last Backup..... | 80 |
| A.4.4 Manual..... | 81 |
| B SAFETY PRECAUTIONS | 82 |
| B.1 SAFETY PRECAUTIONS..... | 83 |
| B.1.1 General Safety Precautions | 83 |
| B.1.2 Anti-static Precautions | 84 |
| B.2 MAINTENANCE AND CLEANING PRECAUTIONS | 84 |
| B.2.1 Maintenance and Cleaning..... | 84 |
| B.2.2 Cleaning Tools..... | 85 |
| C HAZARDOUS MATERIALS DISCLOSURE | 86 |
| C.1 HAZARDOUS MATERIALS DISCLOSURE TABLE FOR IPB PRODUCTS CERTIFIED AS ROHS COMPLIANT UNDER 2002/95/EC WITHOUT MERCURY | 87 |

List of Figures

| | |
|---|----|
| Figure 1-1: TANK-GM45 | 2 |
| Figure 1-2: TANK-GM45 Peripheral Connectors | 5 |
| Figure 1-3: Physical Dimensions (millimeters)..... | 6 |
| Figure 3-1: Bottom Panel Retention Screws (Rear Panel) | 11 |
| Figure 3-2: Bottom Panel Retention Screws (Bottom Panel)..... | 12 |
| Figure 3-3: Open the Bottom Panel | 12 |
| Figure 3-4: HDD Bracket Retention Screws..... | 13 |
| Figure 3-5: HDD Retention Screws | 13 |
| Figure 3-6: HDD Installation..... | 14 |
| Figure 3-7: Peripheral Connectors (Rear) | 16 |
| Figure 3-8: LAN Connection | 17 |
| Figure 3-9: RJ-45 Ethernet Connector..... | 17 |
| Figure 3-10: PS/2 Keyboard/Mouse Connector | 18 |
| Figure 3-11: Power Input Connector..... | 19 |
| Figure 3-12: Remote Control Terminal Block Pinout Location..... | 19 |
| Figure 3-13: Serial Device Connector..... | 20 |
| Figure 3-14: Serial Port Pinout Location | 21 |
| Figure 3-15: Serial Port Pinout Location | 22 |
| Figure 3-16: USB Device Connection | 23 |
| Figure 3-17: VGA Connector | 24 |
| Figure 3-18: VGA Connector | 24 |
| Figure 3-19: AT/ATX Switch..... | 25 |
| Figure A-1: Recovery Tool Setup Menu | 64 |
| Figure A-2: Command Mode..... | 64 |
| Figure A-3: Partition Creation Commands..... | 65 |
| Figure A-4: System Configuration for Windows | 66 |
| Figure A-5: Build-up Recovery Partition | 67 |
| Figure A-6: Press any key to continue | 67 |
| Figure A-7: Press F3 to Boot into Recovery Mode..... | 68 |
| Figure A-8: Recovery Tool Menu | 68 |

| | |
|--|-----------|
| Figure A-9: About Symantec Ghost Window | 69 |
| Figure A-10: Symantec Ghost Path | 69 |
| Figure A-11: Select a Local Source Drive | 70 |
| Figure A-12: Select a Source Partition from Basic Drive | 70 |
| Figure A-13: File Name to Copy Image to | 71 |
| Figure A-14: Compress Image | 71 |
| Figure A-15: Image Creation Confirmation | 72 |
| Figure A-16: Image Creation Complete | 72 |
| Figure A-17: Image Creation Complete | 72 |
| Figure A-18: Press Any Key to Continue | 73 |
| Figure A-19: Partitions for Linux | 74 |
| Figure A-20: System Configuration for Linux | 75 |
| Figure A-21: Access menu.lst in Linux (Text Mode) | 75 |
| Figure A-22: Recovery Tool Menu | 76 |
| Figure A-23: Recovery Tool Main Menu | 77 |
| Figure A-24: Restore Factory Default | 78 |
| Figure A-25: Recovery Complete Window | 79 |
| Figure A-26: Backup System | 79 |
| Figure A-27: System Backup Complete Window | 80 |
| Figure A-28: Restore Backup | 80 |
| Figure A-29: Restore System Backup Complete Window | 81 |
| Figure A-30: Symantec Ghost Window | 81 |

List of Tables

| | |
|---|----|
| Table 1-1: TANK-GM45 Model Variations | 2 |
| Table 1-1: Technical Specifications..... | 4 |
| Table 2-1: Package List Contents | 9 |
| Table 3-1: COM3 RS-422/485 Setup | 15 |
| Table 3-2: COM3 RS-422/485 Setup | 15 |
| Table 3-3: COM3 RS-422/485 Setup | 15 |
| Table 3-4: LAN Pinouts | 17 |
| Table 3-5: RJ-45 Ethernet Connector LEDs | 18 |
| Table 3-6: Power Input Pinouts | 19 |
| Table 3-7: Remote Control Terminal Block Pinouts..... | 19 |
| Table 3-8: COM1 Serial Port Pinouts | 21 |
| Table 3-9: RS-422 Pinouts | 21 |
| Table 3-10: RS-485 Pinouts | 22 |
| Table 3-11: USB Port Pinouts..... | 23 |
| Table 3-12: VGA Connector Pinouts..... | 25 |
| Table 4-1: BIOS Navigation Keys | 28 |

Chapter

1

Introduction

1.1 Overview



Figure 1-1: TANK-GM45

The TANK-GM45 Series embedded system is a fanless system for wide range temperature environments. It is powered by the Intel® 45nm Core™2 Duo processor, uses the Intel® GM45 chipset and has 2.0 GB of DDR2 memory. The TANK-GM45B in this series is preinstalled with a 32 GB SATA Solid State Disk (SSD) with up to 3Gb/s data transfer rate.

1.2 Model Variations

The model variations of the TANK-GM45 Series are listed below.

| Model No. | CPU | Preinstalled SSD |
|----------------------|----------------------------------|------------------|
| TANK-GM45A-R10/P8600 | 2.4 GHz Intel® Core™2 Duo P8600 | -- |
| TANK-GM45A-R10/CM575 | 2.0 GHz Intel® Celeron 575 | -- |
| TANK-GM45B-T9400 | 2.53 GHz Intel® Core™2 Duo T9400 | 32 GB SATA SSD |
| TANK-GM45B-P8600 | 2.4 GHz Intel® Core™2 Duo P8600 | 32 GB SATA SSD |
| TANK-GM45B-575 | 2.0 GHz Intel® Celeron 575 | 32 GB SATA SSD |

Table 1-1: TANK-GM45 Model Variations

1.3 Benefits

Some of the TANK-GM45 benefits include:

- Wide range storage temperature for various environments.
- Less downtime from overheating because there are not fans to fail

TANK-GM45 Embedded System

- Cost savings with low power consumption

1.4 Features

The TANK-GM45 features are listed below:

- Intel® 45nm Core™2 Duo processor
- 2.0 GB of DDR2 SDRAM SO-DIMM preinstalled
- One GPIO block terminal for remote control
- Two Gigabit Ethernet ports
- Four USB 2.0 ports
- One RS-232 isolated serial port
- One RS-422/485 isolated serial port
- One VGA port
- AT/ATX power mode supported
- RoHS compliant

1.5 Technical Specifications

The TANK-GM45 technical specifications are listed in **Table 1-2**.

| Specifications | |
|---------------------|---|
| System | |
| Supported CPU | 2.53 GHz Intel® Core™2 Duo T9400 CPU, 2.4 GHz Intel® Core™2 Duo P8600 CPU or 2.0 GHz Intel® Celeron 575 CPU |
| Memory | 2.0 GB of DDR2 SO-DIMM preinstalled |
| Real-time Clock | Battery backup RTC |
| Watchdog Timer | Software programmable supports 1~255 sec. system reset |
| Ethernet Controller | One Intel® 82574L PCIe GbE Controller One Intel® WG82567LM GbE PHY |
| Supported OS | Windows® XP or Linux |
| I/O and Indicators | |
| Ethernet | 2 x 10/100/1000 Mb/s |

| Specifications | |
|-------------------------------------|---|
| Keyboard/Mouse | One PS/2 keyboard/mouse connector |
| Serial Ports | 1 x RS-232 (isolated) 1 x RS-422/485 (isolated) |
| USB Interfaces | 4 x USB 2.0 ports |
| VGA | One VGA port |
| GPIO | One 2-pin terminal block for remote control |
| LED Indicator | One power LED (green) One HDD LED (red) |
| Storage | |
| SDD | Support one 2.5" SATA HDD (TANK-GM45B is preinstalled with one 32 GB SATA 3Gb/s SSD) |
| Power | |
| Power Supply | +12 V DC |
| Power Consumption | 45 W |
| Power Switch | One power switch |
| Power Mode | AT or ATX power mode (selectable by AT/ATX switch) |
| Environmental and Mechanical | |
| Operating Temperature | -20°C~70°C |
| Storage Temperature | -25°C~75°C |
| Color | Silver |
| Physical Dimensions | 310 mm x 200 mm x 55 mm (W x D x H) |

Table 1-2: Technical Specifications

TANK-GM45 Embedded System

1.6 Connector Panel

All external peripheral interface connectors are located on the front panel of the TANK-GM45 . The peripheral interface connectors are shown in **Figure 1-2**.

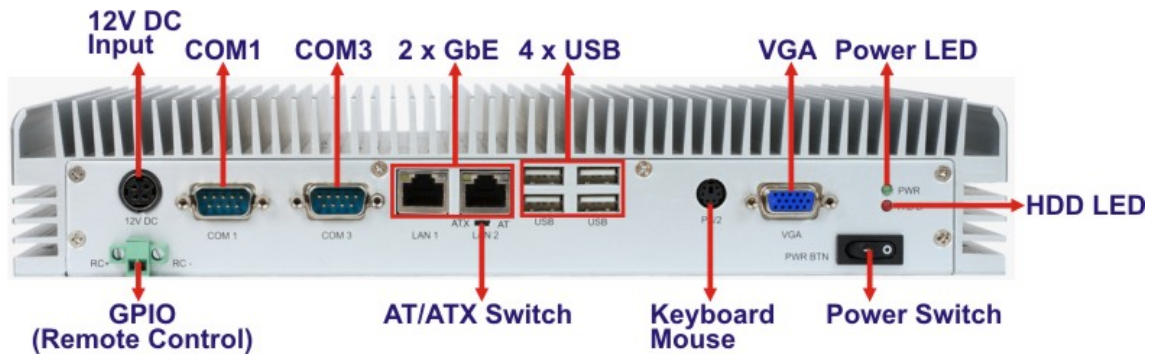

Figure 1-2: TANK-GM45 Peripheral Connectors

Connectors and buttons on the rear panel include the following.

- 1 x 12 V DC power input
- 1 x Power switch
- 1 x VGA output
- 1 x RS-232 port isolated serial port
- 1 x RS-422/485 isolated serial port
- 4 x USB ports
- 2 x Gigabit Ethernet ports
- 1 x GPIO terminal block for remote control
- 1 x PS/2 keyboard/mouse connector
- 1 x Power LED
- 1 x HDD LED
- 1 x AT/ATX power switch

1.7 Dimensions

The physical dimensions are shown below:

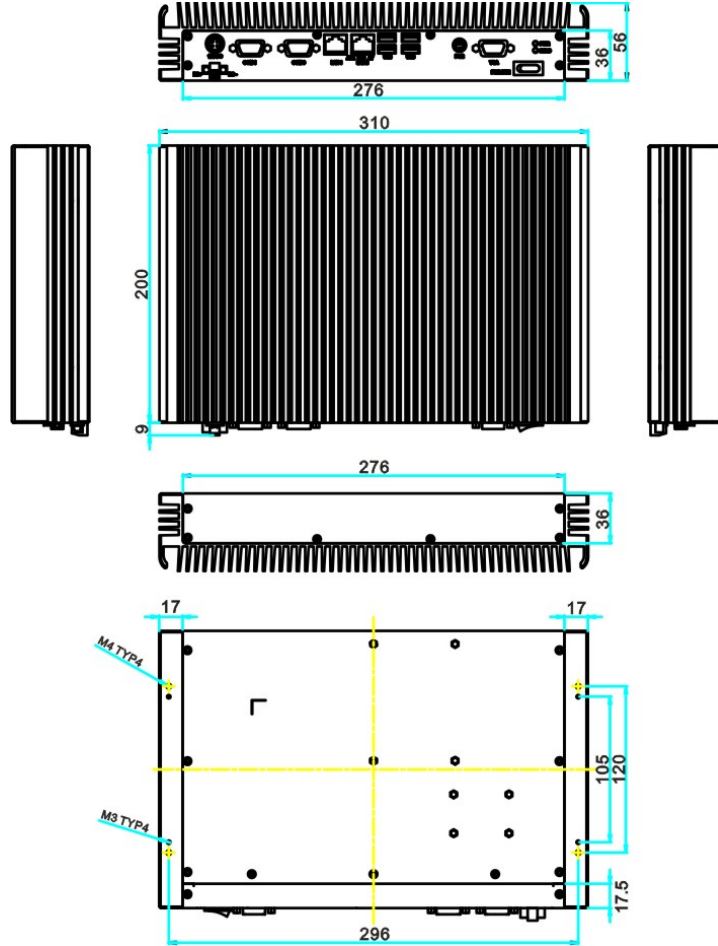

Figure 1-3: Physical Dimensions (millimeters)

Chapter

2

Unpacking

2.1 Anti-static Precautions



WARNING:

Failure to take ESD precautions during installation may result in permanent damage to the TANK-GM45 and severe injury to the user.

Electrostatic discharge (ESD) can cause serious damage to electronic components, including the TANK-GM45. Dry climates are especially susceptible to ESD. It is therefore critical that whenever the TANK-GM45 or any other electrical component is handled, the following anti-static precautions are strictly adhered to.

- **Wear an anti-static wristband:** Wearing a simple anti-static wristband can help to prevent ESD from damaging the board.
- **Self-grounding:** Before handling the board touch any grounded conducting material. During the time the board is handled, frequently touch any conducting materials that are connected to the ground.
- **Use an anti-static pad:** When configuring the TANK-GM45, place it on an anti-static pad. This reduces the possibility of ESD damaging the TANK-GM45.

2.2 Unpacking Precautions

When the TANK-GM45 is unpacked, please do the following:

- Follow the anti-static precautions outlined in **Section 2.1**.
- Make sure the packing box is facing upwards so the TANK-GM45 does not fall out of the box.
- Make sure all the components shown in **Section 2.3** are present.

TANK-GM45 Embedded System

2.3 Unpacking Checklist



NOTE:

If some of the components listed in the checklist below are missing, please do not proceed with the installation. Contact the IEI reseller or vendor you purchased the TANK-GM45 from or contact an IEI sales representative directly. To contact an IEI sales representative, please send an email to sales@iei.com.tw.

The TANK-GM45 is shipped with the following components:





| Quantity | Item and Part Number | Image |
|----------|---|--|
| 1 | TANK-GM45 |  |
| 1 | DC input cable (with terminal block) (TANK-GM45A only) |  |
| 1 | Power adapter (TANK-GM45B only) |  |
| 1 | User manual and driver CD |  |

Table 2-1: Package List Contents



Chapter

3

Installation

TANK-GM45 Embedded System

3.1 Installation Precautions

During installation, be aware of the precautions below:

- **Read the user manual:** The user manual provides a complete description of the TANK-GM45, installation instructions and configuration options.
- **DANGER! Disconnect Power:** Power to the TANK-GM45 must be disconnected during the installation process, or before any attempt is made to access the rear panel. Electric shock and personal injury might occur if the rear panel of the TANK-GM45 is opened while the power cord is still connected to an electrical outlet.
- **Qualified Personnel:** The TANK-GM45 must be installed and operated only by trained and qualified personnel. Maintenance, upgrades, or repairs may only be carried out by qualified personnel who are familiar with the associated dangers.
- **Air Circulation:** Make sure there is sufficient air circulation when installing the TANK-GM45. The TANK-GM45's cooling vents must not be obstructed by any objects. Blocking the vents can cause overheating of the TANK-GM45. Leave at least 5 cm of clearance around the TANK-GM45 to prevent overheating.
- **Grounding:** The TANK-GM45 should be properly grounded. The voltage feeds must not be overloaded. Adjust the cabling and provide external overcharge protection per the electrical values indicated on the label attached to the back of the TANK-GM45.

3.2 Hard Disk Drive (HDD) Installation

To install the hard drive, please follow the steps below:

- Step 1:** Remove the bottom panel by removing 15 retention screws from the rear panel (Figure 3-1) and the bottom panel (Figure 3-2).



Figure 3-1: Bottom Panel Retention Screws (Rear Panel)



Figure 3-2: Bottom Panel Retention Screws (Bottom Panel)

Step 2: To prevent the internal SATA cable from damage, please open the bottom panel as shown below.



Figure 3-3: Open the Bottom Panel

Step 3: Remove the four HDD bracket retention screws (**Figure 3-4**) and lift the HDD brackets out of the TANK-GM45.

TANK-GM45 Embedded System

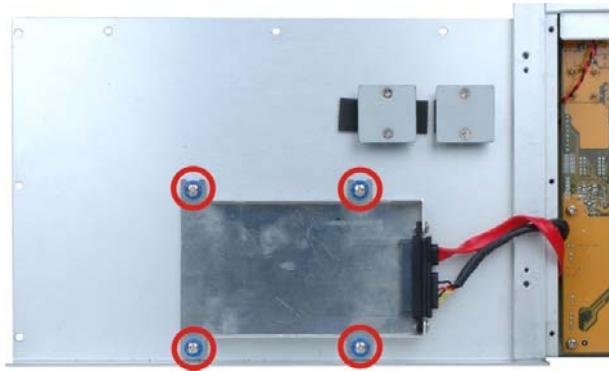

Figure 3-4: HDD Bracket Retention Screws

Step 4: Attach the HDD bracket to the HDD. Slide the HDD to connect the HDD to the SATA connector. Secure the HDD with the HDD bracket by four retention screws (Figure 3-5).

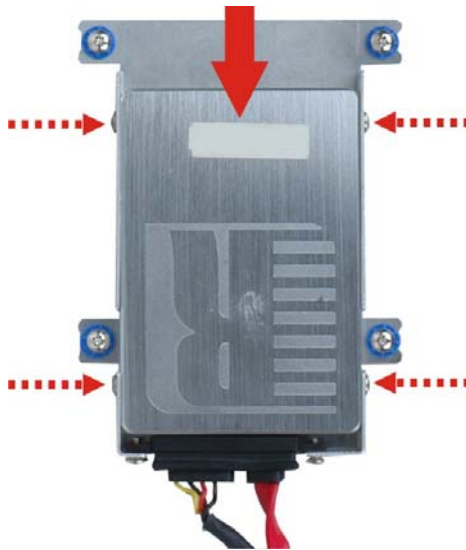

Figure 3-5: HDD Retention Screws

Step 5: Install the HDD bracket in the same position it was before.

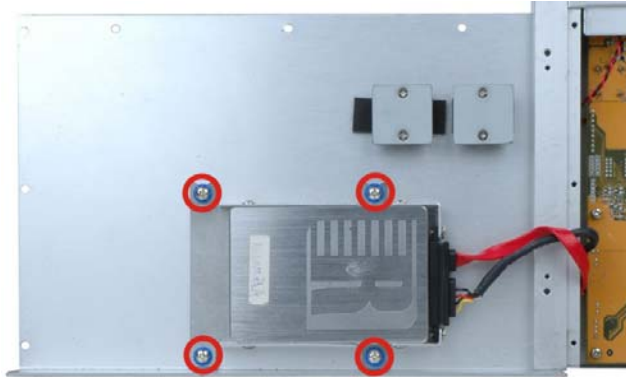

Figure 3-6: HDD Installation

Step 6: Reinstall the bottom panel.

3.3 Jumper Settings



NOTE:

A jumper is a metal bridge used to close an electrical circuit. It consists of two or three metal pins and a small metal clip (often protected by a plastic cover) that slides over the pins to connect them. To CLOSE/SHORT a jumper means connecting the pins of the jumper with the plastic clip and to OPEN a jumper means removing the plastic clip from a jumper.

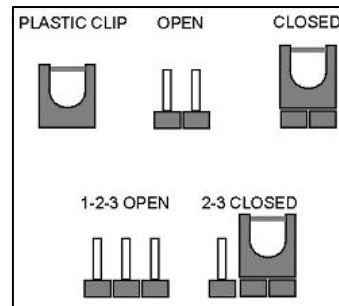

To access jumper, please remove the bottom panel (refer to **Section 3.2**), 12 motherboard retention screws and six front panel retention screws. The motherboard jumper is listed below.

- COM3 RS-422/485 selection

TANK-GM45 Embedded System

3.3.1 COM3 RS-422/485 Setup

- Jumper Label:** J5, J9 and J10
- Jumper Type:** Pin headers
- Jumper Settings:** See Table 3-1, Table 3-2 and Table 3-3

This serial port can be set to use RS-422 or RS-485 communication methods. Set all the jumpers to the same settings.

| J5 | Description |
|----------------------|----------------------|
| 2-3, 5-6, 8-9, 11-12 | RS-422/485 (Default) |

Table 3-1: COM3 RS-422/485 Setup

| J9 | Description |
|-----|------------------|
| 3-4 | RS-422 (Default) |
| 5-6 | RS-485 |

Table 3-2: COM3 RS-422/485 Setup

| J10 | Description |
|----------|------------------|
| 1-3, 2-4 | RS-422 (Default) |
| 3-5, 4-6 | RS-485 |

Table 3-3: COM3 RS-422/485 Setup

3.4 External Peripheral Interface Connectors

The TANK-GM45 has the following connectors. Detailed descriptions of the connectors can be found in the subsections below.

- Ethernet
- Keyboard/Mouse
- Power button
- Power input
- GPIO for remote control
- RS-232

- RS-422/485
- USB
- VGA

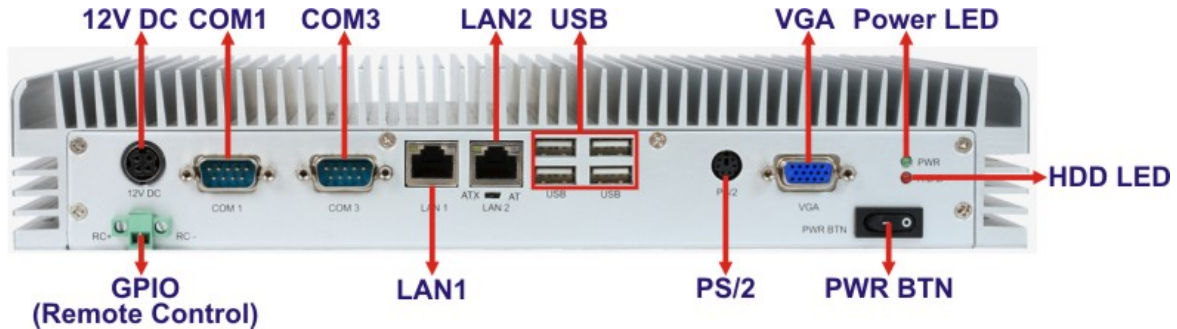

Figure 3-7: Peripheral Connectors (Rear)

3.4.1 LAN Connectors

- CN Label:** LAN1 and LAN2
- CN Type:** RJ-45
- CN Location:** See **Figure 3-7**
- CN Pinouts:** See **Table 3-4**

The LAN connectors allow connection to an external network.

Step 1: **Locate the RJ-45 connectors.** The locations of the RJ-45 connectors are shown above.

Step 2: **Align the connectors.** Align the RJ-45 connector on the LAN cable with one of the RJ-45 connectors on the TANK-GM45. See **Figure 3-8**.

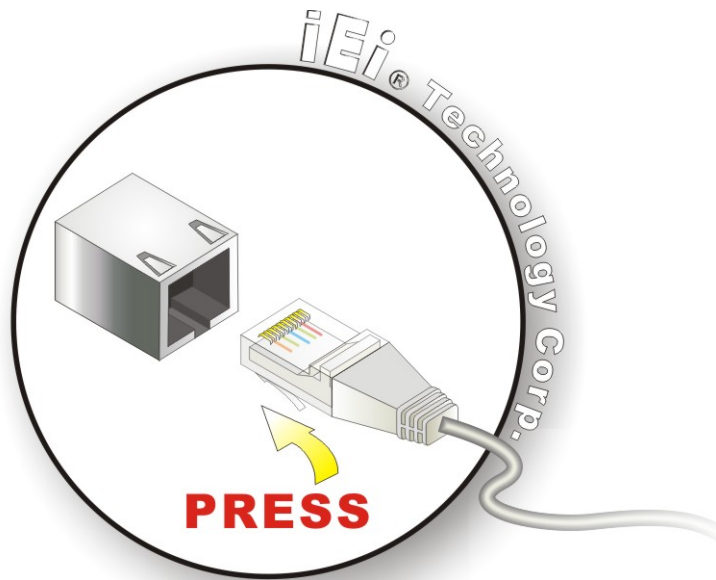

Figure 3-8: LAN Connection

Step 3: Insert the LAN cable RJ-45 connector. Once aligned, gently insert the LAN cable RJ-45 connector into the on-board RJ-45 connector.

| Pin | Description | Pin | Description |
|-----|-------------|-----|-------------|
| 1 | TRD1P0 | 5 | TRD1P2 |
| 2 | TRD1N0 | 6 | TRD1N2 |
| 3. | TRD1P1 | 7 | TRD1P3 |
| 4. | TRD1N1 | 8 | TRD1N3 |

Table 3-4: LAN Pinouts



Figure 3-9: RJ-45 Ethernet Connector

The RJ-45 Ethernet connector has two status LEDs, one green and one yellow. The green LED indicates activity on the port and the yellow LED indicates the port is linked. See Table 3-5.

| Activity/Link LED | | Speed LED | |
|-------------------|----------------|-----------|---------------------|
| STATUS | DESCRIPTION | STATUS | DESCRIPTION |
| Off | No link | Off | 10 Mbps connection |
| Yellow | Linked | Green | 100 Mbps connection |
| Blinking | TX/RX activity | Orange | 1 Gbps connection |

Table 3-5: RJ-45 Ethernet Connector LEDs

3.4.2 Keyboard/Mouse Connector

- CN Label:** PS/2
- CN Type:** PS/2
- CN Location:** See **Figure 3-7**
- CN Location:** See **Figure 3-10**

The PS/2 connector connects to a keyboard and a mouse.

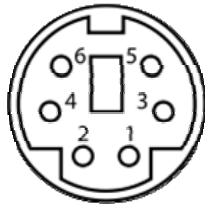

Figure 3-10: PS/2 Keyboard/Mouse Connector

3.4.3 Power Input

- CN Label:** 12VDC
- CN Type:** 4-pin DIN connector
- CN Location:** See **Figure 3-7**
- CN Pinouts:** See **Figure 3-11**

The power connector connects to the 12 V DC power adapter.



Figure 3-11: Power Input Connector

| Pin | Description | Pin | Description |
|-----|-------------|-----|-------------|
| 1 | +12V | 3 | +12V |
| 2 | GND | 4 | GND |

Table 3-6: Power Input Pinouts

3.4.4 Remote Control Connector

- CN Label:** GPIO (Remote Control)
- CN Type:** 2-pin terminal block
- CN Location:** See Figure 3-7
- CN Pinouts:** See Table 3-7 and Figure 3-12

The GPIO terminal block connects to a remote control device. Users can control the system power on/off by inputting high or low voltage into the terminal block.

- **Turn off** the system: **more than 1 V** input
- **Turn on** the system: **less than 0.5 V** input

| Pin | Description |
|-----|-------------|
| 1 | RC+ |
| 2 | RC- |

Table 3-7: Remote Control Terminal Block Pinouts

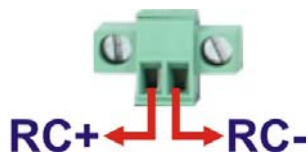

Figure 3-12: Remote Control Terminal Block Pinout Location

3.4.5 RS-232 Serial Port Connector

| | |
|---------------------|---|
| CN Label: | COM1 |
| CN Type: | DB-9 connectors |
| CN Location: | See Figure 3-7 |
| CN Pinouts: | See Table 3-8 and Figure 3-14 |

RS-232 serial port devices can be attached to the DB-9 ports on the rear panel.

Step 1: **Locate the DB-9 connector.** The location of the DB-9 connector is shown in **Figure 3-7**.

Step 2: **Insert the serial connector.** Insert the DB-9 connector of a serial device into the DB-9 connector on the external peripheral interface. See **Figure 3-13**.

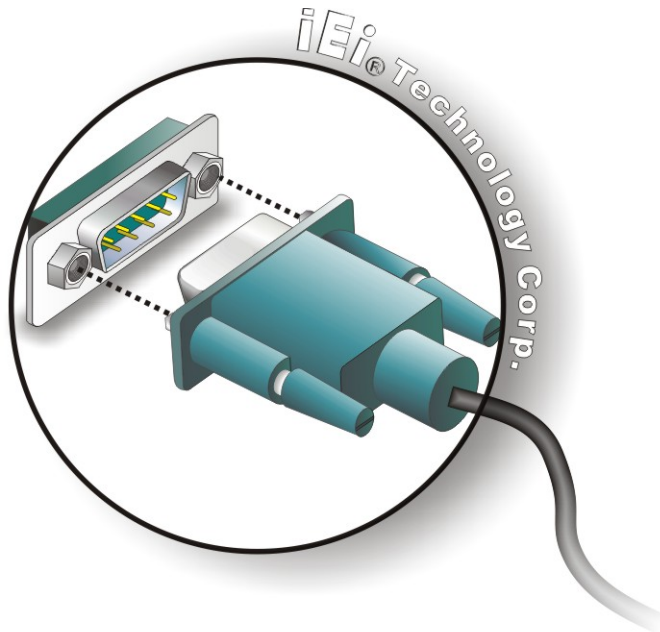

Figure 3-13: Serial Device Connector

Step 3: **Secure the connector.** Secure the serial device connector to the external interface by tightening the two retention screws on either side of the connector.

TANK-GM45 Embedded System

| Pin | Description | Pin | Description |
|-----|-------------|-----|-------------|
| 1 | DCD | 6 | DSR |
| 2 | RX | 7 | RTS |
| 3 | TX | 8 | CTS |
| 4 | DTR | 9 | RI |
| 5 | GND | | |

Table 3-8: COM1 Serial Port Pinouts

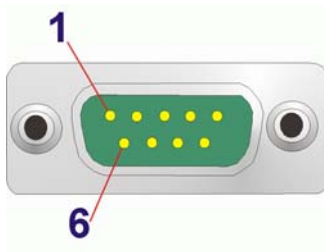

Figure 3-14: Serial Port Pinout Location

3.4.6 RS-422/485 Serial Port Connector

- CN Label:** COM3
- CN Type:** DB-9 connectors
- CN Location:** See **Figure 3-7**
- CN Pinouts:** See **Table 3-9** and **Table 3-10**

RS-422/485 serial port devices can be attached to the DB-9 ports on the rear panel. The COM3 serial port is a RS-422 serial port by default. To change to RS-485, please refer to the jumper setting (**Section 3.3.1**).

| COM 3 | RS-422 Description |
|-------|--------------------|
| Pin 1 | TX- |
| Pin 2 | TX+ |
| Pin 6 | RX- |
| Pin 7 | RX+ |

Table 3-9: RS-422 Pinouts

| COM 3 | RS-485 Description |
|-------|--------------------|
| Pin 1 | Data- |
| Pin 2 | Data+ |

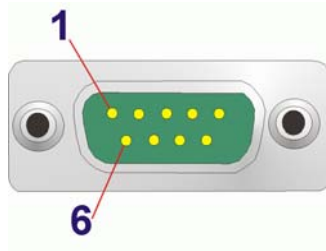
Table 3-10: RS-485 Pinouts

Figure 3-15: Serial Port Pinout Location

3.4.7 USB Connector

- CN Label:** USB
- CN Type:** USB port
- CN Location:** See **Figure 3-7**
- CN Pinouts:** See **Table 3-11**

The USB ports are for attaching USB peripheral devices to the system.

Step 1: **Located the USB connectors.** The locations of the USB connectors are shown in **Chapter 1**.

Step 2: **Align the connectors.** Align the USB device connector with one of the connectors. See **Figure 3-16**.

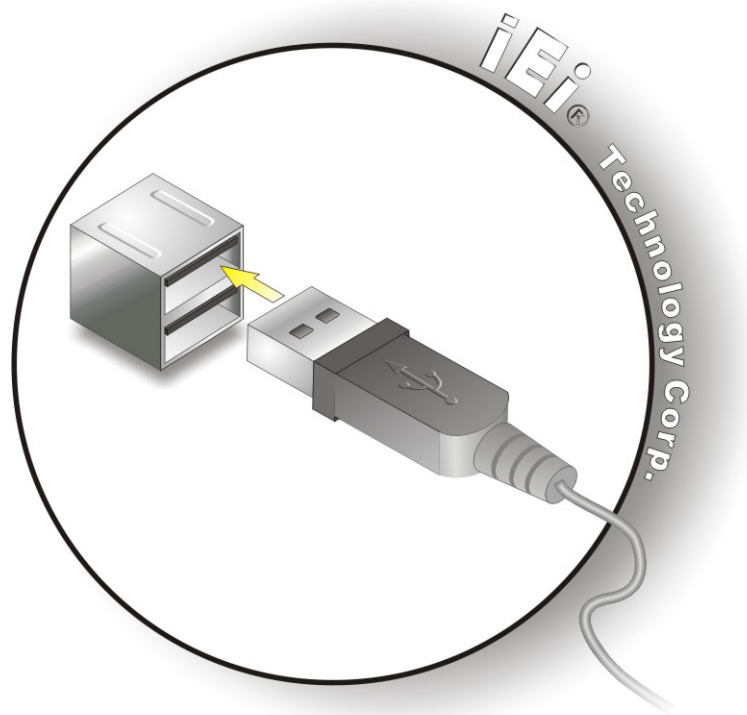

Figure 3-16: USB Device Connection

Step 3: Insert the device connector. Once aligned, gently insert the USB device connector into the on-board connector.

| Pin | Description | Pin | Description |
|-----|-------------|-----|-------------|
| 1 | VCC | 5 | VCC |
| 2 | DATA- | 6 | DATA- |
| 3 | DATA+ | 7 | DATA+ |
| 4 | GROUND | 8 | GROUND |

Table 3-11: USB Port Pinouts

3.4.8 VGA Connector

- CN Label:** VGA
- CN Type:** 15-pin Female
- CN Location:** See Figure 3-7
- CN Pinouts:** See Figure 3-18 and Table 3-12

The VGA connector connects to a monitor that accepts VGA video input.

- Step 1:** **Locate the female DB-15 connector.** The location of the female DB-15 connector is shown in **Chapter 3**.
- Step 2:** **Align the VGA connector.** Align the male DB-15 connector on the VGA screen cable with the female DB-15 connector on the external peripheral interface.
- Step 3:** **Insert the VGA connector** Once the connectors are properly aligned with the insert the male connector from the VGA screen into the female connector on the TANK-GM45. See **Figure 3-17**.

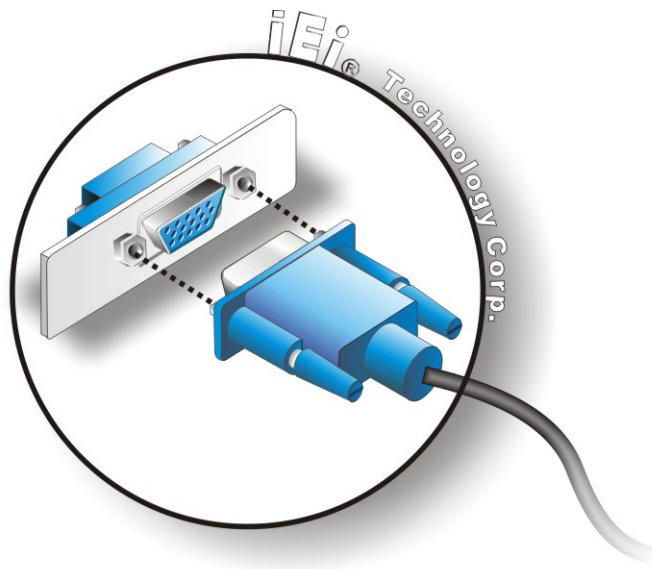

Figure 3-17: VGA Connector

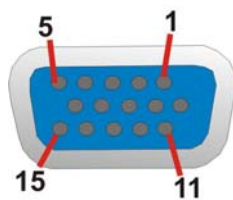

Figure 3-18: VGA Connector

TANK-GM45 Embedded System

| Pin | Description | Pin | Description |
|-----|-------------|-----|-------------|
| 1 | RED | 2 | GREEN |
| 3 | BLUE | 4 | NC |
| 5 | GND | 6 | GND |
| 7 | GND | 8 | GND |
| 9 | VCC / NC | 10 | GND |
| 11 | NC | 12 | DDC DAT |
| 13 | HSYNC | 14 | VSYNC |
| 15 | DDCCLK | | |

Table 3-12: VGA Connector Pinouts

3.4.9 AT/ATX Power Mode Selection

The TANK-GM45 supports AT and ATX power modes. The setting can be made through the AT/ATX switch on the external peripheral interface panel as shown below.



Figure 3-19: AT/ATX Switch



Chapter

4

BIOS

4.1 Introduction

The BIOS is programmed onto the BIOS chip. The BIOS setup program allows changes to certain system settings. This chapter outlines the options that can be changed.

4.1.1 Starting Setup

The AMI BIOS is activated when the computer is turned on. The setup program can be activated in one of two ways.

1. Press the **DELETE** key as soon as the system is turned on or
2. Press the **DELETE** key when the “**Press Del to enter SETUP**” message appears on the screen.

If the message disappears before the **DELETE** key is pressed, restart the computer and try again.

4.1.2 Using Setup

Use the arrow keys to highlight items, press **ENTER** to select, use the PageUp and PageDown keys to change entries, press **F1** for help and press **Esc** to quit. Navigation keys are shown in.

| Key | Function |
|-------------|--|
| Up arrow | Move to previous item |
| Down arrow | Move to next item |
| Left arrow | Move to the item on the left hand side |
| Right arrow | Move to the item on the right hand side |
| Esc key | Main Menu – Quit and not save changes into CMOS Status Page Setup Menu and Option Page Setup Menu -- Exit current page and return to Main Menu |
| Page Up key | Increase the numeric value or make changes |
| Page Dn key | Decrease the numeric value or make changes |
| F1 key | General help, only for Status Page Setup Menu and Option Page Setup Menu |

| Key | Function |
|------------|--|
| F2 /F3 key | Change color from total 16 colors. F2 to select color forward. |
| F10 key | Save all the CMOS changes, only for Main Menu |

Table 4-1: BIOS Navigation Keys

4.1.3 Getting Help

When **F1** is pressed a small help window describing the appropriate keys to use and the possible selections for the highlighted item appears. To exit the Help Window press **Esc** or the **F1** key again.

4.1.4 Unable to Reboot After Configuration Changes

If the computer cannot boot after changes to the system configuration is made, CMOS defaults. Use the jumper described in Chapter 2.

4.1.5 BIOS Menu Bar

The **menu bar** on top of the BIOS screen has the following main items:

- Main – Changes the basic system configuration.
- Advanced – Changes the advanced system settings.
- PCIPnP – Changes the advanced PCI/PnP Settings
- Boot – Changes the system boot configuration.
- Security – Sets User and Supervisor Passwords.
- Chipset – Changes the chipset settings.
- Exit – Selects exit options and loads default settings

The following sections completely describe the configuration options found in the menu items at the top of the BIOS screen and listed above.

TANK-GM45 Embedded System

4.2 Main

The **Main** BIOS menu (BIOS Menu 1) appears when the **BIOS Setup** program is entered. The **Main** menu gives an overview of the basic system information.

```

BIOS SETUP UTILITY
Main  Advanced  PCIPNP  Boot  Security  Chipset  Exit

System Overview
-----
AMIBIOS
Version      :08.00.15
Build Date   :01/15/10
ID:          :SA11MR13

Processor
Intel(R) Core(TM)2 Duo CPU   P8600 @ 2.4GHz
Speed        :2400MHz
Count        :1

System Memory
Size         :2013MB

System Time   [16:38:10]
System Time   [Fri 02/15/2010]

Use [ENTER], [TAB] or [SHIFT-TAB] to select a field.
Use [+] or [-] to configure system time.

<=> Select Screen
↑↓ Select Item
Enter Go to SubScreen
F1 General Help
F10 Save and Exit
ESC Exit

v02.61 ©Copyright 1985-2006, American Megatrends, Inc.

```

BIOS Menu 1: Main

- **System Overview**

The **System Overview** lists a brief summary of different system components. The fields in **System Overview** cannot be changed. The items shown in the system overview include:

- AMI BIOS: Displays auto-detected BIOS information
 - **Version:** Current BIOS version
 - **Build Date:** Date the current BIOS version was made
 - **ID:** Installed BIOS ID
- Processor: Displays auto-detected CPU specifications
 - **Type:** Names the currently installed processor
 - **Speed:** Lists the processor speed
 - **Count:** The number of CPUs on the motherboard
- System Memory: Displays the auto-detected system memory.
 - **Size:** Lists memory size

The System Overview field also has two user configurable fields:

- **System Time [xx:xx:xx]**

Use the **System Time** option to set the system time. Manually enter the hours, minutes and seconds.

- **System Date [xx/xx/xx]**

Use the **System Date** option to set the system date. Manually enter the day, month and year.

4.3 Advanced

Use the **Advanced** menu (BIOS Menu 2) to configure the CPU and peripheral devices through the following sub-menus:



WARNING!

Setting the wrong values in the sections below may cause the system to malfunction. Make sure that the settings made are compatible with the hardware.

- CPU Configuration (see **Section 4.3.1**)
- IDE Configuration (see **Section 4.3.2**)
- Super IO Configuration (see **Section 4.3.3**)
- Hardware Health Configuration (see **Section 4.3.4**)
- AHCI Configuration (see **Section 4.3.5**)
- Remote Access Configuration (see **Section 4.3.6**)
- USB Configuration (see **Section 4.3.7**)
- Power Configuration (see **Section 4.3.8**)

TANK-GM45 Embedded System

```

BIOS SETUP UTILITY
Main  Advanced  PCIPNP  Boot  Security  Chipset  Exit
-----
Advanced Settings                                Configure CPU
-----
WARNING: Setting wrong values in below sections may cause
system to malfunction

> CPU Configuration
> IDE Configuration
> SuperIO Configuration
> Hardware Health Configuration
> AHCI Configuration
> Remote Access Configuration
> USB Configuration
> Power Configuration

                                  ←→  Select Screen
                                  ↑↓  Select Item
                                  Enter Go to SubScreen
                                  F1   General Help
                                  F10  Save and Exit
                                  ESC  Exit

v02.61 ©Copyright 1985-2006, American Megatrends, Inc.

```

BIOS Menu 2: Advanced

4.3.1 CPU Configuration

Use the **CPU Configuration** menu (BIOS Menu 3) to view detailed CPU specifications and configure the CPU.

```

BIOS SETUP UTILITY
Main  Advanced  PCIPNP  Boot  Security  Chipset  Exit
-----
Configure advanced CPU settings
Module Version:3F.15
-----
Manufacturer: Intel
Intel(R) Core(TM)2 Duo CPU   P8600 @ 2.4GHz
Frequency: 2.4GHz
FSB Speed: 1066MHz
Cache L1: 64 KB
Cache L2: 3072 KB
Ratio Actual Value:8.5

                                  ←→  Select Screen
                                  ↑↓  Select Item
                                  Enter Go to SubScreen
                                  F1   General Help
                                  F10  Save and Exit
                                  ESC  Exit

v02.61 ©Copyright 1985-2006, American Megatrends, Inc.

```

BIOS Menu 3: CPU Configuration

The CPU Configuration menu (BIOS Menu 3) lists the following CPU details:

- Manufacturer: Lists the name of the CPU manufacturer
- Brand String: Lists the brand name of the CPU being used

- Frequency: Lists the CPU processing speed
- FSB Speed: Lists the FSB speed
- Cache L1: Lists the CPU L1 cache size
- Cache L2: Lists the CPU L2 cache size

4.3.2 IDE Configuration

Use the **IDE Configuration** menu (BIOS Menu 4) to change and/or set the configuration of the IDE devices installed in the system.

```

BIOS SETUP UTILITY
Main  Advanced  PCIPNP  Boot  Security  Chipset  Exit
-----
IDE Configuration                               Disabled
                                                Compatible
SATA#1 Configuration                            [Compatible]
Configure SATA#1 as                             [IDE]                               Enhanced

> Primary IDE Master                           : [Not Detected]
> Primary IDE Slave                            : [Not Detected]
> Secondary IDE Master                         : [Not Detected]
> Secondary IDE Slave                          : [Not Detected]
> Third IDE Master                             : [Not Detected]

                                                ←→  Select Screen
                                                ↑↓  Select Item
Enter  Go to SubScreen
F1    General Help
F10   Save and Exit
ESC   Exit

v02.61 ©Copyright 1985-2006, American Megatrends, Inc.

```

BIOS Menu 4: IDE Configuration

- **Parallel ATA IDE devices**

Displays the settings for all the IDE devices. The devices listed below are available.

- Primary IDE Master
- Primary IDE Slave
- Secondary IDE Master
- Secondary IDE Slave
- Third IDE Master

TANK-GM45 Embedded System

- **SATA#1 Configuration [Compatible]**

Use the **SATA#1 Configuration** option to configure the ATA/IDE controller.

- ➔ **Disabled** Disables the on-board ATA/IDE controller.
- ➔ **Compatible DEFAULT** Configures the on-board ATA/IDE controller to be in compatible mode. In this mode, a SATA channel will replace one of the IDE channels. This mode supports up to 4 storage devices.
- ➔ **Enhanced** Configures the on-board ATA/IDE controller to be in Enhanced mode. In this mode, IDE channels and SATA channels are separated. This mode supports up to 6 storage devices. Some legacy OS do not support this mode.

- **Configure SATA#1 as [IDE]**

Use the **Configure SATA#1 as** option to configure SATA devices as normal IDE devices.

- ➔ **IDE DEFAULT** Configures SATA devices as normal IDE device.
- ➔ **AHCI** Configures SATA devices as AHCI device.

4.3.2.1 SATA Channel

Sets the IDE configuration of the SATA channels.

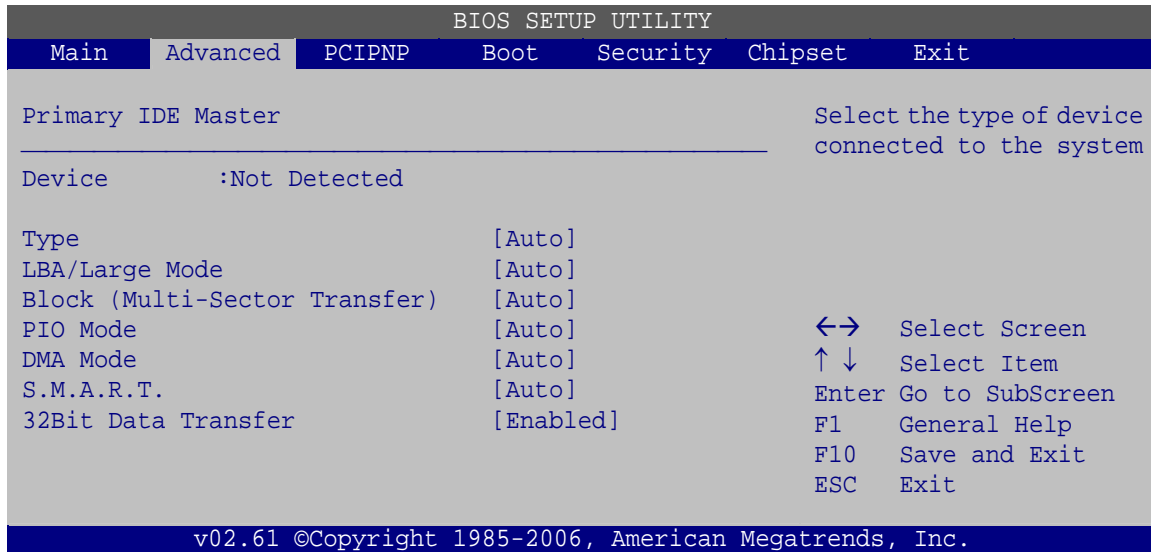

BIOS Menu 5: IDE Master and IDE Slave Configuration

- **Type [Auto]**

Use the **Type** BIOS option select the type of device the AMIBIOS attempts to boot from after the Power-On Self-Test (POST) is complete.

- ➔ **Not Installed** BIOS is prevented from searching for an IDE disk drive on the specified channel.
- ➔ **Auto** **DEFAULT** The BIOS auto detects the IDE disk drive type attached to the specified channel. This setting should be used if an IDE hard disk drive is attached to the specified channel.
- ➔ **CD/DVD** The CD/DVD option specifies that an IDE CD-ROM drive is attached to the specified IDE channel. The BIOS does not attempt to search for other types of IDE disk drives on the specified channel.

TANK-GM45 Embedded System

➔ **ARMD** This option specifies an ATAPI Removable Media Device. These include, but are not limited to:

ZIP

LS-120

- **LBA/Large Mode [Auto]**

Use the **LBA/Large Mode** option to disable or enable BIOS to auto detects LBA (Logical Block Addressing). LBA is a method of addressing data on a disk drive. In LBA mode, the maximum drive capacity is 137 GB.

➔ **Disabled** BIOS is prevented from using the LBA mode control on the specified channel.

➔ **Auto** **DEFAULT** BIOS auto detects the LBA mode control on the specified channel.

- **Block (Multi Sector Transfer) [Auto]**

Use the **Block (Multi Sector Transfer)** to disable or enable BIOS to auto detect if the device supports multi-sector transfers.

➔ **Disabled** BIOS is prevented from using Multi-Sector Transfer on the specified channel. The data to and from the device occurs one sector at a time.

➔ **Auto** **DEFAULT** BIOS auto detects Multi-Sector Transfer support on the drive on the specified channel. If supported the data transfer to and from the device occurs multiple sectors at a time.

- **PIO Mode [Auto]**

Use the **PIO Mode** option to select the IDE PIO (Programmable I/O) mode program timing cycles between the IDE drive and the programmable IDE controller. As the PIO mode increases, the cycle time decreases.

- **Auto** **DEFAULT** BIOS auto detects the PIO mode. Use this value if the IDE disk drive support cannot be determined.
- **0** PIO mode 0 selected with a maximum transfer rate of 3.3 MB/s
- **1** PIO mode 1 selected with a maximum transfer rate of 5.2 MB/s
- **2** PIO mode 2 selected with a maximum transfer rate of 8.3 MB/s
- **3** PIO mode 3 selected with a maximum transfer rate of 11.1 MB/s
- **4** PIO mode 4 selected with a maximum transfer rate of 16.6 MB/s
(This setting generally works with all hard disk drives manufactured after 1999. For other disk drives, such as IDE CD-ROM drives, check the specifications of the drive.)

▪ **DMA Mode [Auto]**

Use the **DMA Mode** BIOS selection to adjust the DMA mode options.

- **Auto** **DEFAULT** BIOS auto detects the DMA mode. Use this value if the IDE disk drive support cannot be determined.
- **SWDMA0** Single Word DMA mode 0 selected with a maximum data transfer rate of 2.1 MB/s
- **SWDMA1** Single Word DMA mode 1 selected with a maximum data transfer rate of 4.2 MB/s
- **SWDMA2** Single Word DMA mode 2 selected with a maximum data transfer rate of 8.3 MB/s
- **MWDMA0** Multi Word DMA mode 0 selected with a maximum data transfer rate of 4.2 MB/s
- **MWDMA1** Multi Word DMA mode 1 selected with a maximum data transfer rate of 13.3 MB/s
- **MWDMA2** Multi Word DMA mode 2 selected with a maximum data transfer rate of 16.6 MB/s
- **UDMA0** Ultra DMA mode 0 selected with a maximum data transfer rate of 16.6 MB/s

TANK-GM45 Embedded System

- ➔ **UDMA1** Ultra DMA mode 1 selected with a maximum data transfer rate of 25 MB/s
- ➔ **UDMA2** Ultra DMA mode 2 selected with a maximum data transfer rate of 33.3 MB/s
- ➔ **UDMA3** Ultra DMA mode 3 selected with a maximum data transfer rate of 44 MB/s (To use this mode, it is required that an 80-conductor ATA cable is used.)
- ➔ **UDMA4** Ultra DMA mode 4 selected with a maximum data transfer rate of 66.6 MB/s (To use this mode, it is required that an 80-conductor ATA cable is used.)
- ➔ **UDMA5** Ultra DMA mode 5 selected with a maximum data transfer rate of 99.9 MB/s (To use this mode, it is required that an 80-conductor ATA cable is used.)

- **S.M.A.R.T [Auto]**

Use the **S.M.A.R.T** option to auto-detect, disable or enable Self-Monitoring Analysis and Reporting Technology (SMART) on the drive on the specified channel. **S.M.A.R.T** predicts impending drive failures. The **S.M.A.R.T** BIOS option enables or disables this function.

- ➔ **Auto** **DEFAULT** BIOS auto detects HDD SMART support.
- ➔ **Disabled** Prevents BIOS from using the HDD SMART feature.
- ➔ **Enabled** Allows BIOS to use the HDD SMART feature

- **32Bit Data Transfer [Enabled]**

Use the **32Bit Data Transfer** BIOS option to enables or disable 32-bit data transfers.

- ➔ **Disabled** Prevents the BIOS from using 32-bit data transfers.
- ➔ **Enabled** **DEFAULT** Allows BIOS to use 32-bit data transfers on supported hard disk drives.

4.3.3 Super IO Configuration

Use the **Super IO Configuration** menu (BIOS Menu 6) to set or change the configurations for the FDD controllers, parallel ports and serial ports.

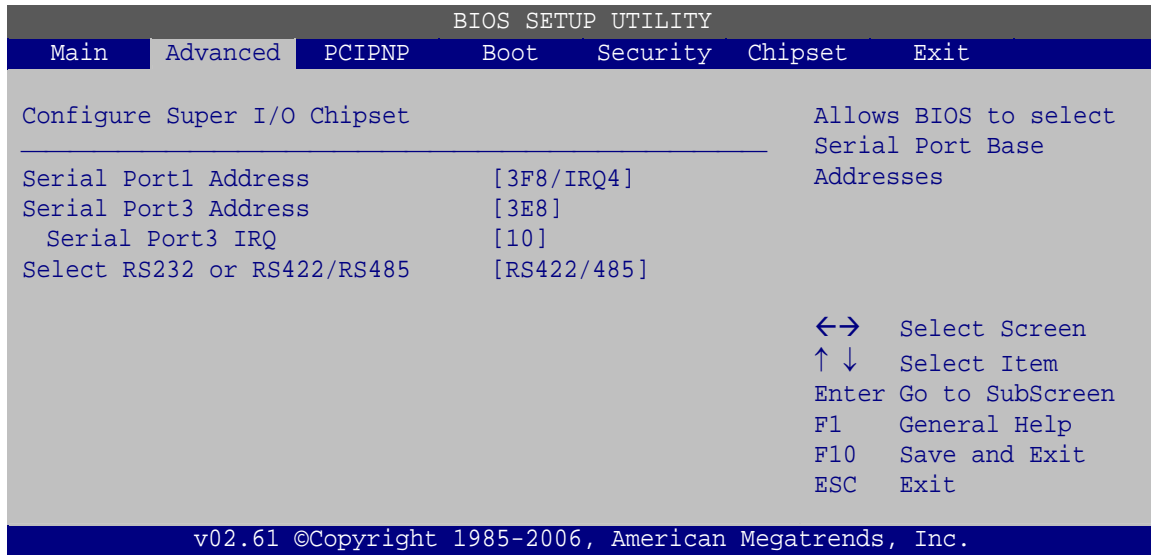

BIOS Menu 6: Super IO Configuration

- **Serial Port1 Address [3F8/IRQ4]**

Use the **Serial Port1 Address** option to select the Serial Port 1 base address.

- ➔ **Disabled** No base address is assigned to Serial Port 1
- ➔ **3F8/IRQ4** **DEFAULT** Serial Port 1 I/O port address is 3F8 and the interrupt address is IRQ4
- ➔ **2F8/IRQ3** Serial Port 1 I/O port address is 2F8 and the interrupt address is IRQ3
- ➔ **3E8/IRQ4** Serial Port 1 I/O port address is 3E8 and the interrupt address is IRQ4
- ➔ **2E8/IRQ3** Serial Port 1 I/O port address is 2E8 and the interrupt address is IRQ3

TANK-GM45 Embedded System

- **Serial Port3 Address [3E8]**

Sets the port address of serial port 3.

- Disabled
- 3E8 **DEFAULT**
- 2E8

- **Serial Port3 IRQ [10]**

Sets the interrupt request for serial port 3.

- 10 **DEFAULT**

4.3.4 Hardware Health Configuration

The **Hardware Health Configuration** menu (**BIOS Menu 7**) shows the operating temperature, fan speeds and system voltages.

```

BIOS SETUP UTILITY
Main  Advanced  PCIPNP  Boot  Security  Chipset  Power  Exit
-----
Hardware Health Event Monitoring
-----
CPU Temperature 1           :37°C/98°F
System Temperature 2       :32°C/89°F
PWM Temperature            :39°C/102°F

CPU Core                   :1.120 V
+1.05V                     :1.040 V
+3.30V                     :3.312 V
+5.00V                     :5.187 V
+12.0V                     :11.968 V
+1.5V                      :1.456 V
+1.8V                      :1.792 V
+5VSB                      :5.187 V
VBAT                      :3.200 V

←→  Select Screen
↑↓  Select Item
Enter Go to SubScreen
F1   General Help
F10  Save and Exit
ESC  Exit

v02.61 ©Copyright 1985-2006, American Megatrends, Inc.

```

BIOS Menu 7: Hardware Health Configuration

- **Hardware Health Monitoring**

The following system parameters and values are shown. The system parameters that are monitored are:

- System Temperatures:
 - CPU Temperature 1
 - System Temperature 2
 - PWM Temperature
- Voltages:
 - CPU Core
 - +1.05V
 - +3.30V
 - +5.00V
 - +12.0V
 - +1.5V
 - +1.8V
 - +5VSB
 - VBAT

4.3.5 AHCI Configuration

**NOTE:**

Advanced Host Controller Interface (AHCI) is a new programming interface for SATA host controllers. AHCI systems do not have master/slave designation for SATA devices, each device is treated as a master, and hardware-assisted native command queuing.

Use the **AHCI Settings** menu (**BIOS Menu 8**) to report on the auto-detection of devices connected to the onboard SATA drive connectors.

TANK-GM45 Embedded System

```

                                BIOS SETUP UTILITY
Main  Advanced  PCIPNP  Boot  Security  Chipset  Power  Exit
-----
AHCI Settings
-----
> AHCI Port0 [Not Detected]
> AHCI Port1 [Not Detected]

While entering setup
BIOS auto detects the
presence of IDE devices.
This displays the status
of auto detection of IDE
devices.

<=>  Select Screen
↑↓   Select Item
Enter Go to SubScreen
F1   General Help
F10  Save and Exit
ESC  Exit

v02.61 ©Copyright 1985-2006, American Megatrends, Inc.

```

BIOS Menu 8: AHCI Configuration

- **AHCI Port n [Not Detected]**

Use the **AHCI Port n** BIOS option to check what AHCI (Advanced Host Controller Interface) devices are detected to a specified SATA drive connector. If a device is detected, selecting the BIOS option, e.g. “**AHCI Port 1**” opens a new window.

4.3.5.1 AHCI Port n

Use the **AHCI Port n** configuration menu (**BIOS Menu 9**) to configure the drive connected to SATA connector n.

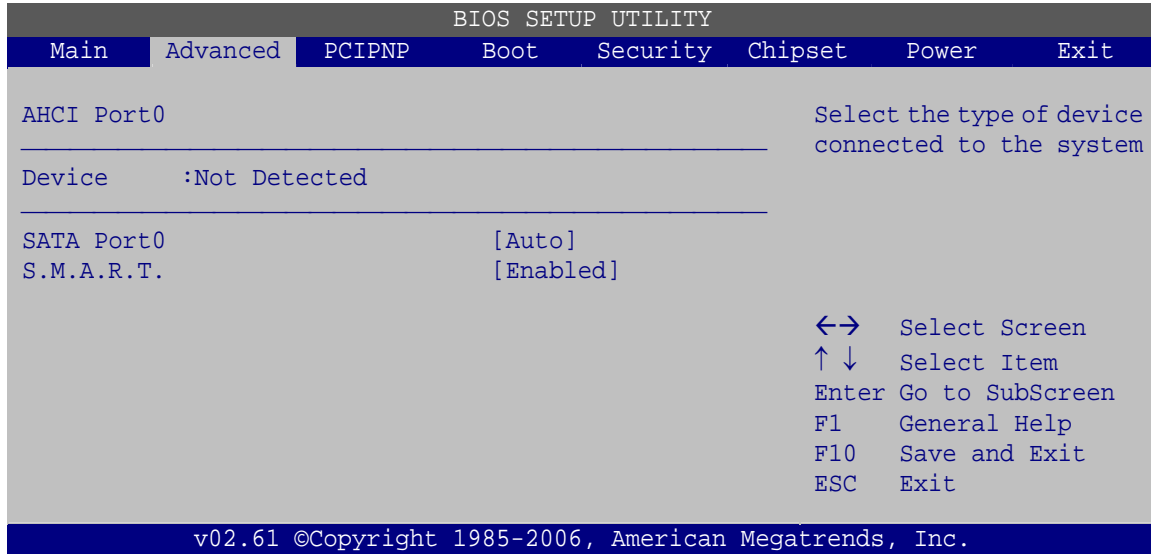

BIOS Menu 9: AHCI Port n Configuration Menu

- **SATA Port n [Auto]**

Use the **SATA Port n** option to enable the system to auto-detect the type of drive connected to SATA drive connector n.

- **S.M.A.R.T [Enabled]**

Use the **S.M.A.R.T** option to enable S.M.A.R.T (Self-Monitoring, Analysis, and Reporting Technology) on the drive connected to SATA drive connector n.

➔ **Enabled** **DEFAULT** S.M.A.R.T is enabled on the drive connected to SATA drive connector n on the system

➔ **Disabled** S.M.A.R.T is disabled on the drive connected to SATA drive connector n on the system

4.3.6 Remote Access Configuration

Use the **Remote Access Configuration** menu (BIOS Menu 10) to configure remote access parameters. The **Remote Access Configuration** is an AMIBIOS feature and allows a remote host running a terminal program to display and configure the BIOS settings.

TANK-GM45 Embedded System

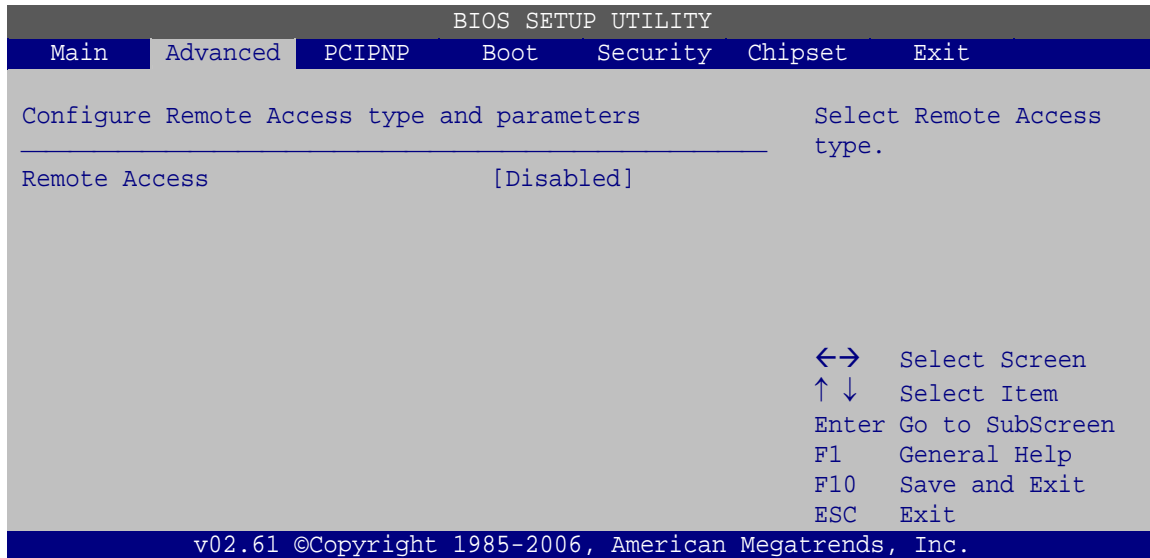

BIOS Menu 10: Remote Access Configuration

- **Remote Access [Disabled]**

Use the **Remote Access** option to enable or disable access to the remote functionalities of the system.

- ➔ **Disabled** **DEFAULT** Remote access is disabled.
- ➔ **Enabled** Remote access configuration options shown below appear:
 - Serial Port Number
 - Serial Port Mode
 - Redirection after BIOS POST
 - Terminal Type

These configuration options are discussed below.

- **Serial Port Number [COM1]**

Use the **Serial Port Number** option allows to select the serial port used for remote access.

- ➔ **COM1** **DEFAULT** System is remotely accessed through COM1

NOTE: Make sure the selected COM port is enabled through the Super I/O configuration menu.

- **Base Address, IRQ [3F8h,4]**

The **Base Address, IRQ** option cannot be configured and only shows the interrupt address of the serial port listed above.

- **Serial Port Mode [115200 8,n,1]**

Use the **Serial Port Mode** option to select baud rate through which the console redirection is made. The following configuration options are available

- 115200 8,n,1 **DEFAULT**
- 57600 8,n,1
- 38400 8,n,1
- 19200 8,n,1
- 09600 8,n,1



NOTE:

Identical baud rate setting must be set on the host (a management computer running a terminal software) and the slave

- **Redirection After BIOS POST [Always]**

Use the **Redirection After BIOS POST** option to specify when console redirection should occur.

- | | | |
|---|------------------------------|--|
| → | Disabled | The console is not redirected after POST |
| → | Boot Loader | Redirection is active during POST and during Boot Loader |
| → | Always DEFAULT | Redirection is always active (Some OSes may not work if set to Always) |

TANK-GM45 Embedded System

- **Terminal Type [ANSI]**

Use the **Terminal Type** BIOS option to specify the remote terminal type.

- ➔ **ANSI** **DEFAULT** The target terminal type is ANSI
- ➔ **VT100** The target terminal type is VT100
- ➔ **VT-UTF8** The target terminal type is VT-UTF8

4.3.7 USB Configuration

Use the **USB Configuration** menu (BIOS Menu 11) to read USB configuration information and configure the USB settings.

```

BIOS SETUP UTILITY
Main  Advanced  PCIPNP  Boot  Security  Chipset  Exit
-----
USB Configuration                               Disabled
                                                Enabled
Module Version - 2.24.3-13.4

USB Devices Enabled:
    None

USB Functions                                     [Enabled]
USB 2.0 Controller                               [Enabled]
Legacy USB Support                               [Enabled]
USB 2.0 Controller Mode                          [HiSpeed]

<=> Select Screen
↑↓ Select Item
Enter Go to SubScreen
F1 General Help
F10 Save and Exit
ESC Exit

v02.61 ©Copyright 1985-2006, American Megatrends, Inc.
    
```

BIOS Menu 11: USB Configuration

- **USB Function [Enabled]**

When enabled, USB devices can be used in the USB slots.

- Disabled
- Enabled **DEFAULT**

- **Legacy USB Support [Enabled]**

Use the **Legacy USB Support** BIOS option to enable USB mouse and USB keyboard support.

Normally if this option is not enabled, any attached USB mouse or USB keyboard does not become available until a USB compatible operating system is fully booted with all USB drivers loaded. When this option is enabled, any attached USB mouse or USB keyboard can control the system even when there is no USB driver loaded onto the system.

- ➔ **Disabled** Legacy USB support disabled
- ➔ **Enabled** **DEFAULT** Legacy USB support enabled
- ➔ **Auto** Legacy USB support disabled if no USB devices are connected

▪ **USB2.0 Controller Mode [HiSpeed]**

Use the **USB2.0 Controller Mode** option to set the speed of the USB2.0 controller.

- ➔ **FullSpeed** The controller is capable of operating at 12 Mb/s
- ➔ **HiSpeed** **DEFAULT** The controller is capable of operating at 480 Mb/s

4.3.8 Power Configuration

The **Power Configuration** menu (**BIOS Menu 12**) configures the power options.

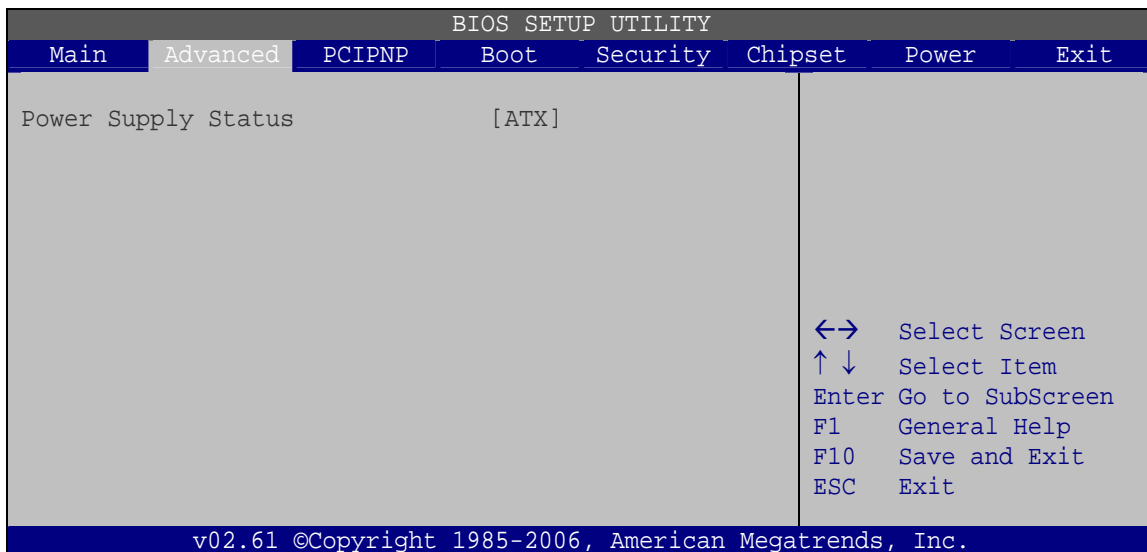

BIOS Menu 12: Power Configuration

TANK-GM45 Embedded System

- **Power Supply Status [ATX]**

Shows the setting of the Power Selection Jumper.

4.4 PCI/PnP

Use the **PCI/PnP** menu (BIOS Menu 13) to configure advanced PCI and PnP settings.



WARNING!

Setting wrong values for the BIOS selections in the PCIPnP BIOS menu may cause the system to malfunction.

```

BIOS SETUP UTILITY
Main  Advanced  PCIPNP  Boot  Security  Chipset  Exit
-----
Advanced PCI/PnP Settings
-----
WARNING: Setting wrong values in below sections
         may cause system to malfunction

IRQ3           [Reserved]
IRQ4           [Reserved]
IRQ5           [Available]
IRQ7           [Available]
IRQ9           [Available]
IRQ10          [Available]
IRQ11          [Available]
IRQ14          [Available]
IRQ15          [Available]

DMA Channel 0  [Available]
DMA Channel 1  [Available]
DMA Channel 3  [Available]
DMA Channel 5  [Available]
DMA Channel 6  [Available]
DMA Channel 7  [Available]

Reserved Memory Size [Disabled]

Available: Specified
IRQ is available to be
used by PCI/PnP
devices.
Reserved: Specified
IRQ is reserved for
use by Legacy ISA
devices.

←→  Select Screen
↑↓  Select Item
Enter Go to SubScreen
F1   General Help
F10  Save and Exit
ESC  Exit

v02.61 ©Copyright 1985-2006, American Megatrends, Inc.

```

BIOS Menu 13: PCI/PnP Configuration

- **IRQ# [Available]**

Use the **IRQ#** address to specify what IRQs can be assigned to a particular peripheral device.

- ➔ **Available** **DEFAULT** The specified IRQ is available to be used by PCI/PnP devices
- ➔ **Reserved** The specified IRQ is reserved for use by Legacy ISA devices

Available IRQ addresses are:

- IRQ3
- IRQ4
- IRQ5
- IRQ7
- IRQ9
- IRQ10
- IRQ 11
- IRQ 14
- IRQ 15

- **DMA Channel# [Available]**

Use the **DMA Channel#** option to assign a specific DMA channel to a particular PCI/PnP device.

- ➔ **Available** **DEFAULT** The specified DMA is available to be used by PCI/PnP devices
- ➔ **Reserved** The specified DMA is reserved for use by Legacy ISA devices

Available DMA Channels are:

- DM Channel 0
- DM Channel 1
- DM Channel 3

TANK-GM45 Embedded System

- DM Channel 5
- DM Channel 6
- DM Channel 7

- **Reserved Memory Size [Disabled]**

Use the **Reserved Memory Size** BIOS option to specify the amount of memory that should be reserved for legacy ISA devices.

| | | | |
|---|-----------------|----------------|---|
| ➔ | Disabled | DEFAULT | No memory block reserved for legacy ISA devices |
| ➔ | 16K | | 16 KB reserved for legacy ISA devices |
| ➔ | 32K | | 32 KB reserved for legacy ISA devices |
| ➔ | 64K | | 54 KB reserved for legacy ISA devices |

4.5 Boot

Use the **Boot** menu (BIOS Menu 14) to configure system boot options.

```

BIOS SETUP UTILITY
Main  Advanced  PCIPNP  Boot  Security  Chipset  Exit
-----
Boot Settings          Configure settings
                       during system boot.
> Boot Settings Configuration
> Boot Device Priority
> Hard Disk Drives

                                  ←→  Select Screen
                                  ↑↓  Select Item
                                  Enter Go to SubScreen
                                  F1   General Help
                                  F10  Save and Exit
                                  ESC  Exit

v02.61 ©Copyright 1985-2006, American Megatrends, Inc.

```

BIOS Menu 14: Boot

4.5.1 Boot Settings Configuration

Use the **Boot Settings Configuration** menu (BIOS Menu 15) to configure advanced system boot options.

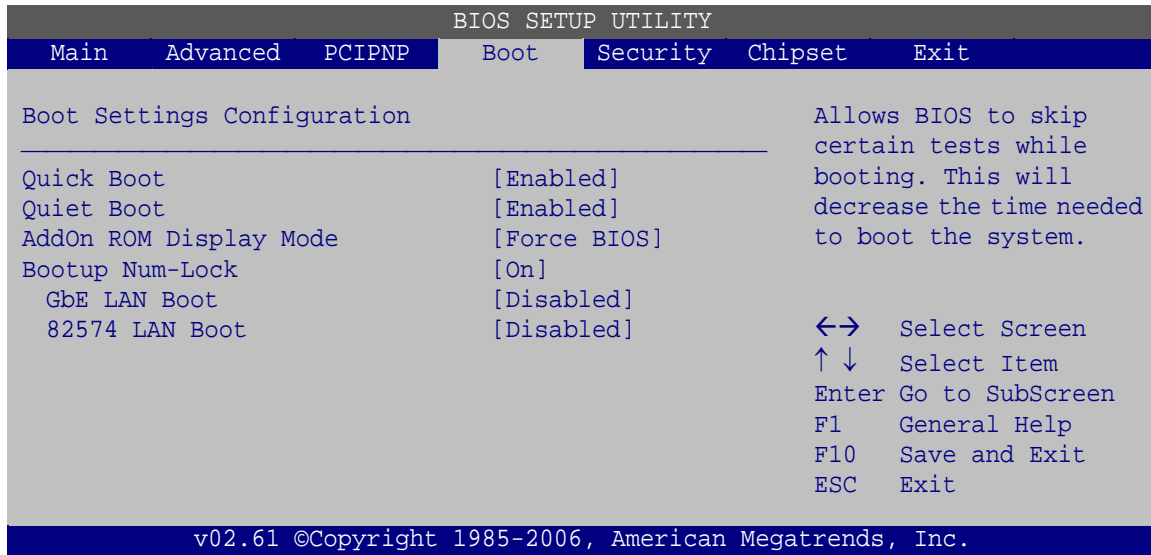

BIOS Menu 15: Boot Settings Configuration

- **Quick Boot [Enabled]**

Use the **Quick Boot** BIOS option to make the computer speed up the boot process.

- ➔ **Disabled** No POST procedures are skipped
- ➔ **Enabled** **DEFAULT** Some POST procedures are skipped to decrease the system boot time

- **Quiet Boot [Enabled]**

Use the **Quiet Boot** BIOS option to select the screen display when the system boots.

- ➔ **Disabled** Normal POST messages displayed
- ➔ **Enabled** **DEFAULT** OEM Logo displayed instead of POST messages

TANK-GM45 Embedded System

- **AddOn ROM Display Mode [Force BIOS]**

Use the **AddOn ROM Display Mode** option to allow add-on ROM (read-only memory) messages to be displayed.

- ➔ **Force BIOS** **DEFAULT** The system forces third party BIOS to display during system boot.
- ➔ **Keep Current** The system displays normal information during system boot.

- **Bootup Num-Lock [On]**

Use the **Bootup Num-Lock** BIOS option to specify if the number lock setting must be modified during boot up.

- ➔ **Off** Does not enable the keyboard Number Lock automatically. To use the 10-keys on the keyboard, press the Number Lock key located on the upper left-hand corner of the 10-key pad. The Number Lock LED on the keyboard lights up when the Number Lock is engaged.
- ➔ **On** **DEFAULT** Allows the Number Lock on the keyboard to be enabled automatically when the computer system boots up. This allows the immediate use of the 10-key numeric keypad located on the right side of the keyboard. To confirm this, the Number Lock LED light on the keyboard is lit.

- **GbE LAN Boot [Disabled]**

Use the **GbE LAN Boot** option to enable the system to be booted from a remote system.

- ➔ **Disabled** **DEFAULT** Cannot be booted from a remote system through the LAN
- ➔ **Enabled** Can be booted from a remote system through the LAN

4.5.2 Boot Device Priority

Use the **Boot Device Priority** menu (BIOS Menu 16) to specify the boot sequence from the available devices. The drive sequence also depends on the boot sequence in the individual device section.

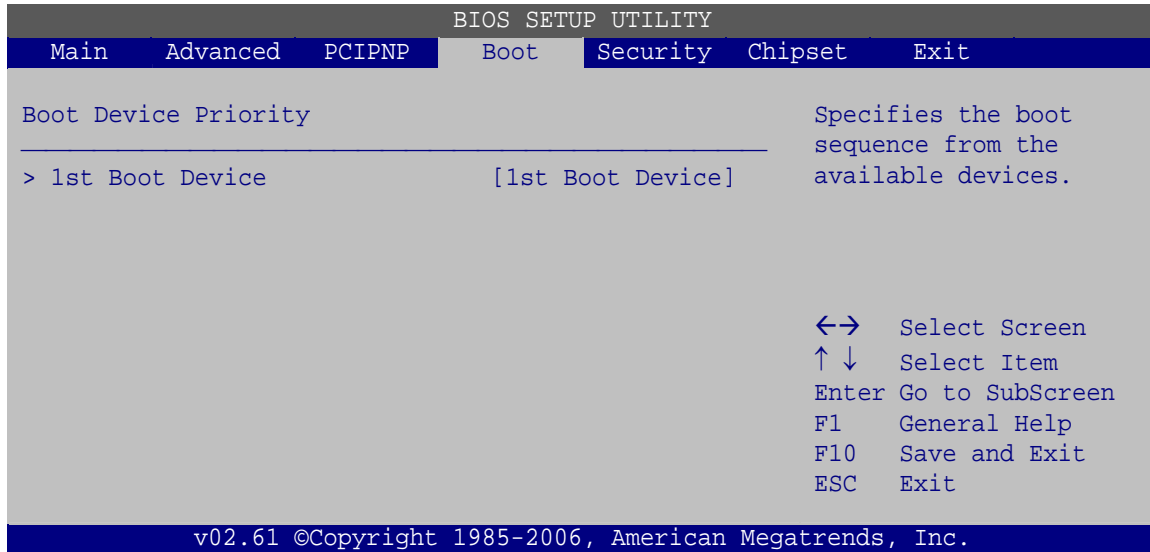

BIOS Menu 16: Boot Device Priority Settings

TANK-GM45 Embedded System

4.5.3 Hard Disk Drives

Use the **Hard Disk Drives** menu to specify the boot sequence of the available HDDs. Only installed hard drives are shown.

```

BIOS SETUP UTILITY
Main  Advanced  PCIPNP  Boot  Security  Chipset  Exit
-----
Hard Disk Drives
-----
> 1st Drive          [Hard Drive 1]
-----
Specifies the boot
sequence from the
available devices.

<=>  Select Screen
↑↓   Select Item
Enter Go to SubScreen
F1   General Help
F10  Save and Exit
ESC  Exit

v02.61 ©Copyright 1985-2006, American Megatrends, Inc.

```

BIOS Menu 17: Hard Disk Drives

4.6 Security

Use the **Security** menu (BIOS Menu 18) to set system and user passwords.

```

BIOS SETUP UTILITY
Main  Advanced  PCIPNP  Boot  Security  Chipset  Exit
-----
Security Settings
-----
Supervisor Password  :Not Installed
User Password        :Not Installed

Change Supervisor Password
Change User Password

<=>  Select Screen
↑↓   Select Item
Enter Go to SubScreen
F1   General Help
F10  Save and Exit
ESC  Exit

v02.61 ©Copyright 1985-2006, American Megatrends, Inc.

```

BIOS Menu 18: Security

- **Change Supervisor Password**

Use the **Change Supervisor Password** to set or change a supervisor password. The default for this option is **Not Installed**. If a supervisor password must be installed, select this field and enter the password. After the password has been added, **Install** appears next to **Change Supervisor Password**.

- **Change User Password**

Use the **Change User Password** to set or change a user password. The default for this option is **Not Installed**. If a user password must be installed, select this field and enter the password. After the password has been added, **Install** appears next to **Change User Password**.

4.7 Chipset

Use the **Chipset** menu (BIOS Menu 19) to access the Northbridge and Southbridge configuration menus



WARNING!

Setting the wrong values for the Chipset BIOS selections in the Chipset BIOS menu may cause the system to malfunction.

TANK-GM45 Embedded System

```

BIOS SETUP UTILITY
Main  Advanced  PCIPNP  Boot  Security  Chipset  Exit
-----
Advanced Chipset Settings                                Options for VIA® VX800
-----
> North Bridge Configuration
> South Bridge Configuration

                                  ←→  Select Screen
                                  ↑↓  Select Item
                                  Enter Go to SubScreen
                                  F1   General Help
                                  F10  Save and Exit
                                  ESC  Exit

v02.61 ©Copyright 1985-2006, American Megatrends, Inc.

```

BIOS Menu 19: Chipset

4.7.1 Northbridge Configuration

Use the **Northbridge Configuration** configures the system chipset.

```

BIOS SETUP UTILITY
Main  Advanced  PCIPNP  Boot  Security  Chipset  Exit
-----
North Bridge Configuration                                Options
-----
Memory Hole [Disabled]                                  15MB-16MB
Internal Graphics Mode Select [Enabled, 32MB]

                                  ←→  Select Screen
                                  ↑↓  Select Item
                                  Enter Go to SubScreen
                                  F1   General Help
                                  F10  Save and Exit
                                  ESC  Exit

v02.61 ©Copyright 1985-2006, American Megatrends, Inc.

```

BIOS Menu 20:Northbridge Chipset Configuration

- **Memory Hole [Disabled]**

Use the **Memory Hole** option to reserve memory space between 15 MB and 16 MB for ISA expansion cards that require a specified area of memory to work properly. If an older

ISA expansion card is used, please refer to the documentation that came with the card to see if it is necessary to reserve the space.

- ➔ **Disabled** **DEFAULT** Memory is not reserved for ISA expansion cards
- ➔ **15 MB–16 MB** Between 15 MB and 16 MB of memory is reserved for ISA expansion cards

- **Internal Graphics Mode Select [Enable, 32MB]**

Use the **Internal Graphic Mode Select** option to specify the amount of system memory that can be used by the Internal graphics device.

- ➔ **Disable**
- ➔ **Enable, 32MB** **DEFAULT** 32 MB of memory used by internal graphics device
- ➔ **Enable, 64MB** 64 MB of memory used by internal graphics device
- ➔ **Enable, 128MB** 128 MB of memory used by internal graphics device

4.7.2 Southbridge Configuration

The **Southbridge Configuration** configures the system chipset.

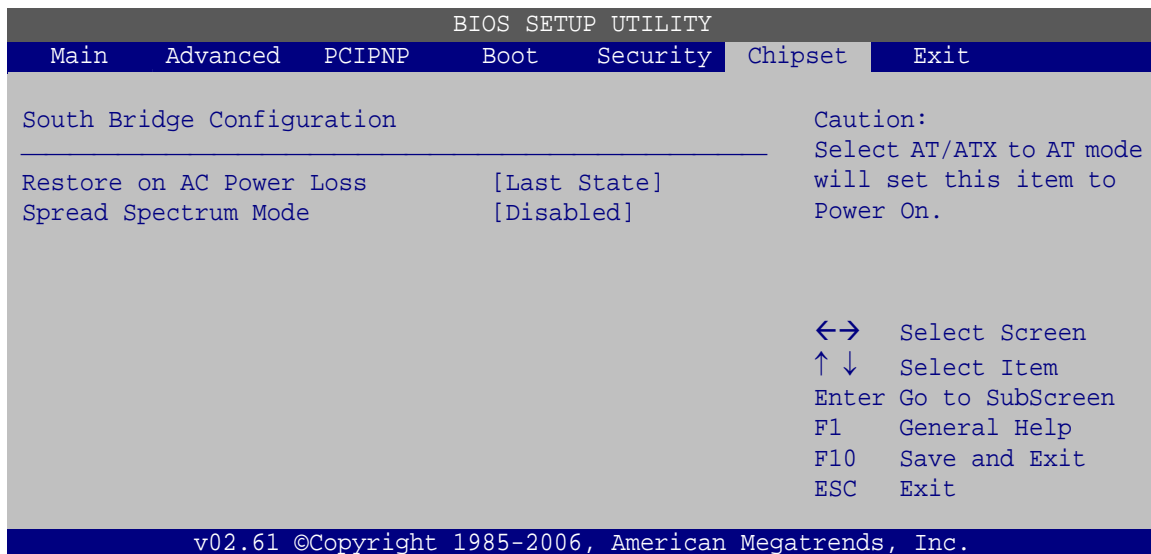

BIOS Menu 21:Southbridge Chipset Configuration

TANK-GM45 Embedded System

▪ Restore on AC Power Loss [Last State]

Use the **Restore on AC Power Loss** BIOS option to specify what state the system returns to if there is a sudden loss of power to the system.

- ➔ **Power Off** The system remains turned off
- ➔ **Power On** The system turns on
- ➔ **Last State** **DEFAULT** The system returns to its previous state. If it was on, it turns itself on. If it was off, it remains off.

▪ Spread Spectrum [Disabled]

Use the **Spread Spectrum** option to reduce the EMI. Excess EMI is generated when the system clock generator pulses have extreme values. Spreading the pulse spectrum modulates changes in the extreme values from spikes to flat curves, thus reducing the EMI. This benefit may in some cases be outweighed by problems with timing-critical devices, such as a clock-sensitive SCSI device.

- ➔ **Disabled** **DEFAULT** EMI not reduced
- ➔ **Enabled** EMI reduced

4.8 Exit

Use the **Exit** menu (BIOS Menu 22) to load default BIOS values, optimal failsafe values and to save configuration changes.

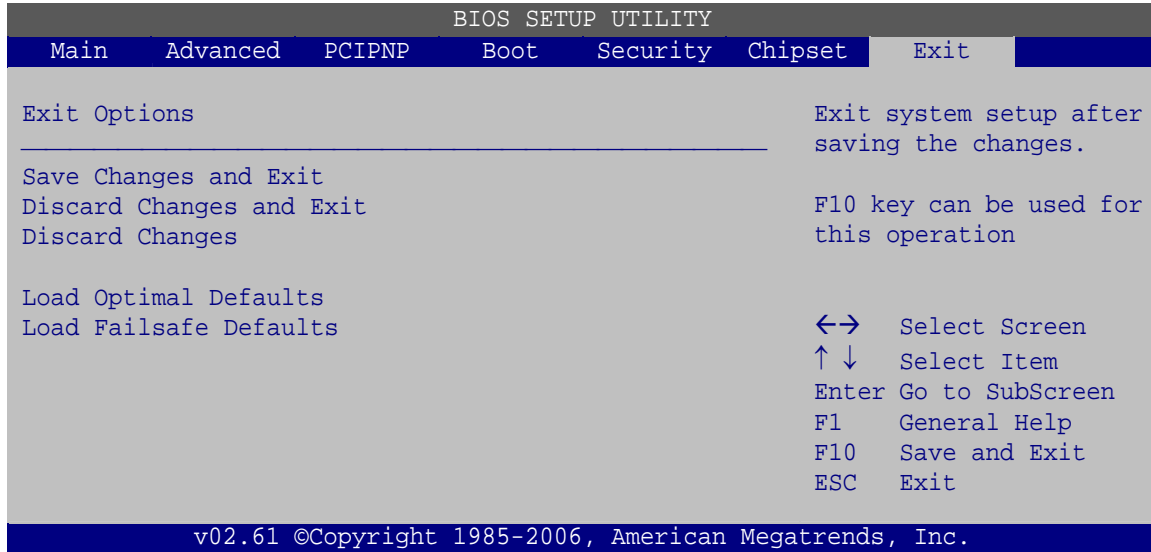

BIOS Menu 22:Exit

- **Save Changes and Exit**

Use the **Save Changes and Exit** option to save the changes made to the BIOS options and to exit the BIOS configuration setup program.

- **Discard Changes and Exit**

Use the **Discard Changes and Exit** option to exit the BIOS configuration setup program without saving the changes made to the system.

- **Discard Changes**

Use the **Discard Changes** option to discard the changes and remain in the BIOS configuration setup program.

- **Load Optimal Defaults**

Use the **Load Optimal Defaults** option to load the optimal default values for each of the parameters on the Setup menus. **F9 key can be used for this operation.**

- **Load Failsafe Defaults**

Use the **Load Failsafe Defaults** option to load failsafe default values for each of the parameters on the Setup menus. **F8 key can be used for this operation.**

Appendix

A

One Key Recovery

A.1 One Key Recovery Introduction

The IEI one key recovery is an easy-to-use front end for the Norton Ghost system backup and recovery tool. The one key recovery provides quick and easy shortcuts for creating a backup and reverting to that backup or for reverting to the factory default settings.

To create the system backup the main storage device must be split into two partitions (three partitions for Linux). The first partition will be for the operating system, while the second partition will be invisible to the operating system and contain the backup made by the one key recovery software.

A.1.1 System Requirement

The partition created for recovery images must be big enough to contain both the factory default image and the user backup image. The size must be calculated before creating the partitions. Please take the following table as a reference when calculating the size of the partition.

| | OS | OS Image after Ghost | Compression Ratio |
|------------------------|--------|----------------------|-------------------|
| Windows® 7 | 7 GB | 5 GB | 70% |
| Windows® XPE | 776 MB | 560 MB | 70% |
| Windows® CE 6.0 | 36 MB | 28 MB | 77% |



NOTE:

Specialized tools are required to change the partition size if the operating system is already installed.

TANK-GM45 Embedded System

A.1.2 Supported Operating System

The recovery CD is compatible with both Microsoft Windows and Linux operating system (OS). The supported OS versions are listed below.

- Microsoft Windows
 - Windows XP (Service Pack 2 or 3 required)
 - Windows Vista
 - Windows 7
 - Windows CE 5.0
 - Windows CE 6.0
 - Windows XP Embedded
- Linux
 - Fedora Core 12 (Constantine)
 - Fedora Core 11 (Leonidas)
 - Fedora Core 10 (Cambridge)
 - Fedora Core 8 (Werewolf)
 - Fedora Core 7 (Moonshine)
 - RedHat RHEL-5.4
 - RedHat 9 (Ghirke)
 - Ubuntu 8.10 (Intrepid)
 - Ubuntu 7.10 (Gutsy)
 - Ubuntu 6.10 (Edgy)
 - Debian 5.0 (Lenny)
 - Debian 4.0 (Etch)
 - SuSe 11.2
 - SuSe 11.3



NOTE:

Installing unsupported OS versions may cause the recovery tool to fail.

**NOTE:**

The recovery CD can only be used with IEI products. The software will fail to run and a warning message will appear when used on non-IEI hardware.

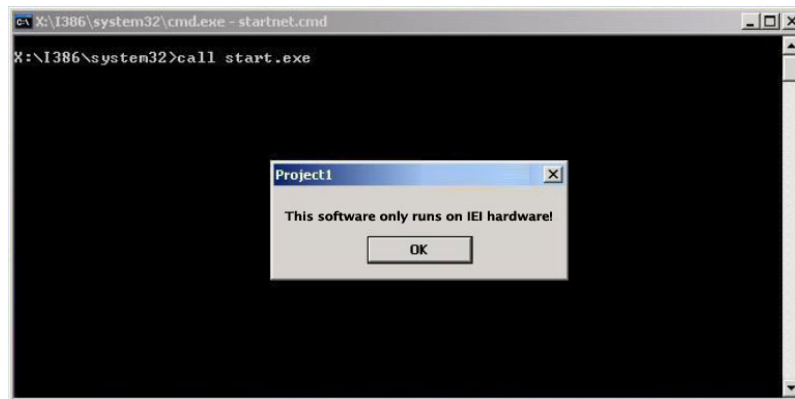

A.2 Initial Setup Procedure for Windows

Prior to using the recovery tool to backup or restore system, a few setup procedures are required.

- Step 1:** Hardware and BIOS setup
- Step 2:** Create partitions
- Step 3:** Build-up recovery partition
- Step 4:** Install operating system, drivers and system applications.
- Step 5:** Create factory default image

The detailed descriptions are described in the following sections.

TANK-GM45 Embedded System



NOTE:

The setup procedures described below are for Microsoft Windows operating system users. For Linux system, most setup procedures are the same with Microsoft Windows except for several steps which is described in **Section A.3**.

A.2.1 Hardware and BIOS Setup

- Step 1:** Install a hard driver or SSD in the TANK-GM45. An unformatted and unpartitioned disk is recommended.
- Step 2:** Connect an optical disk drive to the TANK-GM45 and insert the recovery CD.
- Step 3:** Turn on the system.
- Step 4:** Press the <DELETE> key as soon as the system is turned on to enter the BIOS.
- Step 5:** Select the connected optical disk drive as the 1st boot device. (**Boot** → **Boot Device Priority** → **1st Boot Device**).
- Step 6:** Press F10 then "Y" to save changes and restart the computer. Continue to the next section for instructions on partitioning the internal storage.

A.2.2 Create Partitions

- Step 1:** When prompted, press any key to boot from the recovery CD. It will take a while to launch the recovery tool. Please be patient.
- Step 2:** The recovery tool setup menu is shown as below.

```
C:\X:\I386\system32\cmd.exe
1.Ghost Execution
2.System Configuration For Windows
3.System Configuration For Linux
4.Exit
5.CMD
Type the number to print text._
```

Figure A-1: Recovery Tool Setup Menu

Step 3: Type <5> and press <Enter>.

```
C:\X:\I386\system32\cmd.exe
1.Ghost Execution
2.System Configuration For Windows
3.System Configuration For Linux
4.Exit
5.CMD
Type the number to print text. 5
```

Figure A-2: Command Mode

Step 4: The command prompt window appears. Type the following commands (marked in red) to create two partitions. One is for the OS installation; the other is for saving recovery files and images which will be an invisible partition.

```
system32>diskpart
DISKPART>list vol
DISKPART>sel disk 0
DISKPART>create part pri size= ____
DISKPART>assign letter=N
DISKPART>create part pri size= ____
DISKPART>assign letter=F
DISKPART>exit
system32>format N: /fs:ntfs /q /y
system32>format F: /fs:ntfs /q /v:Recovery /y
system32>exit
```

```

X:\I386\SYSTEM32\CMD.EXE
X:\I386\SYSTEM32>diskpart → Starts the Microsoft disk partitioning tool.

Microsoft DiskPart version 5.2.3790.1830
Copyright (C) 1999-2001 Microsoft Corporation.
On computer: MININT-JUC

DISKPART> list vol → Show partition information

Volume ### Ltr Label Fs Type Size Status Info
-----
Volume 0 X CD_ROM CDFS DUD-ROM 405 MB Healthy Boot
Volume 1 D FAT32 Removeable 3854 MB Healthy

DISKPART> sel disk 0 → Select a disk
Disk 0 is now the selected disk.

DISKPART> create part pri size=2000 → Create partition 1 and assign a size.
This partition is for OS installation.
DiskPart succeeded in creating the specified partition.

DISKPART> assign letter=N → Assign partition 1 a code name (N).
DiskPart successfully assigned the drive letter or mount point.

DISKPART> create part pri size=1800 → Create partition 2 and assign a size.
This partition is for recovery images.
DiskPart succeeded in creating the specified partition.

DISKPART> assign letter=F → Assign partition 2 a code name (F).
DiskPart successfully assigned the drive letter or mount point.

DISKPART> exit → Exit diskpart

X:\I386\SYSTEM32>format n: /fs:ntfs /q /y → Format partition 1 (N) as NTFS format.
The type of the file system is RAW.
The new file system is NTFS.
QuickFormatting 2000M
Creating file system structures.
Format complete.
2048254 KB total disk space.
2035620 KB are available.

X:\I386\SYSTEM32>format f: /fs:ntfs /q /v:Recovery /y → Formate partition 2 (F) as NTFS formate and
name it as "Recovery".
The type of the file system is RAW.
The new file system is NTFS.
QuickFormatting 1804M
Creating file system structures.
Format complete.
1847474 KB total disk space.
1835860 KB are available.

X:\I386\SYSTEM32>exit → Exit Windows PE
  
```

Figure A-3: Partition Creation Commands

NOTE:

Use the following commands to check if the partitions were created successfully.

```
X:\I386\SYSTEM32>diskpart
Microsoft DiskPart version 5.2.3790.1830
Copyright (C) 1999-2001 Microsoft Corporation.
On computer: MININT-JUC
DISKPART> sel disk 0
Disk 0 is now the selected disk.
DISKPART> list part
   Partition ###   Type              Size              Offset
-----
   Partition 1     Primary           2000 MB           32 KB
   Partition 2     Primary           1804 MB           2000 MB
DISKPART> exit
```

- Step 5:** Press any key to exit the recovery tool and automatically reboot the system.
Please continue to the following procedure: Build-up Recovery Partition.

A.2.3 Build-up Recovery Partition

- Step 1:** Press any key to boot from the recovery CD. It will take a while to launch the recovery tool. Please be patient.
- Step 2:** When the recovery tool setup menu appears, type <2> and press <Enter>.

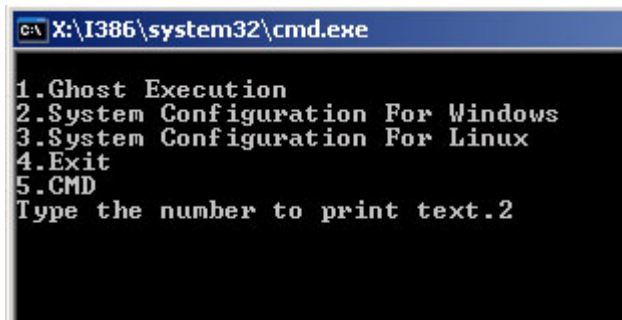

```
C:\X:\I386\system32\cmd.exe
1.Ghost Execution
2.System Configuration For Windows
3.System Configuration For Linux
4.Exit
5.CMD
Type the number to print text.2
```

Figure A-4: System Configuration for Windows

- Step 3:** The Symantec Ghost window appears and starts configuring the system to build-up a recovery partition. In this process, the partition which is created for

TANK-GM45 Embedded System

recovery files in **Section A.2.2** is hidden and the recovery tool is saved in this partition.

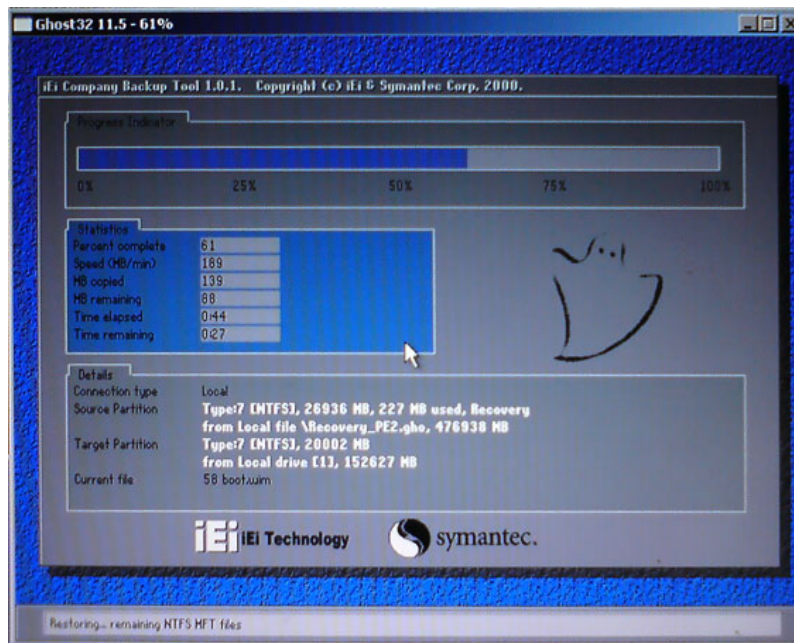

Figure A-5: Build-up Recovery Partition

Step 4: After completing the system configuration, press any key in the following window to reboot the system.

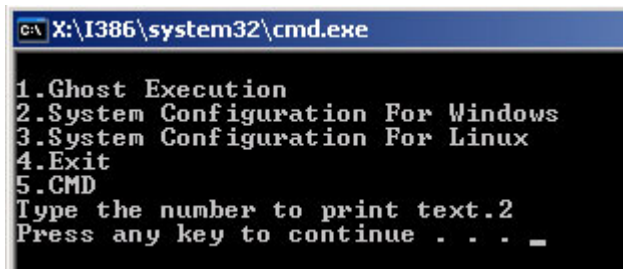

Figure A-6: Press any key to continue

Step 5: Eject the recovery CD.

A.2.4 Create Factory Default Image



NOTE:

Before creating the factory default image, please configure the system to a factory default environment, including OS, drivers and application installations.

To create a factory default image, please follow the steps below.

Step 1: Turn on the system. When the following screen displays (**Figure A-7**), press the <F3> key to access the recovery tool. The message will display for 10 seconds, please press F3 before the system boots into the operating system.

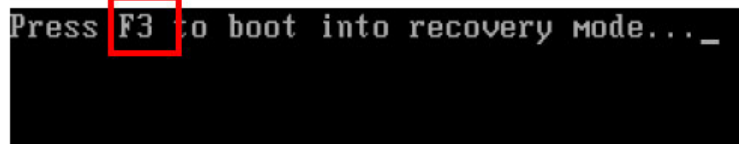

```
Press F3 to boot into recovery mode... _
```

Figure A-7: Press F3 to Boot into Recovery Mode

Step 2: The recovery tool menu appears. Type <4> and press <Enter>. (**Figure A-8**)

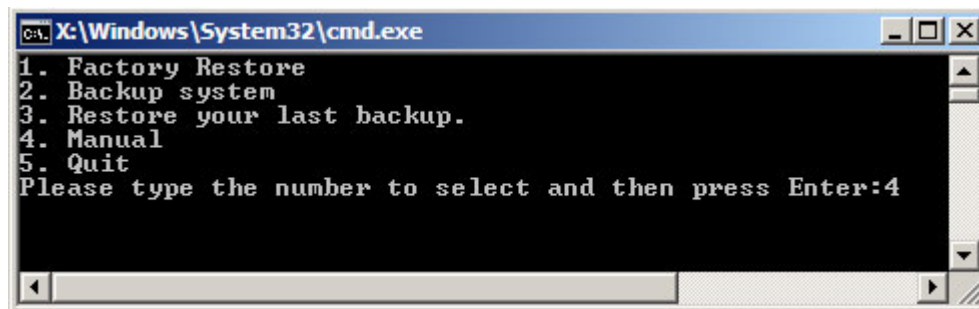

Figure A-8: Recovery Tool Menu

Step 3: The About Symantec Ghost window appears. Click **OK** button to continue.

TANK-GM45 Embedded System

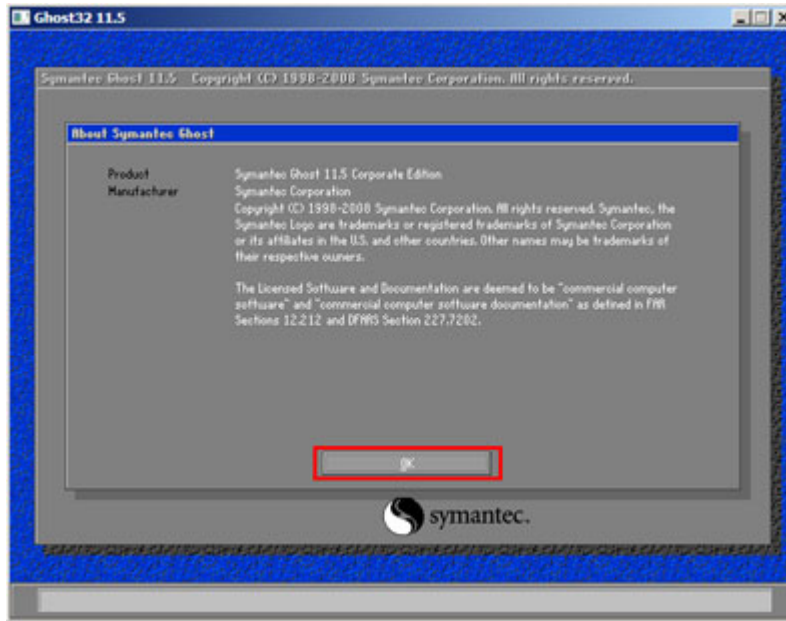

Figure A-9: About Symantec Ghost Window

Step 4: Use mouse to navigate to the option shown below (Figure A-10).

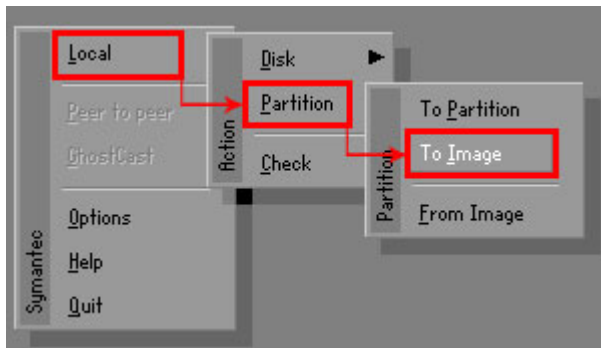

Figure A-10: Symantec Ghost Path

Step 5: Select the local source drive as shown in Figure A-11. Then click OK.

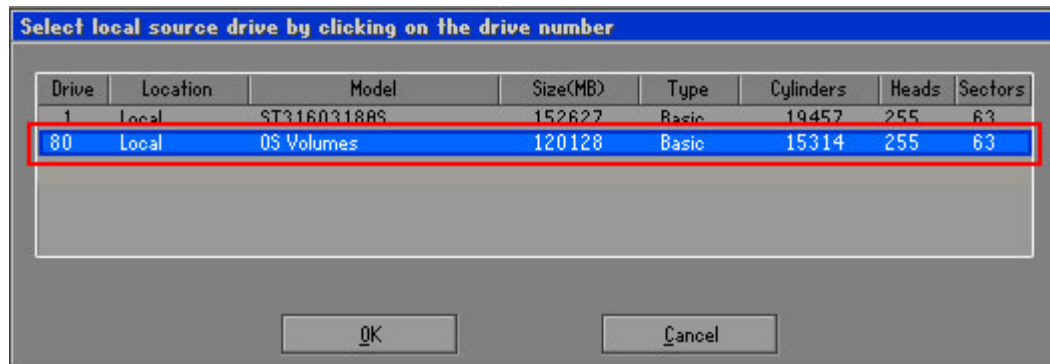

Figure A-11: Select a Local Source Drive

Step 6: Select a source partition from basic drive as shown in **Figure A-12**. Then click OK.

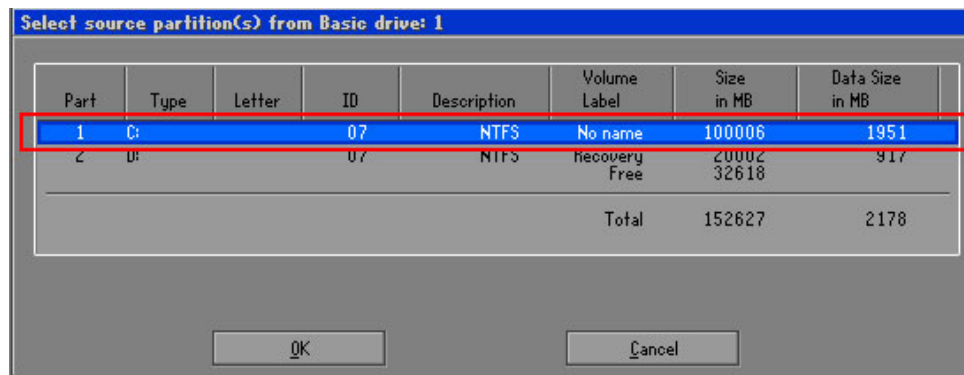

Figure A-12: Select a Source Partition from Basic Drive

Step 7: Select 1.2: **[Recovery] NTFS drive** and enter a file name called **iei** (**Figure A-13**). Click **Save**. The factory default image will then be saved in the selected recovery drive and named **IEI.GHO**.



WARNING:

The file name of the factory default image must be **iei.GHO**.

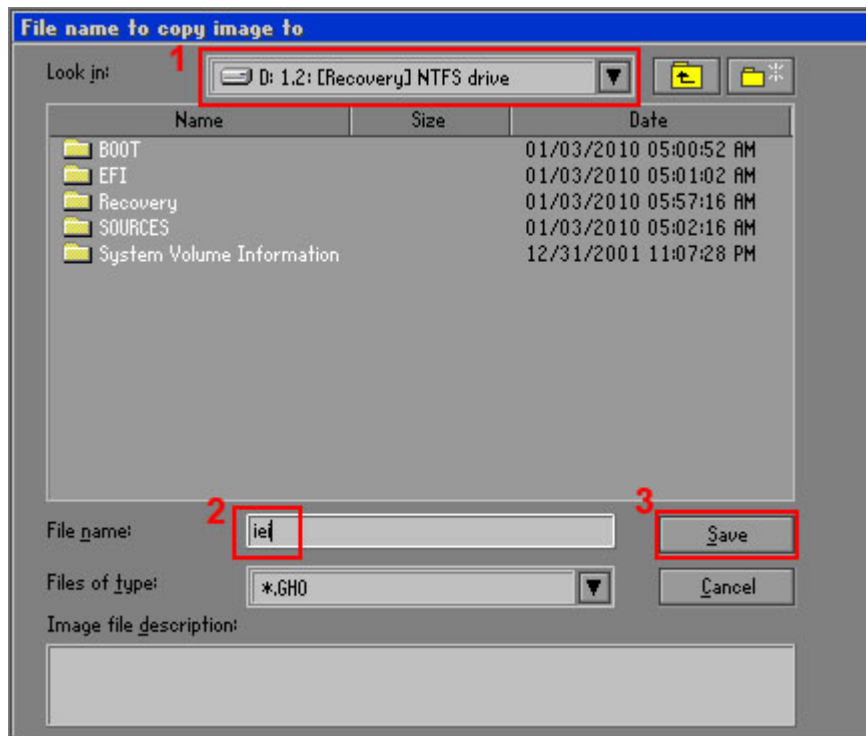

Figure A-13: File Name to Copy Image to

Step 8: When the Compress Image screen in **Figure A-14** prompts, click **High** to make the image file smaller.

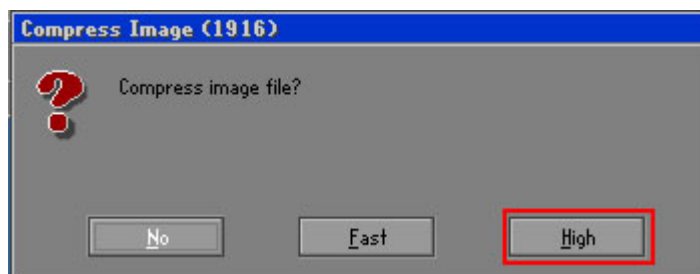

Figure A-14: Compress Image

Step 9: The Proceed with partition image creation window appears, click **Yes** to continue.

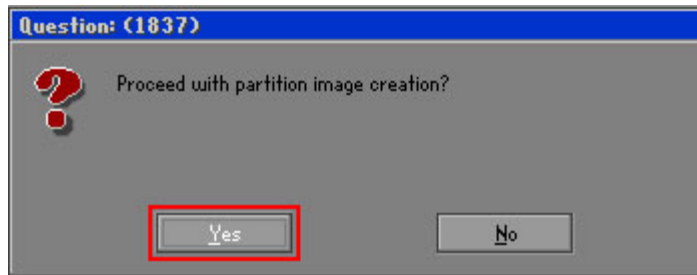

Figure A-15: Image Creation Confirmation

Step 10: The Symantec Ghost starts to create the factory default image (Figure A-16).

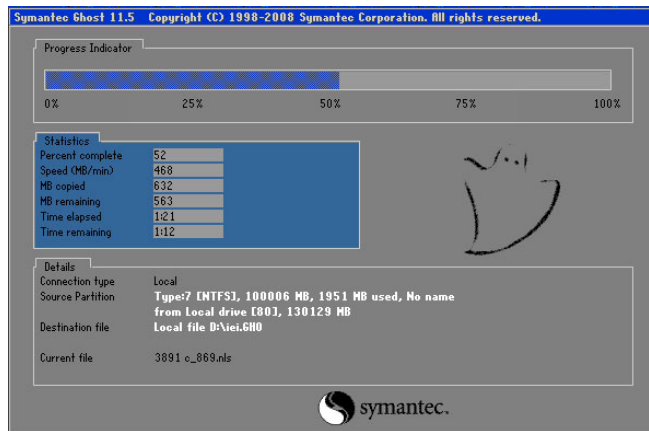

Figure A-16: Image Creation Complete

Step 11: When the image creation completes, a screen prompts as shown in Figure A-18.

Click **Continue** and close the Ghost window to exit the program.



Figure A-17: Image Creation Complete

TANK-GM45 Embedded System

Step 12: The recovery tool main menu window is shown as below. Press any key to reboot the system.

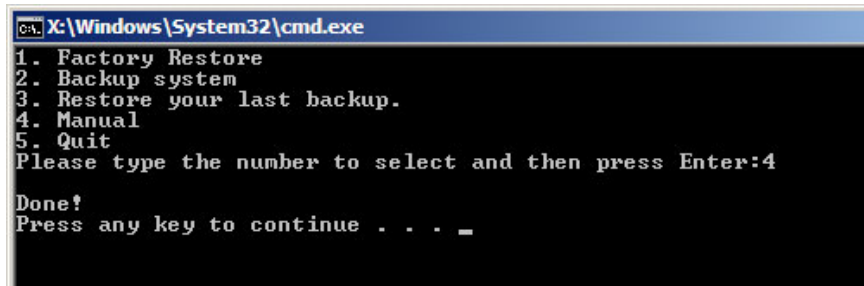

```
C:\Windows\System32\cmd.exe
1. Factory Restore
2. Backup system
3. Restore your last backup.
4. Manual
5. Quit
Please type the number to select and then press Enter:4
Done!
Press any key to continue . . . _
```

Figure A-18: Press Any Key to Continue

A.3 Initial Setup Procedure for Linux

The initial setup procedures for Linux system are mostly the same with the procedure for Microsoft Windows. Please follow the steps below to setup recovery tool for Linux OS.

Step 1: **Hardware and BIOS setup.** Refer to **Section A.2.1.**

Step 2: **Install Linux operating system.** Make sure to install GRUB (v0.97 or earlier) MBR type and Ext3 partition type.



NOTE:

If the Linux OS is not installed with GRUB (v0.97 or earlier) and Ext3, the Symantec Ghost may not function properly.

While installing Linux OS, please create two partitions:

- Partition 1: /
- Partition 2: **SWAP**



NOTE:

Please reserve enough space for partition 3 for saving recovery images.

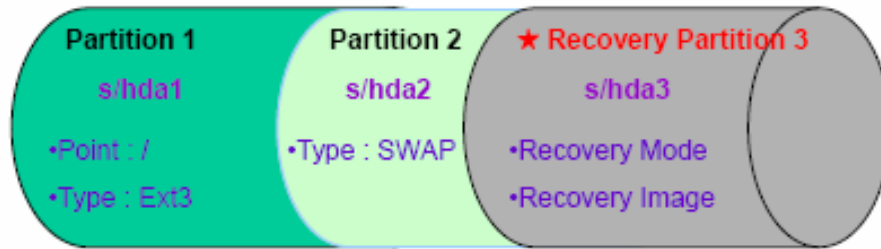

Figure A-19: Partitions for Linux

Step 3: Create a recovery partition. Insert the recovery CD into the optical disk drive.

Follow **Step 1 ~ Step 3** described in **Section A.2.2**. Then type the following commands (marked in red) to create a partition for recovery images.

```
system32>diskpart
DISKPART>list vol
DISKPART>sel disk 0
DISKPART>create part pri size= ____
DISKPART>assign letter=N
DISKPART>exit
system32>format N: /fs:ntfs /q /v:Recovery /y
system32>exit
```

Step 4: Build-up recovery partition. Press any key to boot from the recovery CD. It will take a while to launch the recovery tool. Please be patient. When the recovery tool setup menu appears, type <3> and press <Enter> (**Figure A-20**). The Symantec Ghost window appears and starts configuring the system to build-up a recovery partition. After completing the system configuration, press any key to reboot the system. Eject the recovery CD.

TANK-GM45 Embedded System

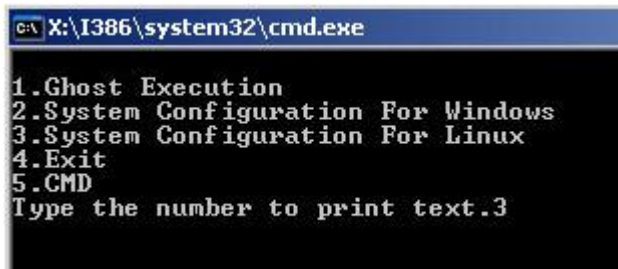

```
C:\X:\I386\system32\cmd.exe
1.Ghost Execution
2.System Configuration For Windows
3.System Configuration For Linux
4.Exit
5.CMD
Type the number to print text.3
```

Figure A-20: System Configuration for Linux

Step 5: Access the recovery tool main menu by modifying the “menu.lst”. To first access the recovery tool main menu, the menu.lst must be modified. In Linux system, enter Administrator (root). When prompt appears, type:

```
cd /boot/grub
```

```
vi menu.lst
```

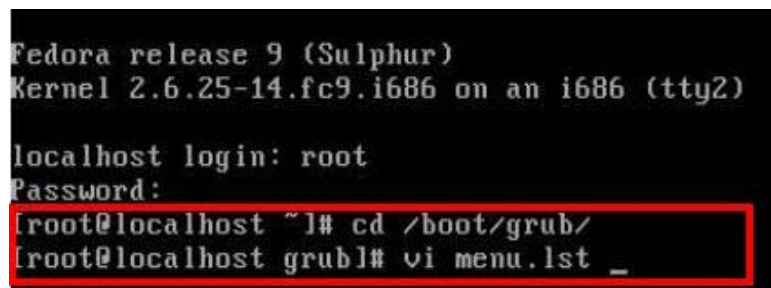

```
Fedora release 9 (Sulphur)
Kernel 2.6.25-14.fc9.i686 on an i686 (tty2)

localhost login: root
Password:
[root@localhost ~]# cd /boot/grub/
[root@localhost grub]# vi menu.lst _
```

Figure A-21: Access menu.lst in Linux (Text Mode)

Step 6: Modify the menu.lst as shown below.

```

#boot=/dev/sda
default=0
timeout=10 ← Modify timeout=10
splashimage=(hd0,0)/grub/splash.xpm.gz
hiddenmenu
title Fedora (2.6.25-14.fc9.i686)
    root (hd0,0)
    kernel /vmlinuz-2.6.25-14.fc9.i686 ro root=UUID=10f1acd
    ac38b5c78910 rhgb quiet
    initrd /initrd-2.6.25-14.fc9.i686.img

title Recovery Partition
    root (hd0,2)
    makeactive ← Type command
    chainloader +1
  
```

- Type command:
title Recovery Partition
root (hd0,2)
makeactive
chainloader +1

Step 7: The recovery tool menu appears. (Figure A-22)

```

1. Factory Restore
2. Backup system
3. Restore your last backup.
4. Manual
5. Quit
Please type the number to select and then press Enter:
  
```

Figure A-22: Recovery Tool Menu

Step 8: Create a factory default image. Follow **Step 2 ~ Step 12** described in **Section A.2.4** to create a factory default image.

A.4 Recovery Tool Functions

After completing the initial setup procedures as described above, users can access the recovery tool by pressing <F3> while booting up the system. The main menu of the recovery tool is shown below.

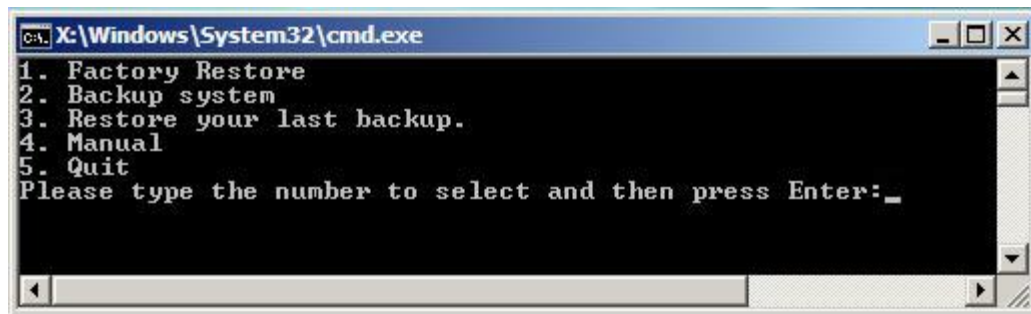

Figure A-23: Recovery Tool Main Menu

The recovery tool has several functions including:

1. **Factory Restore:** Restore the factory default image (iei.GHO) created in **Section A.2.4.**
2. **Backup system:** Create a system backup image (iei_user.GHO) which will be saved in the hidden partition.
3. **Restore your last backup:** Restore the last system backup image
4. **Manual:** Enter the Symantec Ghost window to configure manually.
5. **Quit:** Exit the recovery tool and restart the system.



WARNING:

Please do not turn off the system power during the process of system recovery or backup.



WARNING:

All data in the system will be deleted during the system recovery. Please backup the system files before restoring the system (either Factory Restore or Restore Backup).

A.4.1 Factory Restore

To restore the factory default image, please follow the steps below.

Step 1: Type <1> and press <Enter> in the main menu.

Step 2: The Symantec Ghost window appears and starts to restore the factory default. A factory default image called **iei.GHO** is created in the hidden Recovery partition.

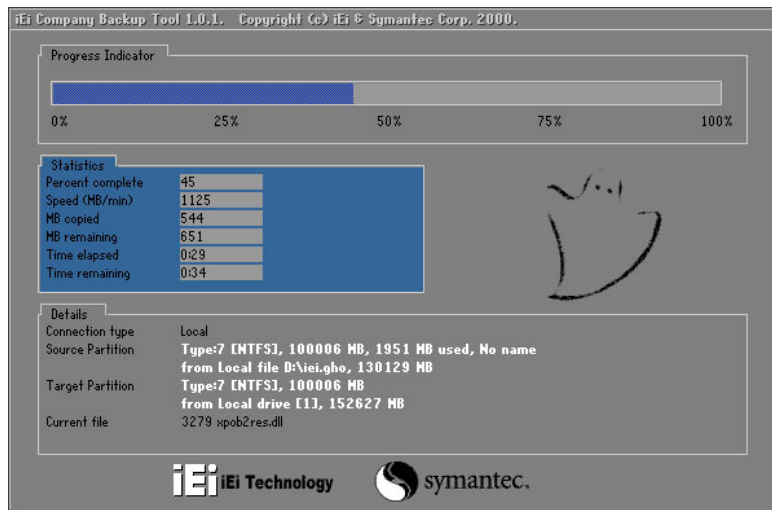

Figure A-24: Restore Factory Default

Step 3: The screen is shown as in **Figure A-25** when completed. Press any key to reboot the system.

TANK-GM45 Embedded System

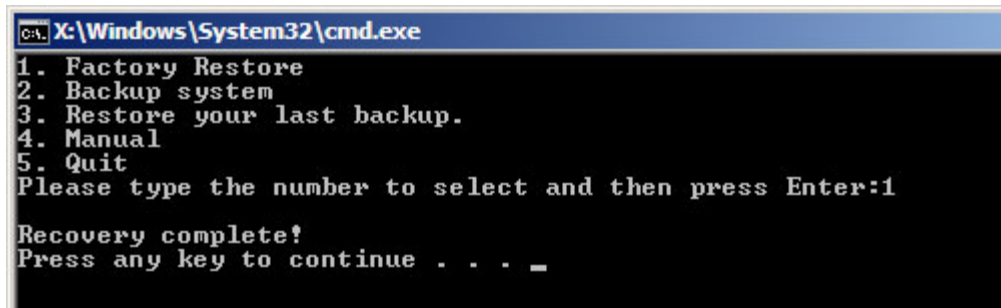

Figure A-25: Recovery Complete Window

A.4.2 Backup System

To backup the system, please follow the steps below.

Step 1: Type <2> and press <Enter> in the main menu.

Step 2: The Symantec Ghost window appears and starts to backup the system. A backup image called `iei_user.GHO` is created in the hidden Recovery partition.

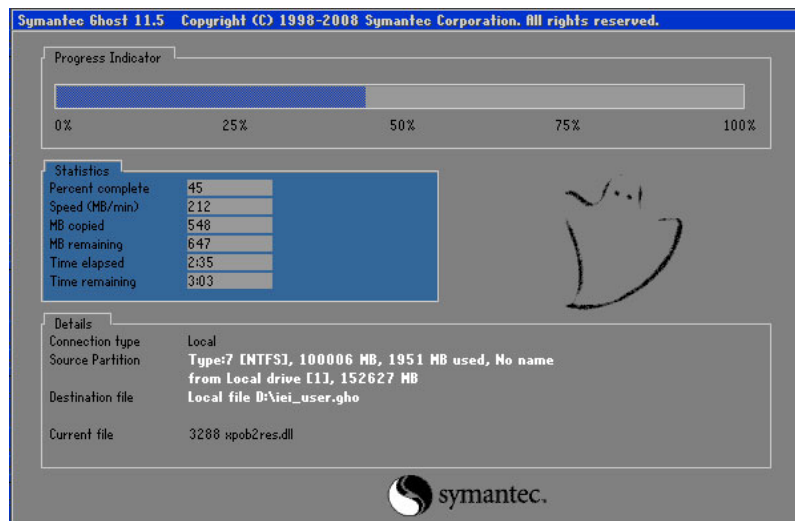

Figure A-26: Backup System

Step 3: The screen is shown as in **Figure A-25** when system backup is completed. Press any key to reboot the system.

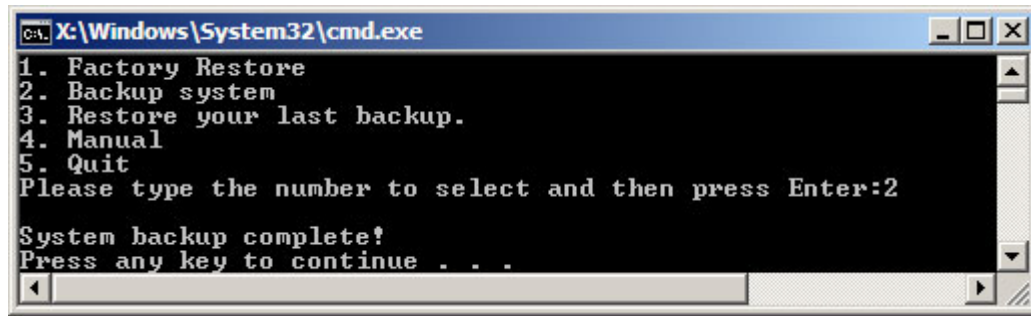

Figure A-27: System Backup Complete Window

A.4.3 Restore Your Last Backup

To restore the last system backup, please follow the steps below.

Step 1: Type <3> and press <Enter> in the main menu.

Step 2: The Symantec Ghost window appears and starts to restore the last backup image (iei_user.GHO).

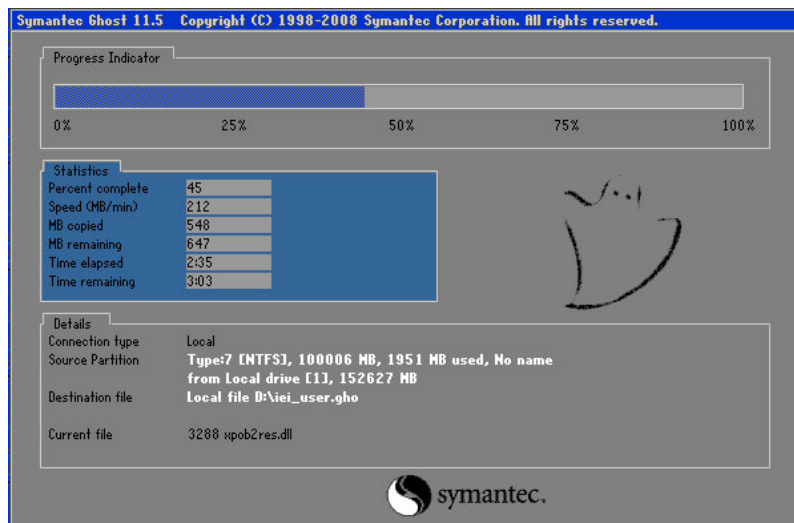

Figure A-28: Restore Backup

Step 3: The screen is shown as in **Figure A-25** when backup recovery is completed. Press any key to reboot the system.

TANK-GM45 Embedded System

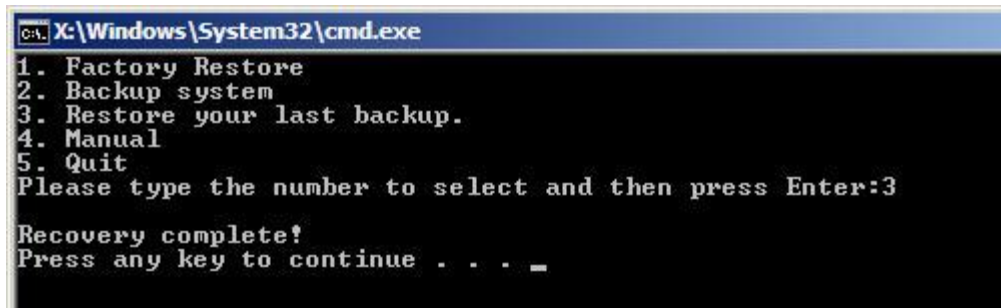

Figure A-29: Restore System Backup Complete Window

A.4.4 Manual

To restore the last system backup, please follow the steps below.

Step 1: Type <4> and press <Enter> in the main menu.

Step 2: The Symantec Ghost window appears. Use the Ghost program to backup or recover the system manually.

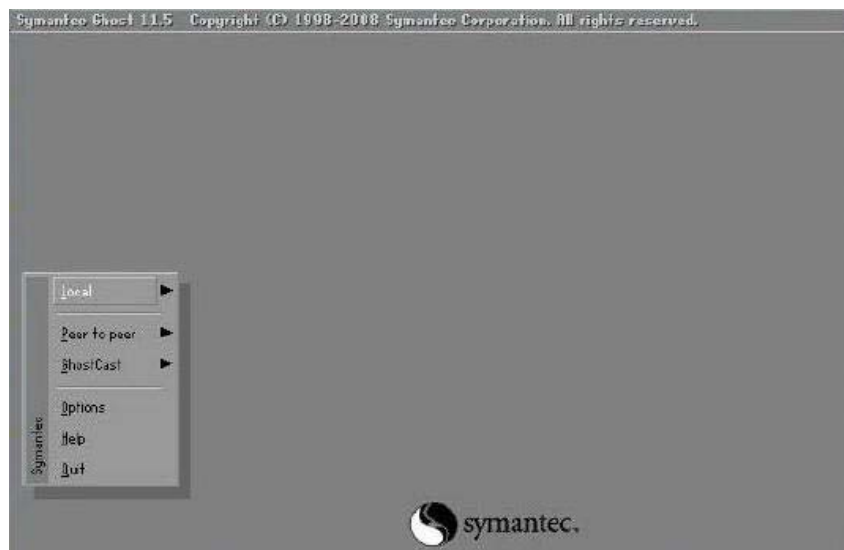

Figure A-30: Symantec Ghost Window

Step 3: When backup or recovery is completed, press any key to reboot the system.



Appendix

B

Safety Precautions

TANK-GM45 Embedded System

B.1 Safety Precautions



WARNING:

The precautions outlined in this appendix should be strictly followed. Failure to follow these precautions may result in permanent damage to the TANK-GM45.

Please follow the safety precautions outlined in the sections that follow:

B.1.1 General Safety Precautions

Please ensure the following safety precautions are adhered to at all times.

- ***Make sure the power is turned off and the power cord is disconnected*** when moving, installing or modifying the system.
- ***Do not apply voltage levels that exceed the specified voltage range.*** Doing so may cause fire and/or an electrical shock.
- ***Electric shocks can occur*** if opened while still powered on.
- ***Do not drop or insert any objects*** into the ventilation openings.
- ***If considerable amounts of dust, water, or fluids enter the system***, turn off the power supply immediately, unplug the power cord, and contact the system vendor.
- **DO NOT:**
 - Drop the system against a hard surface.
 - Strike or exert excessive force onto the LCD panel.
 - Touch any of the LCD panels with a sharp object
 - In a site where the ambient temperature exceeds the rated temperature

B.1.2 Anti-static Precautions



WARNING:

Failure to take ESD precautions during the installation of the TANK-GM45 may result in permanent damage to the TANK-GM45 and severe injury to the user.

Electrostatic discharge (ESD) can cause serious damage to electronic components, including the TANK-GM45. Dry climates are especially susceptible to ESD. It is therefore critical that whenever the TANK-GM45 is opened and any of the electrical components are handled, the following anti-static precautions are strictly adhered to.

- **Wear an anti-static wristband:** Wearing a simple anti-static wristband can help to prevent ESD from damaging any electrical component.
- **Self-grounding:** Before handling any electrical component, touch any grounded conducting material. During the time the electrical component is handled, frequently touch any conducting materials that are connected to the ground.
- **Use an anti-static pad:** When configuring or working with an electrical component, place it on an anti-static pad. This reduces the possibility of ESD damage.
- **Only handle the edges of the electrical component:** When handling the electrical component, hold the electrical component by its edges.

B.2 Maintenance and Cleaning Precautions

When maintaining or cleaning the TANK-GM45, please follow the guidelines below.

B.2.1 Maintenance and Cleaning

Prior to cleaning any part or component of the TANK-GM45, please read the details below.

- The interior of the TANK-GM45 does not require cleaning. Keep fluids away from the TANK-GM45 interior.

TANK-GM45 Embedded System

- Be cautious of all small removable components when vacuuming the TANK-GM45.
- Turn the TANK-GM45 off before cleaning the TANK-GM45.
- Never drop any objects or liquids through the openings of the TANK-GM45.
- Be cautious of any possible allergic reactions to solvents or chemicals used when cleaning the TANK-GM45.
- Avoid eating, drinking and smoking within vicinity of the TANK-GM45.

B.2.2 Cleaning Tools

Some components in the TANK-GM45 may only be cleaned using a product specifically designed for the purpose. In such case, the product will be explicitly mentioned in the cleaning tips. Below is a list of items to use when cleaning the TANK-GM45.

- **Cloth** – Although paper towels or tissues can be used, a soft, clean piece of cloth is recommended when cleaning the TANK-GM45.
- **Water or rubbing alcohol** – A cloth moistened with water or rubbing alcohol can be used to clean the TANK-GM45.
- **Using solvents** – The use of solvents is not recommended when cleaning the TANK-GM45 as they may damage the plastic parts.
- **Vacuum cleaner** – Using a vacuum specifically designed for computers is one of the best methods of cleaning the TANK-GM45. Dust and dirt can restrict the airflow in the TANK-GM45 and cause its circuitry to corrode.
- **Cotton swabs** - Cotton swabs moistened with rubbing alcohol or water are excellent tools for wiping hard to reach areas.
- **Foam swabs** - Whenever possible, it is best to use lint free swabs such as foam swabs for cleaning.



Appendix

C

Hazardous Materials Disclosure

C.1 Hazardous Materials Disclosure Table for IPB Products Certified as RoHS Compliant Under 2002/95/EC Without Mercury

The details provided in this appendix are to ensure that the product is compliant with the Peoples Republic of China (China) RoHS standards. The table below acknowledges the presences of small quantities of certain materials in the product, and is applicable to China RoHS only.

A label will be placed on each product to indicate the estimated “Environmentally Friendly Use Period” (EFUP). This is an estimate of the number of years that these substances would “not leak out or undergo abrupt change.” This product may contain replaceable sub-assemblies/components which have a shorter EFUP such as batteries and lamps. These components will be separately marked.

Please refer to the table on the next page.

| Part Name | Toxic or Hazardous Substances and Elements | | | | | |
|--------------------------------|--|--------------|--------------|------------------------------|--------------------------------|---------------------------------------|
| | Lead (Pb) | Mercury (Hg) | Cadmium (Cd) | Hexavalent Chromium (CR(VI)) | Polybrominated Biphenyls (PBB) | Polybrominated Diphenyl Ethers (PBDE) |
| Housing | X | O | O | O | O | X |
| Display | X | O | O | O | O | X |
| Printed Circuit Board | X | O | O | O | O | X |
| Metal Fasteners | X | O | O | O | O | O |
| Cable Assembly | X | O | O | O | O | X |
| Fan Assembly | X | O | O | O | O | X |
| Power Supply Assemblies | X | O | O | O | O | X |
| Battery | O | O | O | O | O | O |

O: This toxic or hazardous substance is contained in all of the homogeneous materials for the part is below the limit requirement in SJ/T11363-2006

X: This toxic or hazardous substance is contained in at least one of the homogeneous materials for this part is above the limit requirement in SJ/T11363-2006

TANK-GM45 Embedded System

此附件旨在确保本产品符合中国 RoHS 标准。以下表格标示此产品中某有毒物质的含量符合中国 RoHS 标准规定的限量要求。

本产品上会附有“环境友好使用期限”的标签，此期限是估算这些物质“不会有泄漏或突变”的年限。本产品可能包含有较短的环境友好使用期限的可替换元件，像是电池或灯管，这些元件将会单独标示出来。

| 部件名称 | 有毒有害物质或元素 | | | | | |
|--------|-----------|-----------|-----------|-----------------|---------------|---------------------|
| | 铅 (Pb) | 汞 (Hg) | 镉 (Cd) | 六价铬 (CR(VI)) | 多溴联苯 (PBB) | 多溴二苯 醚 (PBDE) |
| 壳体 | X | O | O | O | O | X |
| 显示 | X | O | O | O | O | X |
| 印刷电路板 | X | O | O | O | O | X |
| 金属螺帽 | X | O | O | O | O | O |
| 电缆组装 | X | O | O | O | O | X |
| 风扇组装 | X | O | O | O | O | X |
| 电力供应组装 | X | O | O | O | O | X |
| 电池 | O | O | O | O | O | O |

O: 表示该有毒有害物质在该部件所有物质材料中的含量均在 SJ/T11363-2006 标准规定的限量要求以下。
X: 表示该有毒有害物质至少在该部件的某一均质材料中的含量超出 SJ/T11363-2006 标准规定的限量要求。