



IEI Technology Corp.



MODEL:
ECN-360A-D2550

Embedded System with Intel® dual core Atom™ D2550 Processor,
Two VGA, Six USB 2.0, Four COM,
GbE and RoHS Compliant

User Manual

Rev. 1.00 – 1 July 2013



Revision

Date	Version	Changes
1 July 2013	1.00	Initial release

Copyright

COPYRIGHT NOTICE

The information in this document is subject to change without prior notice in order to improve reliability, design and function and does not represent a commitment on the part of the manufacturer.

In no event will the manufacturer be liable for direct, indirect, special, incidental, or consequential damages arising out of the use or inability to use the product or documentation, even if advised of the possibility of such damages.

This document contains proprietary information protected by copyright. All rights are reserved. No part of this manual may be reproduced by any mechanical, electronic, or other means in any form without prior written permission of the manufacturer.

TRADEMARKS

All registered trademarks and product names mentioned herein are used for identification purposes only and may be trademarks and/or registered trademarks of their respective owners.

Table of Contents

1 INTRODUCTION.....	1
1.1 OVERVIEW.....	2
1.2 MODEL VARIATIONS	2
1.3 FEATURES.....	2
1.4 TECHNICAL SPECIFICATIONS	3
1.5 FRONT PANEL.....	4
1.6 REAR PANEL.....	5
1.7 DIMENSIONS.....	7
2 UNPACKING	8
2.1 ANTI-STATIC PRECAUTIONS	9
2.2 UNPACKING PRECAUTIONS.....	9
2.3 UNPACKING CHECKLIST	10
3 INSTALLATION	12
3.1 INSTALLATION PRECAUTIONS	13
3.2 INSTALLATION AND CONFIGURATION STEPS	13
3.3 HARD DISK DRIVE (HDD) INSTALLATION.....	13
3.4 WI-FI ANTENNA INSTALLATION (WIRELESS MODEL ONLY)	15
3.5 MOUNT THE SYSTEM.....	16
3.6 EXTERNAL PERIPHERAL INTERFACE CONNECTORS.....	17
3.6.1 Audio Connection.....	17
3.6.2 LAN Connection.....	18
3.6.3 DB-9 Serial Port Connection.....	19
3.6.4 USB Device Connection.....	20
3.6.5 VGA Monitor Connection	21
4 SYSTEM MOTHERBOARD	23
4.1 PERIPHERAL INTERFACE CONNECTORS.....	24
4.1.1 Layout	24
4.1.2 Peripheral Interface Connectors	24

4.1.3 External Interface Panel Connectors.....	25
4.2 INTERNAL PERIPHERAL CONNECTORS	26
4.2.1 5 V SATA Power Connectors.....	26
4.2.2 Audio Connector	26
4.2.3 Backlight Inverter Connector	27
4.2.4 Battery Connector.....	28
4.2.5 Digital Input/Output (DIO) Connector.....	29
4.2.6 Fan Connectors.....	30
4.2.7 Front Panel Connector	31
4.2.8 Keyboard/Mouse Connector	31
4.2.9 LVDS1 Connector	32
4.2.10 PCIe Mini Card Slots.....	33
4.2.11 Power Connector (9V~28V).....	35
4.2.12 RS-232 Serial Port Connectors.....	36
4.2.13 RS-422/485 Serial Port Connector	37
4.2.14 SATA Drive Connectors	37
4.2.15 SO-DIMM Connector.....	38
4.2.16 USB Connector	39
4.3 EXTERNAL PERIPHERAL INTERFACE CONNECTOR PANEL	40
4.3.1 Ethernet Connectors	40
4.3.2 USB Connectors.....	41
4.3.3 VGA Connectors	42
4.4 JUMPER SETTINGS	43
4.4.1 AT/ATX Power Selection Jumper.....	43
4.4.2 Clear CMOS Jumper.....	44
4.4.3 LVDS1 Voltage Selection.....	45
4.4.4 mSATA/PCIe Mini Selection	46
5 BIOS.....	47
5.1 INTRODUCTION.....	48
5.1.1 Starting Setup.....	48
5.1.2 Using Setup	48
5.1.3 Getting Help.....	49
5.1.4 Unable to Reboot after Configuration Changes	49
5.1.5 BIOS Menu Bar.....	49

5.2 MAIN.....	50
5.3 ADVANCED.....	51
5.3.1 ACPI Settings.....	51
5.3.2 RTC Wake Settings.....	52
5.3.3 CPU Configuration.....	54
5.3.4 IDE Configuration.....	55
5.3.5 USB Configuration.....	56
5.3.6 F81866 Super IO Configuration.....	57
5.3.6.1 Serial Port n Configuration.....	58
5.3.7 F81866 H/W Monitor.....	62
5.3.7.1 Smart Fan Mode Configuration.....	63
5.3.8 Serial Port Console Redirection.....	64
5.3.9 iEi Feature.....	66
5.4 CHIPSET.....	67
5.4.1 Host Bridge Configuration.....	67
5.4.1.1 Intel IGD Configuration.....	68
5.4.2 South Bridge Configuration.....	70
5.5 BOOT.....	71
5.6 SECURITY.....	73
5.7 SAVE & EXIT.....	73
A SAFETY PRECAUTIONS.....	75
A.1 SAFETY PRECAUTIONS.....	76
A.1.1 General Safety Precautions.....	76
A.1.2 Anti-static Precautions.....	77
A.1.3 Product Disposal.....	78
A.2 MAINTENANCE AND CLEANING PRECAUTIONS.....	78
A.2.1 Maintenance and Cleaning.....	78
A.2.2 Cleaning Tools.....	79
B BIOS MENU OPTIONS.....	80
C ONE KEY RECOVERY.....	83
C.1 ONE KEY RECOVERY INTRODUCTION.....	84
C.1.1 System Requirement.....	85
C.1.2 Supported Operating System.....	86

C.2 SETUP PROCEDURE FOR WINDOWS	87
C.2.1 Hardware and BIOS Setup	88
C.2.2 Create Partitions	88
C.2.3 Install Operating System, Drivers and Applications.....	92
C.2.4 Building the Recovery Partition.....	93
C.2.5 Create Factory Default Image	95
C.3 AUTO RECOVERY SETUP PROCEDURE.....	100
C.4 SETUP PROCEDURE FOR LINUX	104
C.5 RECOVERY TOOL FUNCTIONS	108
C.5.1 Factory Restore	109
C.5.2 Backup System.....	110
C.5.3 Restore Your Last Backup.....	111
C.5.4 Manual	112
C.6 RESTORE SYSTEMS FROM A LINUX SERVER THROUGH LAN	113
C.6.1 Configure DHCP Server Settings.....	114
C.6.2 Configure TFTP Settings.....	115
C.6.3 Configure One Key Recovery Server Settings.....	116
C.6.4 Start the DHCP, TFTP and HTTP	117
C.6.5 Create Shared Directory.....	117
C.6.6 Setup a Client System for Auto Recovery	118
C.7 OTHER INFORMATION	121
C.7.1 Using AHCI Mode or ALi M5283 / VIA VT6421A Controller	121
C.7.2 System Memory Requirement	123
D WATCHDOG TIMER	124
E HAZARDOUS MATERIALS DISCLOSURE	127
E.1 HAZARDOUS MATERIALS DISCLOSURE TABLE FOR IPB PRODUCTS CERTIFIED AS ROHS COMPLIANT UNDER 2002/95/EC WITHOUT MERCURY	128

List of Figures

Figure 1-1: ECN-360A-D2550	2
Figure 1-2: ECN-360A-D2550 Front Panel	5
Figure 1-3: ECN-360A-D2550 Rear Panel	6
Figure 1-4: Physical Dimensions (mm)	7
Figure 3-1: Retention Screws Removal	14
Figure 3-2: HDD Bracket	14
Figure 3-3: HDD Retention Screws	15
Figure 3-4: Wi-Fi Antenna Installation	16
Figure 3-5: Mounting Bracket Retention Screws	16
Figure 3-6: Audio Connector	18
Figure 3-7: LAN Connection	19
Figure 3-8: DB-9 Serial Port Connector	20
Figure 3-10: USB Device Connection	21
Figure 3-11: VGA Connector	22
Figure 4-1: Connectors and Jumpers	24
Figure 4-2: 5 V SATA Power Connector Locations	26
Figure 4-3: Audio Connector Location	27
Figure 4-4: Backlight Inverter Connector Location	28
Figure 4-5: Battery Connector Location	29
Figure 4-6: Digital I/O Connector Location	29
Figure 4-7: Fan Connector Locations	30
Figure 4-8: Front Panel Connector Location	31
Figure 4-9: Keyboard/Mouse Connector Location	32
Figure 4-10: LVDS1 Connector Location	33
Figure 4-11: PCIe Mini Card Slot Locations	34
Figure 4-12: Power Connector Location	35
Figure 4-13: RS-232 Serial Port Connector Locations	36
Figure 4-14: RS-422/485 Connector Location	37
Figure 4-15: SATA Drive Connector Locations	38
Figure 4-16: SO-DIMM Connector Location	39

Figure 4-17: USB Connector Location.....	39
Figure 4-18: External Peripheral Interface Connector	40
Figure 4-19: RJ-45 Ethernet Connector.....	41
Figure 4-20: VGA Connector	42
Figure 4-21: AT/ATX Power Selection Jumper Location	44
Figure 4-22: Clear CMOS Jumper Location	45
Figure 4-23: LVDS1 Voltage Selection Jumper Location	46
Figure 4-24: mSATA/PCIe Mini Mode Selection Jumper Location	46
Figure C-1: IEI One Key Recovery Tool Menu	84
Figure C-2: Launching the Recovery Tool	89
Figure C-3: Recovery Tool Setup Menu	89
Figure C-4: Command Prompt	90
Figure C-5: Partition Creation Commands.....	91
Figure C-6: Launching the Recovery Tool	93
Figure C-7: Manual Recovery Environment for Windows	93
Figure C-8: Building the Recovery Partition.....	94
Figure C-9: Press Any Key to Continue	94
Figure C-10: Press F3 to Boot into Recovery Mode.....	95
Figure C-11: Recovery Tool Menu	95
Figure C-12: About Symantec Ghost Window.....	96
Figure C-13: Symantec Ghost Path	96
Figure C-14: Select a Local Source Drive	97
Figure C-15: Select a Source Partition from Basic Drive	97
Figure C-16: File Name to Copy Image to	98
Figure C-17: Compress Image.....	98
Figure C-18: Image Creation Confirmation	99
Figure C-19: Image Creation Complete	99
Figure C-20: Image Creation Complete	99
Figure C-21: Press Any Key to Continue	100
Figure C-22: Auto Recovery Utility	101
Figure C-23: Launching the Recovery Tool.....	101
Figure C-24: Auto Recovery Environment for Windows	101
Figure C-25: Building the Auto Recovery Partition.....	102
Figure C-26: Factory Default Image Confirmation	102
Figure C-27: Image Creation Complete	103

Figure C-28: Press any key to continue	103
Figure C-29: Partitions for Linux.....	105
Figure C-30: Manual Recovery Environment for Linux	106
Figure C-31: Access menu.lst in Linux (Text Mode).....	107
Figure C-32: Recovery Tool Menu	107
Figure C-33: Recovery Tool Main Menu	108
Figure C-34: Restore Factory Default	109
Figure C-35: Recovery Complete Window	110
Figure C-36: Backup System.....	110
Figure C-37: System Backup Complete Window	111
Figure C-38: Restore Backup	111
Figure C-39: Restore System Backup Complete Window	112
Figure C-40: Symantec Ghost Window	112

List of Tables

Table 1-1: Model Variations	2
Table 1-2: Technical Specifications	4
Table 2-1: Package List Contents	11
Table 4-1: Peripheral Interface Connectors	25
Table 4-2: Rear Panel Connectors	25
Table 4-3: 5 V SATA Power Connector Pinouts	26
Table 4-4: Audio Connector Pinouts	27
Table 4-5: Backlight Inverter Connector Pinouts	28
Table 4-6: Battery Connector Pinouts	29
Table 4-7: Digital I/O Connector Pinouts	30
Table 4-8: Fan Connector Pinouts	30
Table 4-9: Front Panel Connector Pinouts	31
Table 4-10: Keyboard/Mouse Connector Pinouts	32
Table 4-11: LVDS1 Connector Pinouts	33
Table 4-12: PCIe Mini Card Slot Pinouts	35
Table 4-13: Power Connector Pinouts	36
Table 4-14: RS-232 Serial Port Connector Pinouts	36
Table 4-15: RS-422/485 Connector Pinouts	37
Table 4-16: SATA Drive Connector Pinouts	38
Table 4-17: USB Connector Pinouts	39
Table 4-18: LAN Pinouts	40
Table 4-19: RJ-45 Ethernet Connector LEDs	41
Table 4-20: USB Port Pinouts	41
Table 4-21: VGA Connector Pinouts	42
Table 4-22: Jumpers	43
Table 4-23: AT/ATX Power Selection Jumper Settings	44
Table 4-24: Clear CMOS Jumper Settings	44
Table 4-25: LVDS1 Voltage Selection Jumper Settings	45
Table 4-26: mSATA/PCIe Mini Mode Selection Jumper Settings	46
Table 5-1: BIOS Navigation Keys	49

Chapter

1

Introduction

1.1 Overview



Figure 1-1: ECN-360A-D2550

The ECN-360A-D2550 embedded system is a fanless system with two VGA ports for dual display. It is powered by Intel® dual core Atom™ D2550 processor and supports one 204-pin DDR3 SDRAM SO-DIMM module up to 4 GB (2GB memory preinstalled). The ECN-360A-D2550 supports a 2.5" SATA HDD with up to 3 Gb/s data transfer rate. Four serial ports and six USB 2.0 ports ensure simplified connectivity to a variety of external peripheral devices.

1.2 Model Variations

The model variations of the ECN-360A-D2550 series are listed below.

Models	Wireless
ECN-360A-D2550/2G-R10	N/A
ECN-360AW-D2550/2G-R10	802.11b/g/n

Table 1-1: Model Variations

1.3 Features

The ECN-360A-D2550 features are listed below:

- ECN-360A-D2550: Intel® Atom™ D2550 dual core 1.86 GHz
- Rich video output solution: ECN-360A-D2550: 2 x VGA
- Ruggedized embedded computer: support -10°C~60°C with air flow (SSD)

1.4 Technical Specifications

The ECN-360A-D2550 technical specifications are listed in **Table 1-1**.

Chassis	
Color	Black
Dimension (WxDxH)	255 x 130 x 63
System Fan	Fanless
Chassis Construction	SECC
Motherboard	
Motherboard model	NANO-CV-D25502
CPU	Intel® dual core Atom™ D2550 1.86GHz
Chipset	Intel® NM10
System Memory	1 x 204-pin DDR3 SDRAM SO-DIMM (System Max : 4GB) Pre-installed DDR3 2GB memory
Ethernet	2 x Realtek RTL8111E PCIe GbE controller
Storage	
Hard Drive	1 x 2.5" SATA HDD Bay
I/O interfaces	
USB	6 x USB 2.0
LAN	2 x RJ-45 LAN
RS-232	3 x RS-232 (DB-9 connector)
RS-422/485	1 x RS-422/485 (DB-9 connector)
Digital I/O	1 x DB-9 ; 8 bit Digital I/O , 4 bit input / 4 bit output
Display	2 x VGA
Resolution	VGA: Up to 1920 x 1200 @ 60Hz
Audio	1 x Line-out
Wireless	1 x 802.11 b/g/n (optional)
Expansions	

PCIe Mini	1 x Full size (support mSATA) 1 x Half size
Power	
Power Input	9~28V DC Power 1 : DC Jack Power 2: Terminal block
Power Consumption	12V@1.59A (Intel® Atom™ D2550 with 2GB DDR3 memory)
Reliability	
Mounting	Wall mount ; VESA 100
Operating Temperature	-10°C~55°C with air flow (SSD) 0°C~45°C with air flow (HDD)
Storage Temperature	-20°C ~ 60°C
Operating Shock	Half-sine wave shock 3G; 11ms; 3 shocks per axis
Operating Vibration	MIL-STD-810F 514.5C-1
Weight (Net/Gross)	2.2 kg / 3 kg
Safety / EMC	CE / FCC Class A
OS	
Supported OS	Microsoft® WES7E Microsoft® Windows® XP Embedded

Table 1-2: Technical Specifications

1.5 Front Panel

The front panel of the ECN-360A-D2550 has the following features (**Figure 1-2**):

- 1 x HDD LED
- 1 x Power button
- 2 x USB 2.0 connectors



Figure 1-2: ECN-360A-D2550 Front Panel

1.6 Rear Panel

The rear panel of the ECN-360A-D2550 has the following features (**Figure 1-3**):

- 1 x Line-out
- 1 x 9 V ~ 28 V power jack
- 1 x Reset button
- 2 x RJ-45 LAN connectors
- 3 x RS-232 (DB-9 connector)
- 1 x RS-422/485 (DB-9 connector)
- 1 x 9 V ~ 28 V terminal block
- 4 x USB 2.0 connectors
- 2 x VGA connectors
- 2 x WiFi antenna connectors

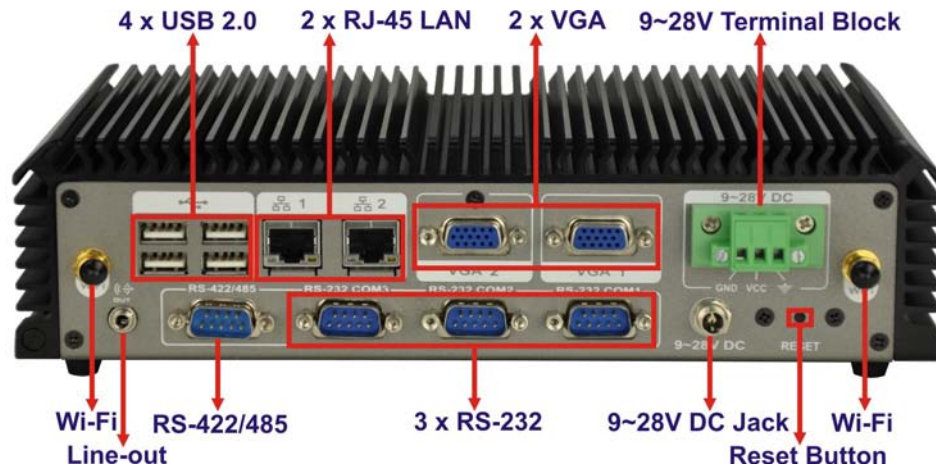

Figure 1-3: ECN-360A-D2550 Rear Panel

1.7 Dimensions

The physical dimensions are shown below:

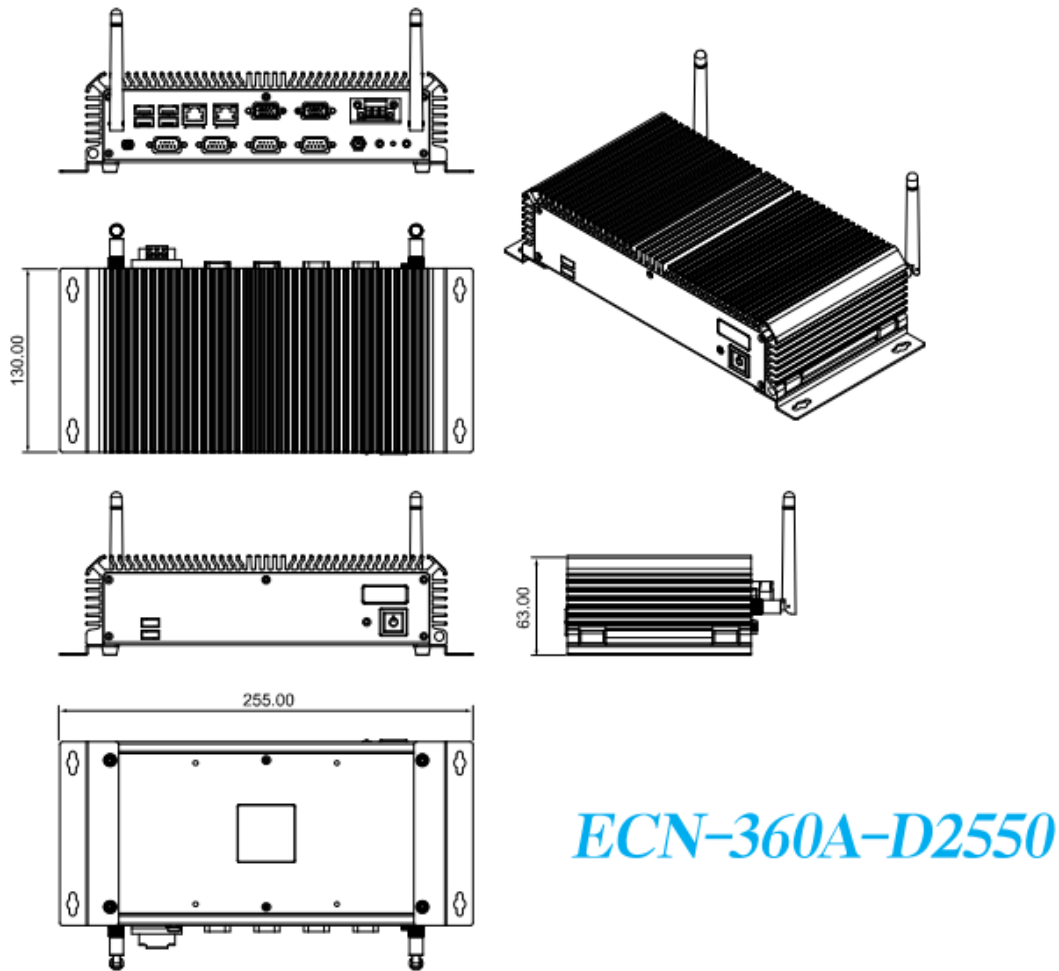

Figure 1-4: Physical Dimensions (mm)



Chapter

2

Unpacking

2.1 Anti-static Precautions



WARNING:

Failure to take ESD precautions during installation may result in permanent damage to the ECN-360A-D2550 and severe injury to the user.

Electrostatic discharge (ESD) can cause serious damage to electronic components, including the ECN-360A-D2550. Dry climates are especially susceptible to ESD. It is therefore critical that whenever the ECN-360A-D2550 or any other electrical component is handled, the following anti-static precautions are strictly adhered to.

- ***Wear an anti-static wristband:*** Wearing a simple anti-static wristband can help to prevent ESD from damaging the board.
- ***Self-grounding:*** Before handling the board, touch any grounded conducting material. During the time the board is handled, frequently touch any conducting materials that are connected to the ground.
- ***Use an anti-static pad:*** When configuring the ECN-360A-D2550, place it on an anti-static pad. This reduces the possibility of ESD damaging the ECN-360A-D2550.

2.2 Unpacking Precautions

When the ECN-360A-D2550 is unpacked, please do the following:

- Follow the anti-static precautions outlined in **Section 2.1**.
- Make sure the packing box is facing upwards so the ECN-360A-D2550 does not fall out of the box.
- Make sure all the components shown in **Section 2.3** are present.







2.3 Unpacking Checklist



NOTE:

If some of the components listed in the checklist below are missing, please do not proceed with the installation. Contact the IEI reseller or vendor you purchased the ECN-360A-D2550 from or contact an IEI sales representative directly. To contact an IEI sales representative, please send an email to sales@iei.com.tw.

The ECN-360A-D2550 is shipped with the following components:

Quantity	Item and Part Number	Image
1	ECN-360A-D2550	
1	power adapter	
1	power cord	
2	Mounting brackets	
1	Screw set	
2	wireless antenna (for wireless model)	



Quantity	Item and Part Number	Image
1	Utility CD	 A CD-ROM with a white label featuring the iEi logo and some text.
1	One Key Recovery CD	 A CD-ROM with a white label featuring the iEi logo and the text 'One Key Recovery'.

Table 2-1: Package List Contents

Chapter

3

Installation

3.1 Installation Precautions

During installation, be aware of the precautions below:

- **Read the user manual:** The user manual provides a complete description of the ECN-360A-D2550, installation instructions and configuration options.
- **DANGER! Disconnect Power:** Power to the ECN-360A-D2550 must be disconnected during the installation process, or before any attempt is made to access the rear panel. Electric shock and personal injury might occur if the rear panel of the ECN-360A-D2550 is opened while the power cord is still connected to an electrical outlet.
- **Qualified Personnel:** The ECN-360A-D2550 must be installed and operated only by trained and qualified personnel. Maintenance, upgrades, or repairs may only be carried out by qualified personnel who are familiar with the associated dangers.
- **Grounding:** The ECN-360A-D2550 should be properly grounded. The voltage feeds must not be overloaded. Adjust the cabling and provide external overcharge protection per the electrical values indicated on the label attached to the back of the ECN-360A-D2550.

3.2 Installation and Configuration Steps

The following installation steps must be followed.

- Step 1:** Unpack the ECN-360A-D2550.
- Step 2:** Install the HDD.
- Step 3:** Install the Wi-Fi antenna (Wi-Fi model only).
- Step 4:** Configure the system.
- Step 5:** Connect peripheral devices to the ECN-360A-D2550.
- Step 6:** Mount the ECN-360A-D2550.

3.3 Hard Disk Drive (HDD) Installation

To install the hard drive, please follow the steps below:

Step 1: Remove six retention screws from the bottom panel (Figure 3-1).

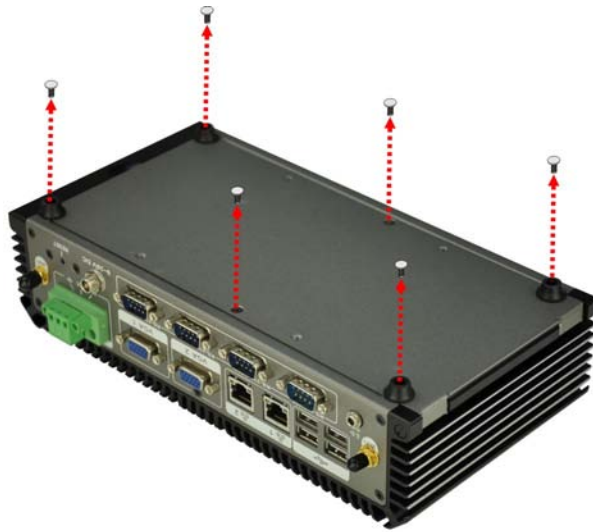

Figure 3-1: Retention Screws Removal

Step 2: Open the bottom panel and locate the HDD bracket (Figure 3-2).



Figure 3-2: HDD Bracket

ECN-360A-D2550 Embedded System

Step 3: Attach the HDD to the HDD bracket, and then slide the HDD to connect the HDD to the SATA connector. Secure the HDD with the HDD bracket by four retention screws (**Figure 3-3**).



Figure 3-3: HDD Retention Screws

Step 4: Replace the HDD cover and secure it using six previously removed retention screws.

3.4 Wi-Fi Antenna Installation (Wireless Model Only)

To install the Wi-Fi antennas to the ECN-360A-D2550 series for efficient wireless network transmission, follow the steps below.

Step 1: Locate the antenna connectors on the rear panel of the embedded system.

Step 2: Install the antennas to the antenna connectors (**Figure 3-4**).



Figure 3-4: Wi-Fi Antenna Installation

3.5 Mount the System

To mount the embedded system onto a wall or some other surface using the two mounting brackets, please follow the steps below.

- Step 1:** Turn the embedded system over.
- Step 2:** Align the two retention screw holes in each bracket with the corresponding retention screw holes on the sides of the bottom surface.
- Step 3:** Secure the brackets to the system by inserting two retention screws into each bracket as illustrated in **Figure 3-5**.

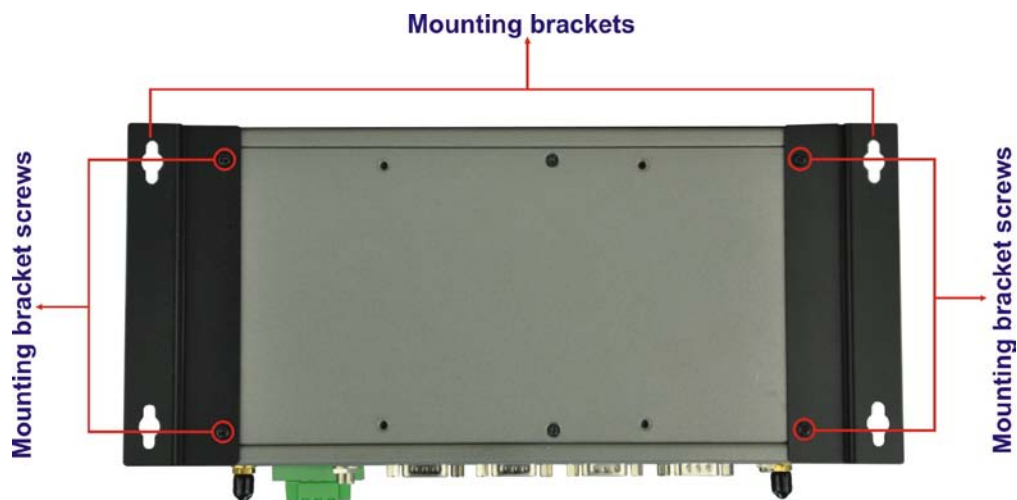

Figure 3-5: Mounting Bracket Retention Screws

- Step 4:** Drill holes in the intended installation surface.

ECN-360A-D2550 Embedded System

Step 5: Align the mounting holes in the sides of the mounting brackets with the predrilled holes in the mounting surface.



NOTE:

To have the best system heat dissipation, please make sure to face the I/O panel downward (**Figure 3-5**) when mounting the system.

Step 6: Insert four retention screws, two in each bracket, to secure the system to the wall.

3.6 External Peripheral Interface Connectors

The following external peripheral devices can be connected to the external peripheral interface connectors.

- Audio devices
- RJ-45 Ethernet cable
- Serial devices
- USB devices
- VGA monitor

To install these devices, connect the corresponding cable connector from the actual device to the corresponding ECN-360A-D2550 external peripheral interface connector making sure the pins are properly aligned.

3.6.1 Audio Connection

The audio jack on the external audio connector enables the ECN-360A-D2550 to be connected to a stereo sound setup. To install the audio devices, follow the steps below.

Step 1: Identify the audio plugs. The plugs on your home theater system or speakers may not match the colors on the rear panel. If audio plugs are plugged into the wrong jacks, sound quality will be very bad.

Step 2: Plug the audio plug into the audio jack. Plug the audio plug into the audio jack. If the plug on your speakers is different, an adapter will need to be used to plug them into the audio jack. The audio jack on the ECN-360A-D2550 is a line-out port which connects to a headphone or a speaker.

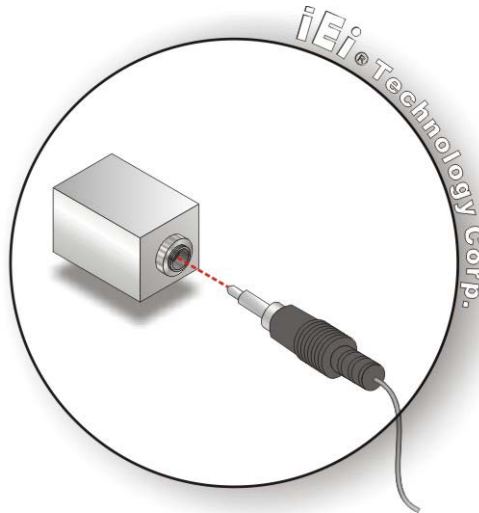

Figure 3-6: Audio Connector

Step 3: Check audio clarity. Check that the sound is coming through the right speakers by adjusting the balance front to rear and left to right.

3.6.2 LAN Connection

There are two external RJ-45 LAN connectors. The RJ-45 connector enables connection to an external network. To connect a LAN cable with an RJ-45 connector, please follow the instructions below.

Step 1: Locate the RJ-45 connectors. The location of the LAN connector is shown in **Chapter 1**.

Step 2: Align the connectors. Align the RJ-45 connector on the LAN cable with one of the RJ-45 connectors on the ECN-360A-D2550. See Figure 3-7.

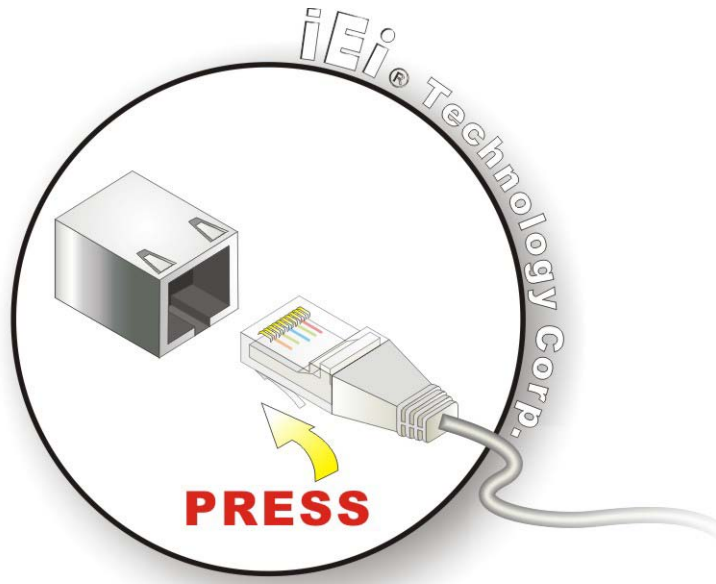

Figure 3-7: LAN Connection

Step 3: Insert the LAN cable RJ-45 connector. Once aligned, gently insert the LAN cable RJ-45 connector into the RJ-45 connector.

3.6.3 DB-9 Serial Port Connection

There are three RS-232 DB-9 connectors and one RS-422/485 DB-9 connector of the ECN-360A-D2550 for serial device connection. Follow the steps below to connect a serial device to the DB-9 connector of the ECN-360A-D2550.

Step 1: Locate the DB-9 connector. The locations of the DB-9 connectors are shown in **Chapter 1**.

Step 2: Insert the serial connector. Insert the DB-9 connector of a serial device into the DB-9 connector on the rear panel. See Figure 3-8.

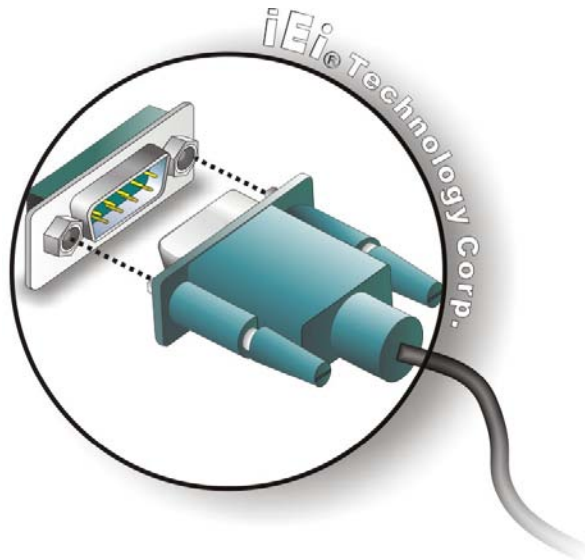

Figure 3-8: DB-9 Serial Port Connector

Step 3: Secure the connector. Secure the serial device connector to the external interface by tightening the two retention screws on either side of the connector.

3.6.4 USB Device Connection



NOTE:

User must install the USB 3.0 driver before connecting a USB device to the system or else the system may not recognize the connected device.

There are six USB 2.0 connectors on the ECN-360A-D2550. To connect a USB device, please follow the instructions below.

Step 1: Locate the USB connectors. The locations of the USB connectors are shown in **Chapter 1**.

Step 2: Align the connectors. Align the USB device connector with one of the connectors on the external peripheral interface. See **Figure 3-10**.

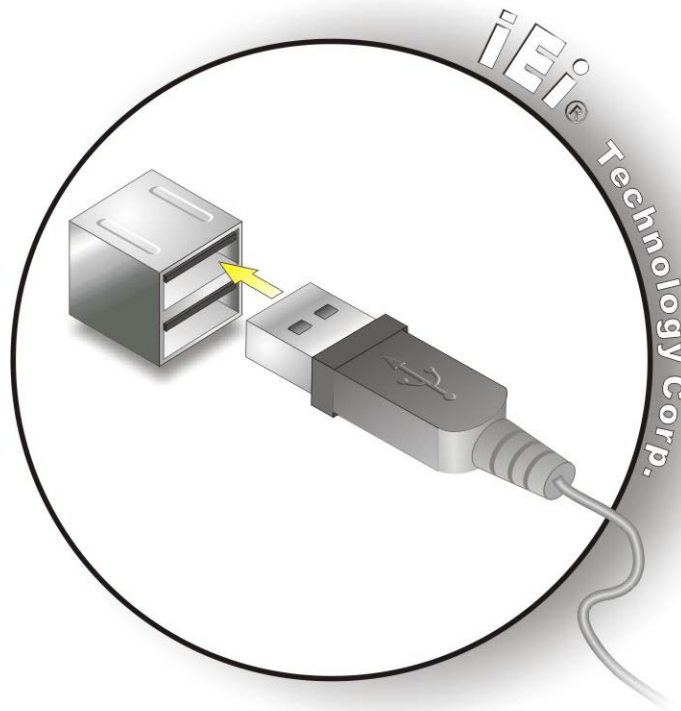

Figure 3-9: USB Device Connection

Step 3: Insert the device connector. Once aligned, gently insert the USB device connector into the onboard connector.

3.6.5 VGA Monitor Connection

The ECN-360A-D2550 has two female DB-15 connectors on the external peripheral interface panel. The DB-15 connector is connected to a CRT or VGA monitor. To connect a monitor to the ECN-360A-D2550, please follow the instructions below.

- Step 1: Locate the female DB-15 connector.** The location of the female DB-15 connector is shown in **Chapter 1**.
- Step 2: Align the VGA connector.** Align the male DB-15 connector on the VGA screen cable with the female DB-15 connector on the external peripheral interface.
- Step 3: Insert the VGA connector.** Once the connectors are properly aligned with the insert the male connector from the VGA screen into the female connector on the ECN-360A-D2550. See **Figure 3-11**.

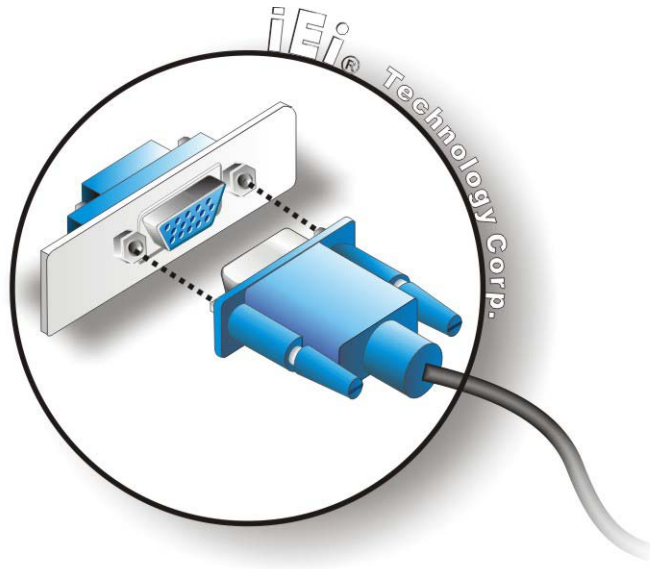

Figure 3-10: VGA Connector

Step 4: Secure the connector. Secure the DB-15 VGA connector from the VGA monitor to the external interface by tightening the two retention screws on either side of the connector.

Chapter

4

System Motherboard

4.1 Peripheral Interface Connectors

This chapter details all the jumpers and connectors.

4.1.1 Layout

The figure below shows all the connectors and jumpers.

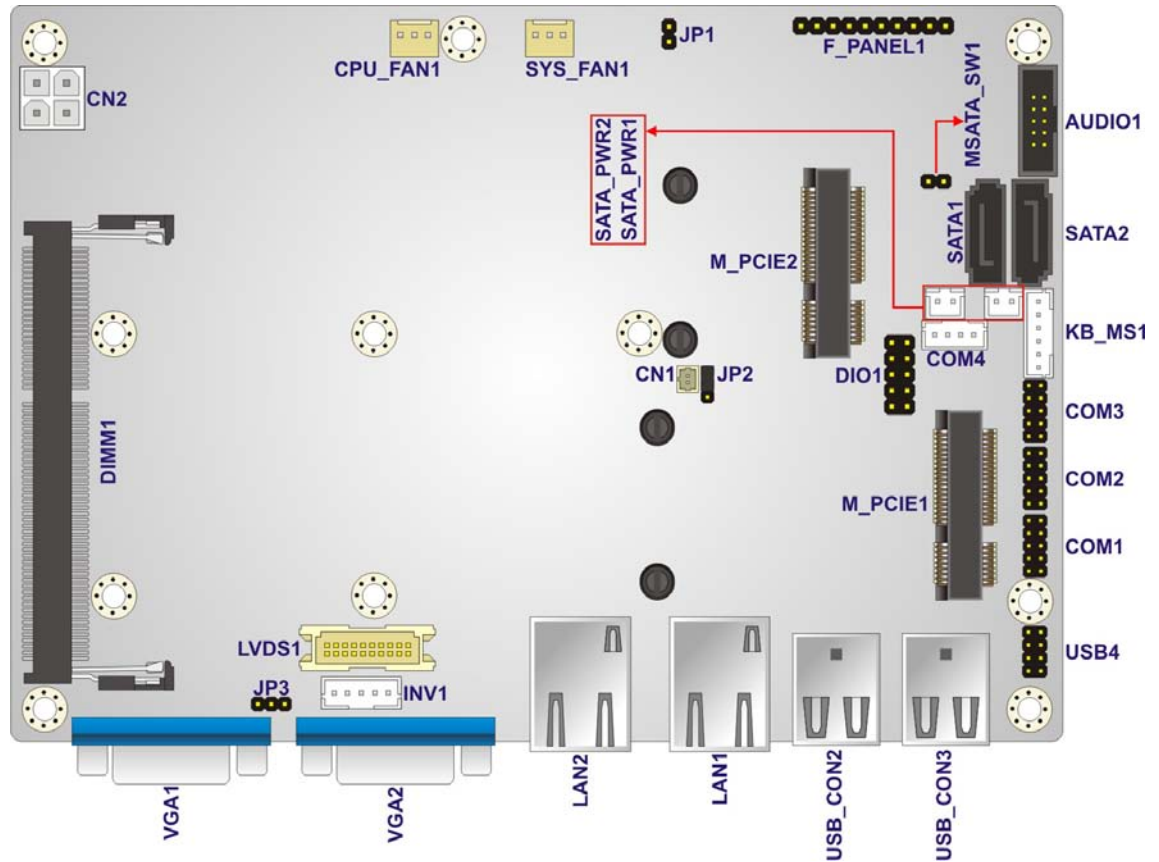

Figure 4-1: Connectors and Jumpers

4.1.2 Peripheral Interface Connectors

The table below lists all the connectors on the board.

Connector	Type	Label
5 V SATA power connectors	2-pin wafer	SATA_PWR1, SATA_PWR2
Audio connector	10-pin box header	AUDIO1

Connector	Type	Label
Backlight inverter connector	5-pin wafer	INV1
Battery connector	2-pin wafer	CN1
Digital Input/Output (DIO) connector	10-pin header	DIO1
Fan connectors	3-pin wafer	CPU_FAN1, SYS_FAN2
Front panel connector	10-pin header	F_PANEL1
Keyboard and mouse connector	6-pin wafer	KB_MS1
LVDS connector	20-pin crimp	LVDS1
PCIe Mini card slots	52-pin PCIe Mini	M_PCIE1, M_PCIE2
Power connector (9V~28V)	4-pin connector	CN2
RS-232 serial port connectors	10-pin header	COM1, COM2, COM3
RS-422/485 serial port connector	4-pin wafer	COM4
Serial ATA (SATA) drive connectors	7-pin SATA	SATA1, SATA2
SO-DIMM connector	SO-DIMM connector	DIMM1
USB 2.0 connector	8-pin header	USB4

Table 4-1: Peripheral Interface Connectors

4.1.3 External Interface Panel Connectors

The table below lists the connectors on the external I/O panel.

Connector	Type	Label
Ethernet connectors	RJ-45	LAN1, LAN2
USB connectors	USB 2.0	USB_CON2, USB_CON3
VGA connectors	15-pin female	VGA1, VGA2

Table 4-2: Rear Panel Connectors

4.2 Internal Peripheral Connectors

The section describes all of the connectors on the motherboard.

4.2.1 5 V SATA Power Connectors

CN Label: SATA_PWR1, SATA_PWR2

CN Type: 2-pin wafer

CN Location: See **Figure 4-2**

CN Pinouts: See **Table 4-3**

Use the 5 V SATA power connectors to connect to SATA device power connection.

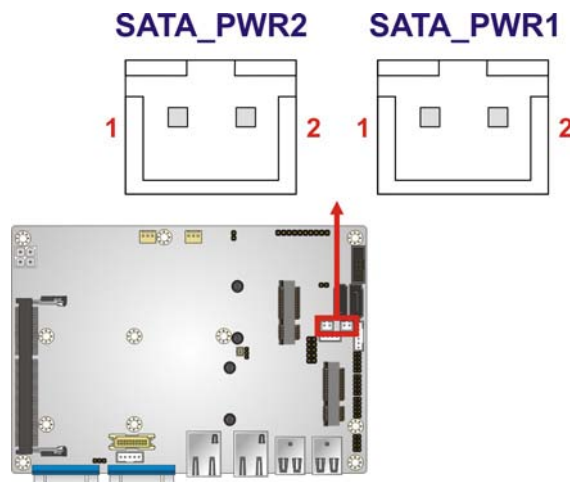

Figure 4-2: 5 V SATA Power Connector Locations

Pin No.	Description
1	+5V
2	Ground

Table 4-3: 5 V SATA Power Connector Pinouts

4.2.2 Audio Connector

CN Label: **AUDIO1**

CN Type: 10-pin box header

CN Location: See **Figure 4-3**

CN Pinouts: See **Table 4-4**

The 10-pin audio connector is connected to external audio devices including speakers and microphones for the input and output of audio signals to and from the system.

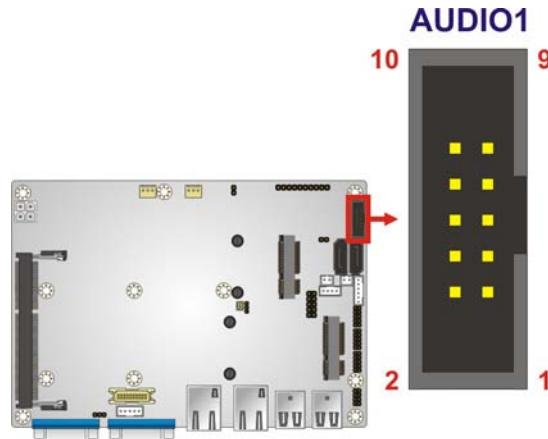

Figure 4-3: Audio Connector Location

Pin	Description	Pin	Description
1	SPK_R	2	LINE1_R
3	AUD_GND	4	AUD_GND
5	SPK_L	6	LINE1_L
7	AUD_GND	8	AUD_GND
9	MIC1_R	10	MIC1_L

Table 4-4: Audio Connector Pinouts

4.2.3 Backlight Inverter Connector

- CN Label: **INV1**
- CN Type: 5-pin wafer
- CN Location: See **Figure 4-4**
- CN Pinouts: See **Table 4-5**

The backlight inverter connector provides the backlight on the LCD display connected to the motherboard with +12V of power.

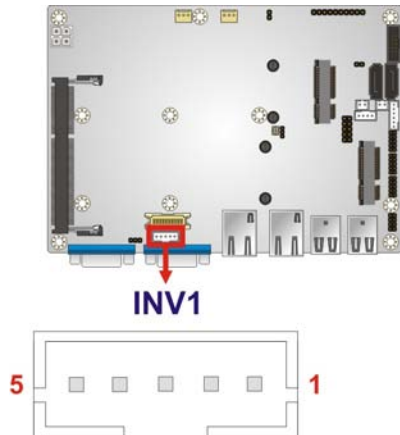
Figure 4-4: Backlight Inverter Connector Location

Pin	Description
1	LCD_BKLTCTL
2	GROUND
3	+12V
4	GROUND
5	BACKLIGHT ENABLE

Table 4-5: Backlight Inverter Connector Pinouts

4.2.4 Battery Connector

CN Label:	CN1
CN Type:	2-pin wafer
CN Location:	See Figure 4-5
CN Pinouts:	See Table 4-6

This is connected to the system battery. The battery provides power to the system clock to retain the time when power is turned off.

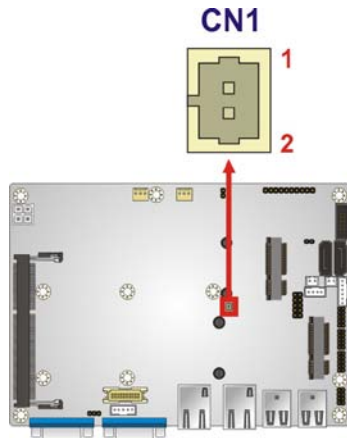

Figure 4-5: Battery Connector Location

Pin	Description
1	Battery+
2	GND

Table 4-6: Battery Connector Pinouts

4.2.5 Digital Input/Output (DIO) Connector

- CN Label: DIO1
- CN Type: 10-pin header
- CN Location: See **Figure 4-6**
- CN Pinouts: See **Table 4-7**

The digital input/output connector is managed through a Super I/O chip. The DIO connector pins are user programmable.

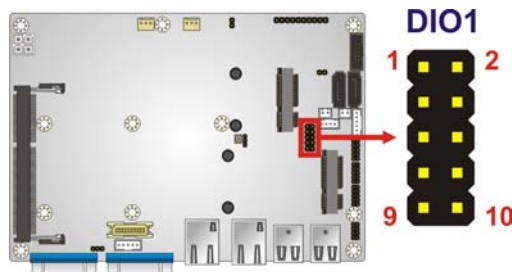

Figure 4-6: Digital I/O Connector Location

Pin	Description	Pin	Description
1	GND	2	VCC

Pin	Description	Pin	Description
3	Output 3	4	Output 2
5	Output 1	6	Output 0
7	Input 3	8	Input 2
9	Input 1	10	Input 0

Table 4-7: Digital I/O Connector Pinouts

4.2.6 Fan Connectors

CN Label: CPU_FAN1, SYS_FAN1

CN Type: 3-pin wafer

CN Location: See **Figure 4-7**

CN Pinouts: See **Table 4-8**

The fan connectors attach to the CPU/system cooling fans.

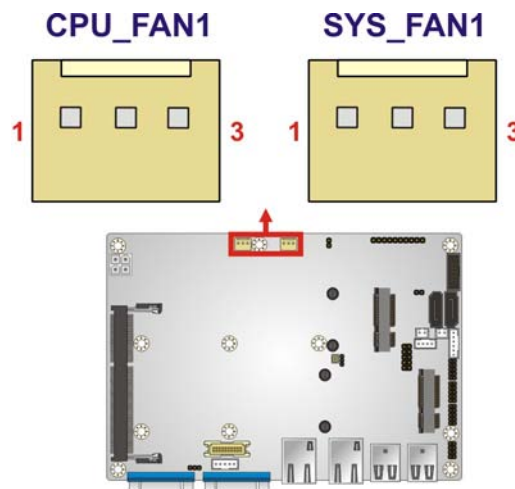
Figure 4-7: Fan Connector Locations

PIN NO.	DESCRIPTION
1	FANIO
2	+12V (PWM)
3	Ground

Table 4-8: Fan Connector Pinouts

4.2.7 Front Panel Connector

- CN Label: F_PANEL1
- CN Type: 10-pin header
- CN Location: See **Figure 4-8**
- CN Pinouts: See **Table 4-9**

The front panel connector connects to the indicator LEDs and buttons on the computer's front panel.

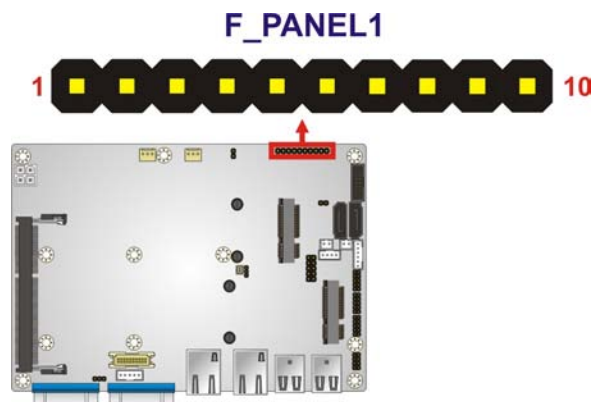

Figure 4-8: Front Panel Connector Location

Function	Pin	Description	Function	Pin	Description
Power Button	1	NC	Power LED	6	PWRLED
	2	PWRBTSW#		7	PWRLED
	3	GND		8	GND
HDD LED	4	+V5S	Reset Button	9	RESET+
	5	HDD_LED-		10	GND

Table 4-9: Front Panel Connector Pinouts

4.2.8 Keyboard/Mouse Connector

- CN Label: KB_MS1
- CN Type: 6-pin wafer
- CN Location: See **Figure 4-9**
- CN Pinouts: See **Table 4-10**

The keyboard and mouse connector can be connected to a standard PS/2 cable or PS/2 Y-cable to add keyboard and mouse functionality to the system.

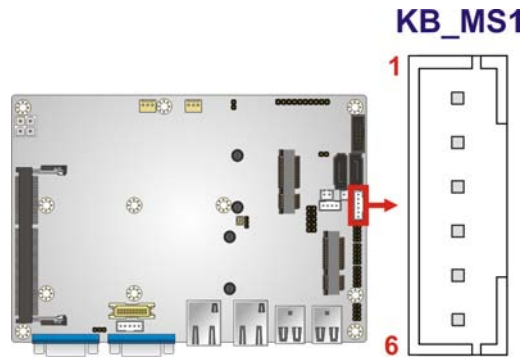

Figure 4-9: Keyboard/Mouse Connector Location

Pin	Description
1	VCC
2	Mouse Data
3	Mouse Clock
4	Keyboard Data
5	Keyboard Clock
6	GND

Table 4-10: Keyboard/Mouse Connector Pinouts

4.2.9 LVDS 1 Connector

CN Label:	LVDS 1
CN Type:	20-pin crimp
CN Location:	See Figure 4-10
CN Pinouts:	See Table 4-11

The 20-pin LVDS LCD connector can be connected to an 18-bit/24-bit single-channel LVDS panel.

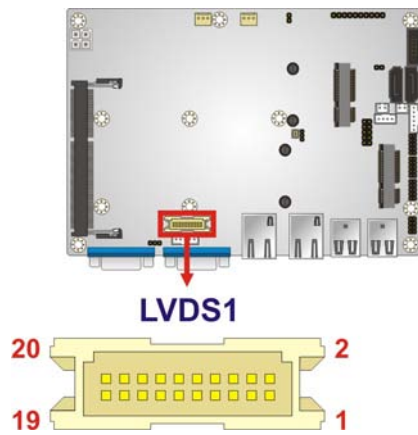

Figure 4-10: LVDS1 Connector Location

Pin	Description	Pin	Description
1	GND	2	GND
3	LVDS_DATA0	4	LVDS_DATA0#
5	LVDS_DATA1	6	LVDS_DATA1#
7	LVDS_DATA2	8	LVDS_DATA2#
9	LVDS_CLK	10	LVDS_CLK#
11	NC	12	NC
13	GND	14	GND
15	LDDC_DATA	16	LDDC_CLK
17	VCC_LCD	18	VCC_LCD
19	VCC_LCD	20	VCC_LCD

Table 4-11: LVDS1 Connector Pinouts

4.2.10 PCIe Mini Card Slots

- CN Label: M_PCIE1, M_PCIE2
- CN Type: 52-pin PCIe Mini card slot
- CN Location: See **Figure 4-11**
- CN Pinouts: See **Table 4-12**

The **M_PCIE1** slot can be connected to a full-size PCIe Mini card while the **M_PCIE2** slot can be connected to a half-size PCIe Mini card.

NOTE:

The **M_PCIE1** slot supports mSATA devices. However, the **SATA1** connector will be disabled when an mSATA device is installed to the **M_PCIE1** slot.

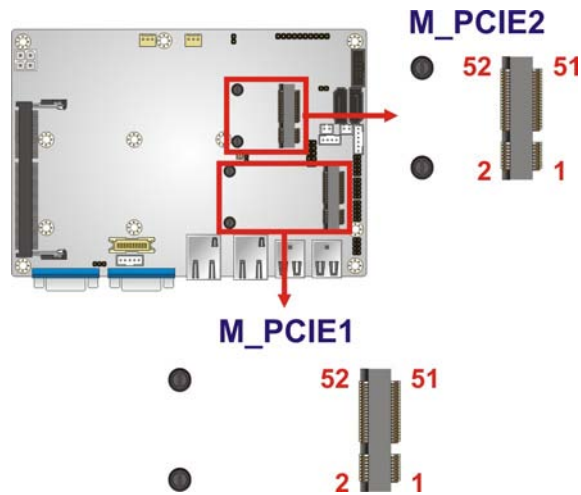
Figure 4-11: PCIe Mini Card Slot Locations

Pin	Description	Pin	Description
1	PCIE_WAKE#	2	VCC3
3	N/C	4	GND
5	N/C	6	1.5V
7	N/C	8	N/C
9	GND	10	N/C
11	PCIE_CLK#	12	N/C
13	PCIE_CLK	14	N/C
15	GND	16	N/C
17	N/C	18	GND
19	N/C	20	N/C
21	GND	22	PCIRST#
23	PCIE_RXN	24	VCC3
25	PCIE_RXP	26	GND
27	GND	28	1.5V

Pin	Description	Pin	Description
29	GND	30	SMBCLK
31	PCIE_TXN	32	SMBDATA
33	PCIE_TXP	34	GND
35	GND	36	USB D-
37	GND	38	USB D+
39	VCC3	40	GND
41	VCC3	42	N/C
43	GND	44	N/C
45	N/C	46	N/C
47	N/C	48	1.5V
49	N/C	50	GND
51	M-SATA Detect	52	VCC3

Table 4-12: PCIe Mini Card Slot Pinouts

4.2.11 Power Connector (9V~28V)

- CN Label: CN2
- CN Type: 4-pin connector
- CN Location: See **Figure 4-12**
- CN Pinouts: See **Table 4-13**

The power connector is connected to an external power supply and supports 9V~28V power input. Power is provided to the system, from the power supply through this connector.

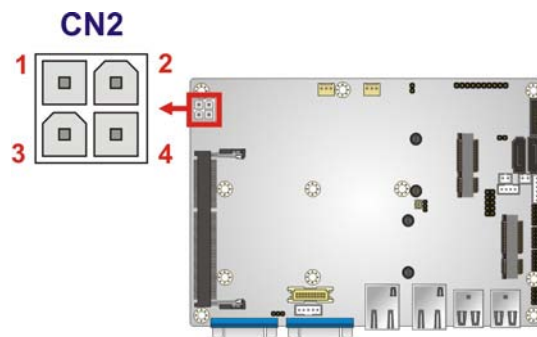

Figure 4-12: Power Connector Location

Pin	Description	Pin	Description
1	GND	2	GND
3	PWR	4	PWR

Table 4-13: Power Connector Pinouts

4.2.12 RS-232 Serial Port Connectors

CN Label: COM1, COM2, COM3

CN Type: 10-pin header

CN Location: See **Figure 4-13**

CN Pinouts: See **Table 4-14**

Each of these connectors provides RS-232 connections.

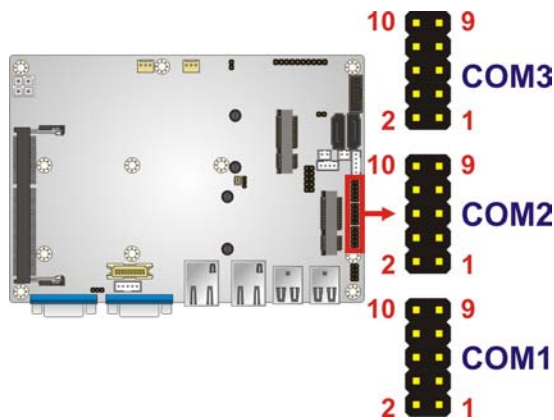
Figure 4-13: RS-232 Serial Port Connector Locations

Pin	Description	Pin	Description
1	DCD	2	DSR
3	RXD	4	RTS
5	TXD	6	CTS
7	DTR	8	RI
9	GND	10	GND

Table 4-14: RS-232 Serial Port Connector Pinouts

4.2.13 RS-422/485 Serial Port Connector

- CN Label: COM4
- CN Type: 4-pin wafer
- CN Location: See **Figure 4-14**
- CN Pinouts: See **Table 4-15**

This connector provides RS-422 or RS-485 communications.

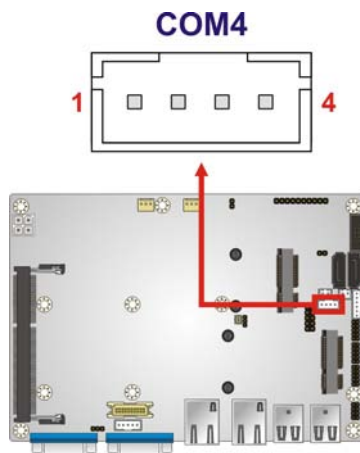

Figure 4-14: RS-422/485 Connector Location

Pin	Description	Pin	Description
1	RXD422-	3	TXD422+/TXD485+
2	RXD422+	4	TXD422-/TXD485-

Table 4-15: RS-422/485 Connector Pinouts

4.2.14 SATA Drive Connectors

- CN Label: SATA1, SATA2
- CN Type: 7-pin SATA drive connector
- CN Location: See **Figure 4-15**
- CN Pinouts: See **Table 4-16**

The SATA drive connectors can be connected to SATA drives and support up to 3Gb/s data transfer rate.



NOTE:

The **SATA1** connector will be disabled when an mSATA device is installed to the **M_PCIE1** slot.

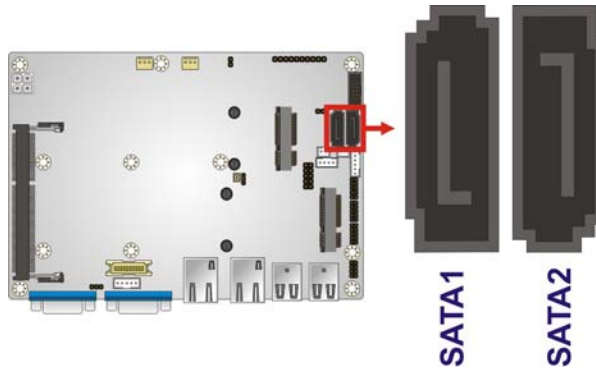

Figure 4-15: SATA Drive Connector Locations

Pin	Description
1	GND
2	TX+
3	TX-
4	GND
5	RX-
6	RX+
7	GND

Table 4-16: SATA Drive Connector Pinouts

4.2.15 SO-DIMM Connector

- CN Label: DIMM1
- CN Type: 204-pin DDR3 SO-DIMM connector
- CN Location: See **Figure 4-16**

The SO-DIMM connector is for installing memory on the system.

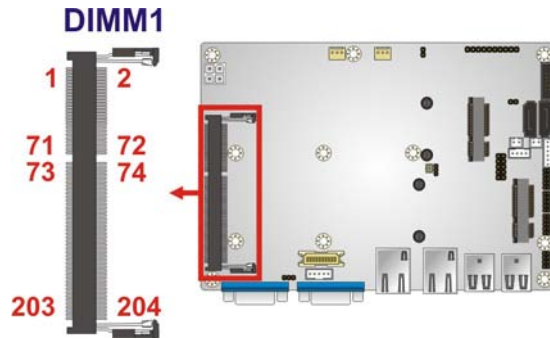

Figure 4-16: SO-DIMM Connector Location

4.2.16 USB Connector

- CN Label: USB4
- CN Type: 8-pin header
- CN Location: See **Figure 4-17**
- CN Pinouts: See **Table 4-17**

The USB connector provides connectivity to two USB 1.1/2.0 ports.

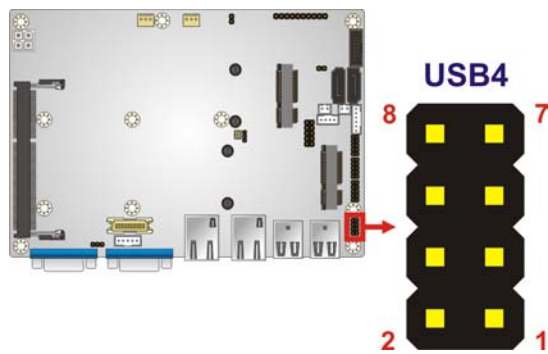

Figure 4-17: USB Connector Location

Pin	Description	Pin	Description
1	USB_VCC	2	GND
3	DATA-	4	DATA+
5	DATA+	6	DATA-
7	GND	8	USB_VCC

Table 4-17: USB Connector Pinouts

4.3 External Peripheral Interface Connector Panel

The figure below shows the external peripheral interface connector (EPIC) panel. The EPIC panel consists of the following:

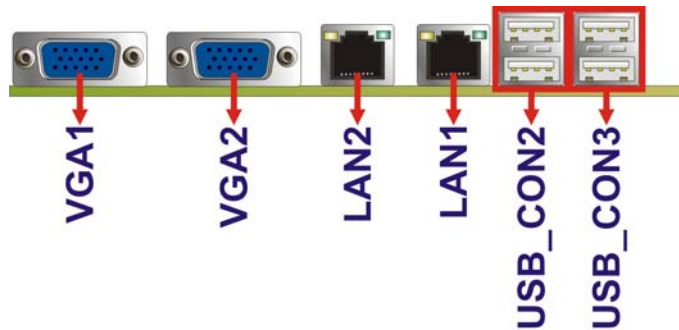

Figure 4-18: External Peripheral Interface Connector

4.3.1 Ethernet Connectors

CN Label:	LAN1, LAN2
CN Type:	RJ-45 connector
CN Location:	See Figure 4-18
CN Pinouts:	See Table 4-18

The motherboard is equipped with two built-in RJ-45 Ethernet controllers. Each controller can connect to the LAN through one RJ-45 LAN connector.

Pin	Description	Pin	Description
1	MD10+	5	MD12+
2	MD10-	6	MD12-
3	MD11+	7	MD13+
4	MD11-	8	MD13-

Table 4-18: LAN Pinouts

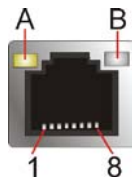

Figure 4-19: RJ-45 Ethernet Connector

LED	Description	LED	Description
A	on: linked blinking: data is being sent/received	B	off: 10 Mb/s green: 100 Mb/s orange: 1000 Mb/s

Table 4-19: RJ-45 Ethernet Connector LEDs

4.3.2 USB Connectors

CN Label: USB_CON2, USB_CON3

CN Type: Dual USB 2.0 port

CN Location: See **Figure 4-18**

CN Pinouts: See **Table 4-20**

The ports connect to both USB 2.0 and USB 1.1 devices.

Pin	Description	Pin	Description
1	USB_VCC	2	USB_VCC
3	DATA-	4	DATA-
5	DATA+	6	DATA+
7	GND	8	GND

Table 4-20: USB Port Pinouts

4.3.3 VGA Connectors

- CN Label: VGA1, VGA2
 CN Type: 15-pin Female
 CN Location: See **Figure 4-18**
 CN Pinouts: See **Table 4-21** and **Figure 4-20**

Each VGA connector connects to a monitor that accepts a standard VGA input.

Pin	Description	Pin	Description
1	RED	2	GREEN
3	BLUE	4	NC
5	GND	6	GND
7	GND	8	GND
9	VCC	10	GND
11	NC	12	DDCDAT
13	HSYNC	14	VSYNC
15	DDCCLK		

Table 4-21: VGA Connector Pinouts

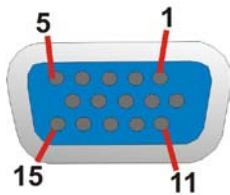

Figure 4-20: VGA Connector

4.4 Jumper Settings



NOTE:

A jumper is a metal bridge used to close an electrical circuit. It consists of two or three metal pins and a small metal clip (often protected by a plastic cover) that slides over the pins to connect them. To CLOSE/SHORT a jumper means connecting the pins of the jumper with the plastic clip and to OPEN a jumper means removing the plastic clip from a jumper.

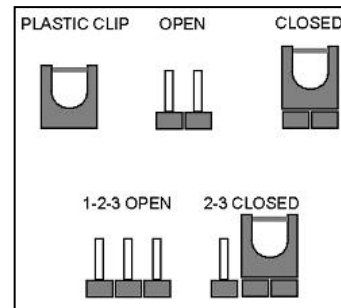

The jumpers on the motherboard are listed in **Table 4-22**.

Description	Label	Type
AT/ATX power selection	JP1	2-pin header
Clear CMOS	JP2	3-pin header
LVDS1 voltage selection	JP3	3-pin header
mSATA/PCIe Mini selection	MSATA_SW1	2-pin header

Table 4-22: Jumpers

4.4.1 AT/ATX Power Selection Jumper

Jumper Label:	JP1
Jumper Type:	2-pin header
Jumper Settings:	See Table 4-23
Jumper Location:	See Figure 4-21

The AT/ATX power selection jumper specifies the system power mode as AT or ATX.

Setting	Description
Short 1-2	Use ATX power (Default)

Setting	Description
Off	Use AT power

Table 4-23: AT/ATX Power Selection Jumper Settings

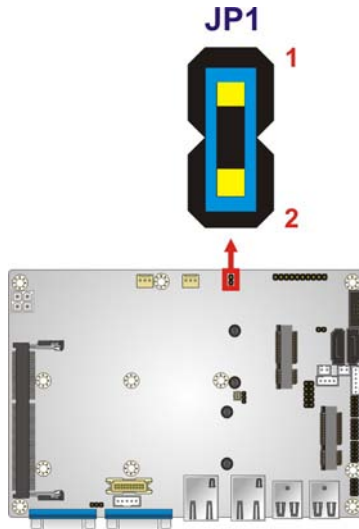

Figure 4-21: AT/ATX Power Selection Jumper Location

4.4.2 Clear CMOS Jumper

Jumper Label:	JP2
Jumper Type:	3-pin header
Jumper Settings:	See Table 4-24
Jumper Location:	See Figure 4-22

To reset the BIOS, move the jumper to the "Clear BIOS" position for 3 seconds or more, and then move back to the default position.

Setting	Description
Short 1-2	Normal (Default)
Short 2-3	Clear BIOS

Table 4-24: Clear CMOS Jumper Settings

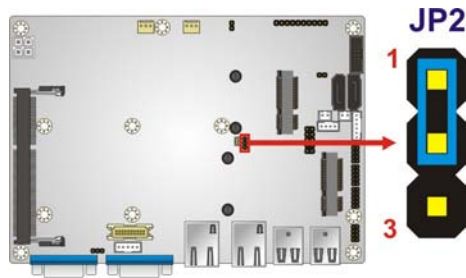

Figure 4-22: Clear CMOS Jumper Location

4.4.3 LVDS 1 Voltage Selection



WARNING:

Permanent damage to the screen and ECN-360A-D2550 may occur if the wrong voltage is selected with this jumper. Please refer to the user guide that came with the monitor to select the correct voltage.

Jumper Label:	JP3
Jumper Type:	3-pin header
Jumper Settings:	See Table 4-25
Jumper Location:	See Figure 4-23

Sets the voltage provided to the monitor by LVDS1.

Setting	Description
Short 1-2	+3.3V LVDS (Default)
Short 2-3	+5V LVDS

Table 4-25: LVDS1 Voltage Selection Jumper Settings

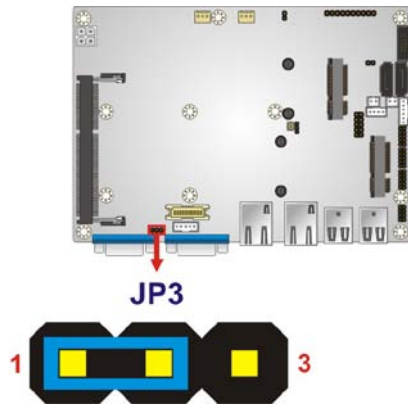

Figure 4-23: LVDS1 Voltage Selection Jumper Location

4.4.4 mSATA/PCIe Mini Selection

- Jumper Label: **MSATA_SW1**
- Jumper Type: 2-pin header
- Jumper Settings: See **Table 4-26**
- Jumper Location: See **Figure 4-24**

The mSATA/PCIe Mini mode selection jumper specifies the M_PCIE1 connector as MSATA or PCIe Mini mode.

Setting	Description
Off	Auto detection (Default)
Short 1-2	PCIe Mini

Table 4-26: mSATA/PCIe Mini Mode Selection Jumper Settings

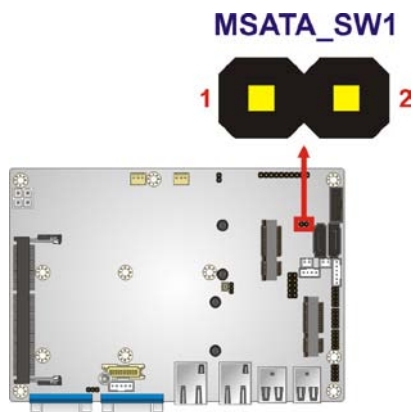

Figure 4-24: mSATA/PCIe Mini Mode Selection Jumper Location

Chapter

5

BIOS

5.1 Introduction

The BIOS is programmed onto the BIOS chip. The BIOS setup program allows changes to certain system settings. This chapter outlines the options that can be changed.

5.1.1 Starting Setup

The UEFI BIOS is activated when the computer is turned on. The setup program can be activated in one of two ways.

1. Press the **DEL** or **F2** key as soon as the system is turned on or
2. Press the **DEL** or **F2** key when the “**Press DEL or F2 to enter SETUP**” message appears on the screen.

If the message disappears before the **DEL** or **F2** key is pressed, restart the computer and try again.

5.1.2 Using Setup

Use the arrow keys to highlight items, press **ENTER** to select, use the PageUp and PageDown keys to change entries, press **F1** for help and press **ESC** to quit. Navigation keys are shown in.

Key	Function
Up arrow	Move to previous item
Down arrow	Move to next item
Left arrow	Move to the item on the left hand side
Right arrow	Move to the item on the right hand side
+	Increase the numeric value or make changes
-	Decrease the numeric value or make changes
Page Up key	Move to the next page
Page Dn key	Move to the previous page

Key	Function
Esc key	Main Menu – Quit and not save changes into CMOS Status Page Setup Menu and Option Page Setup Menu -- Exit current page and return to Main Menu
F1	General help, only for Status Page Setup Menu and Option Page Setup Menu
F2	Load previous values
F3	Load optimized defaults
F4	Save changes and Exit BIOS

Table 5-1: BIOS Navigation Keys

5.1.3 Getting Help

When **F1** is pressed a small help window describing the appropriate keys to use and the possible selections for the highlighted item appears. To exit the Help Window press **Esc** or the **F1** key again.

5.1.4 Unable to Reboot after Configuration Changes

If the computer cannot boot after changes to the system configuration is made, CMOS defaults. Use the jumper described in Chapter 4.

5.1.5 BIOS Menu Bar

The **menu bar** on top of the BIOS screen has the following main items:

- Main – Changes the basic system configuration.
- Advanced – Changes the advanced system settings.
- Chipset – Changes the chipset settings.
- Boot – Changes the system boot configuration.
- Security – Sets User and Supervisor Passwords.
- Save & Exit – Selects exit options and loads default settings.

The following sections completely describe the configuration options found in the menu items at the top of the BIOS screen and listed above.

5.2 Main

The **Main** BIOS menu (**BIOS Menu 1**) appears when the **BIOS Setup** program is entered. The **Main** menu gives an overview of the basic system information.

```

Aptio Setup Utility - Copyright (C) 2011 American Megatrends, Inc.
Main  Advanced  Chipset  Boot  Security  Save & Exit

BIOS Information
BIOS Vendor                American Megatrends
Core Version               4.6.5.3 0.16
Compliancy                 UEFI 2.3; PI 1.2
Project Version            B239AR10.ROM
Build Date and Time        05/11/2012 11:53:40

System Date                 [Mon 07/16/2012]
System Time                 [15:10:27]

Access Level                Administrator

Set the Date. Use Tab to
switch between Data
elements.

-----

-><: Select Screen
↑ ↓: Select Item
Enter: Select
+/-: Change Opt.
F1: General Help
F2: Previous Values
F3: Optimized Defaults
F4: Save & Exit
ESC: Exit

Version 2.14.1219. Copyright (C) 2011 American Megatrends, Inc.
    
```

BIOS Menu 1: Main

→ System Overview

The **BIOS Information** lists a brief summary of the BIOS. The fields in **BIOS Information** cannot be changed. The items shown in the system overview include:

- **BIOS Vendor:** Installed BIOS vendor
- **Core Version:** Current BIOS version
- **Project Version:** the board version
- **Build Date and Time:** Date and time the current BIOS version was made

The System Overview field also has two user configurable fields:

→ System Date [xx/xx/xx]

Use the **System Date** option to set the system date. Manually enter the day, month and year.

ECN-360A-D2550 Embedded System

→ System Time [xx:xx:xx]

Use the **System Time** option to set the system time. Manually enter the hours, minutes and seconds.

5.3 Advanced

Use the **Advanced** menu (**BIOS Menu 2**) to configure the CPU and peripheral devices through the following sub-menus:



WARNING:

Setting the wrong values in the sections below may cause the system to malfunction. Make sure that the settings made are compatible with the hardware.

```

Aptio Setup Utility - Copyright (C) 2011 American Megatrends, Inc.
Main  Advanced  Chipset  Boot  Security  Save & Exit

> ACPI Settings
> RTC Wake Settings
> CPU Configuration
> IDE Configuration
> USB Configuration
> F81866 Super IO Configuration
> F81866 H/W Monitor
> Serial Port Console Redirection
> iEi Feature

System ACPI Parameters
-----
→←: Select Screen
↑↓: Select Item
Enter: Select
+/-: Change Opt.
F1: General Help
F2: Previous Values
F3: Optimized Defaults
F4: Save & Exit
ESC: Exit

Version 2.14.1219. Copyright (C) 2011 American Megatrends, Inc.
  
```

BIOS Menu 2: Advanced

5.3.1 ACPI Settings

The **ACPI Settings** menu (**BIOS Menu 3**) configures the Advanced Configuration and Power Interface (ACPI) options.

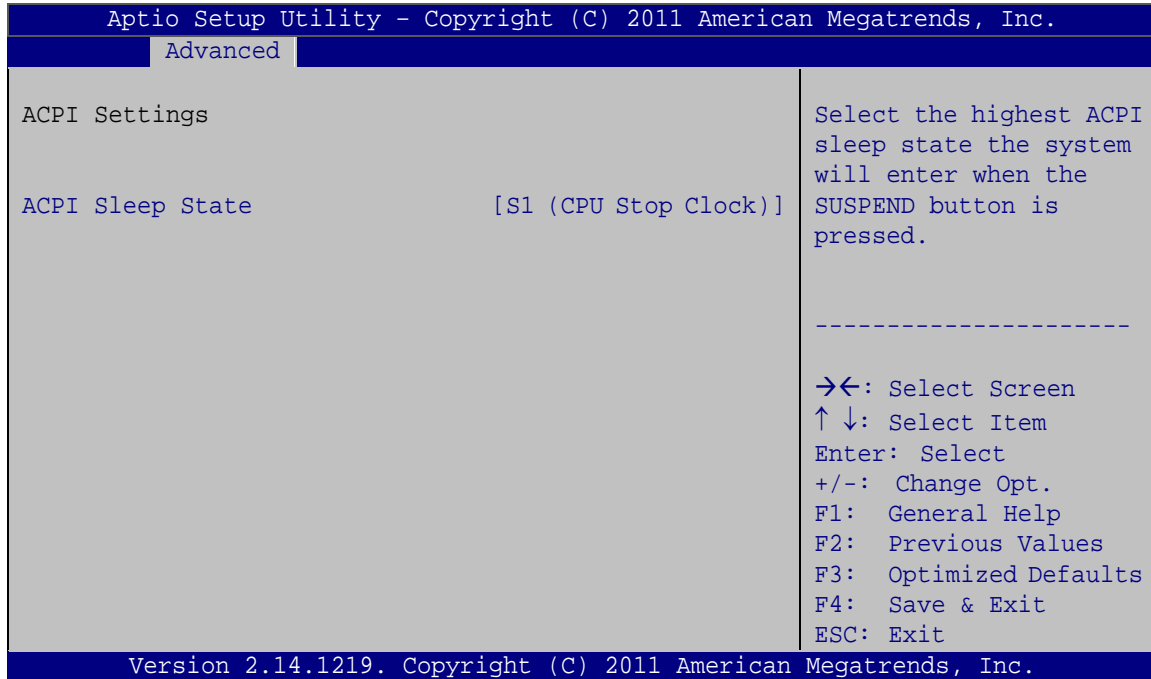

BIOS Menu 3: ACPI Settings

→ ACPI Sleep State [S1 (CPU Stop Clock)]

Use the **ACPI Sleep State** option to specify the sleep state the system enters when it is not being used.

- **S1 (CPU Stop DEFAULT Clock)** The system enters S1 (POS) sleep state. The system appears off. The CPU is stopped; RAM is refreshed; the system is running in a low power mode.
- **S3 (Suspend to RAM)** The caches are flushed and the CPU is powered off. Power to the RAM is maintained. The computer returns slower to a working state, but more power is saved.

5.3.2 RTC Wake Settings

The **RTC Wake Settings** menu (**BIOS Menu 4**) enables the system to wake at the specified time.

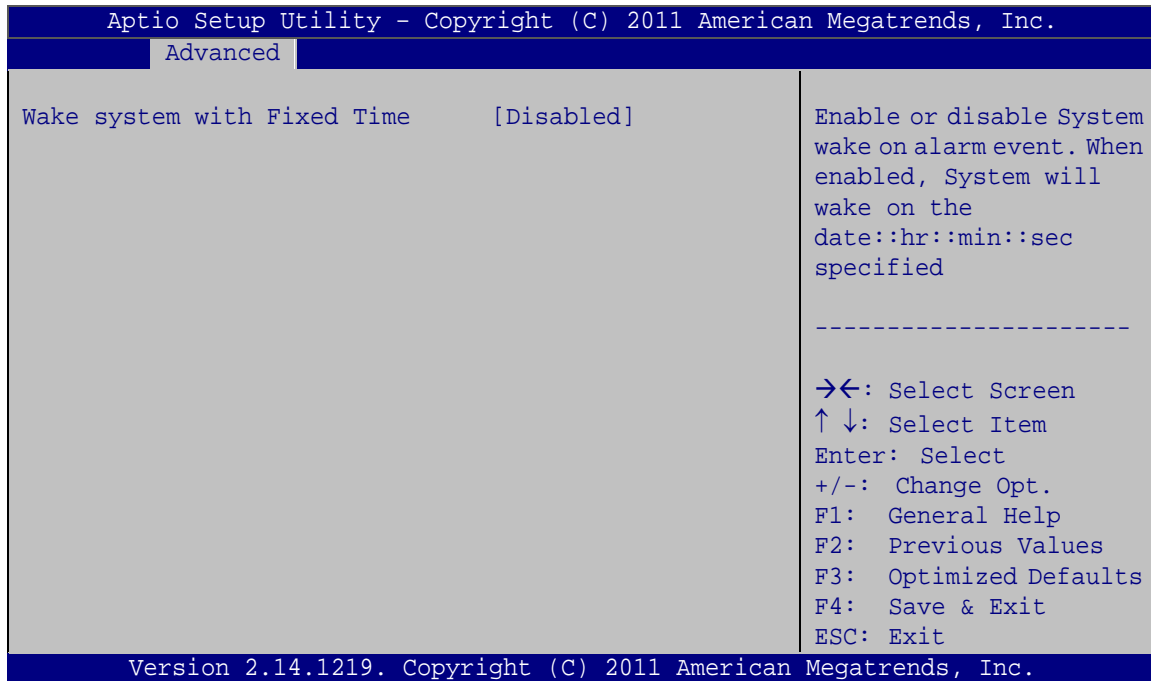

BIOS Menu 4: RTC Wake Settings

→ Wake system with Fixed Time [Disabled]

Use the **Wake system with Fixed Time** option to enable or disable the system wake on alarm event.

→ **Disabled** **DEFAULT** The real time clock (RTC) cannot generate a wake event

→ **Enabled** If selected, the **Wake up every day** option appears allowing you to enable to disable the system to wake every day at the specified time. Besides, the following options appear with values that can be selected:

Wake up date

Wake up hour

Wake up minute

Wake up second

After setting the alarm, the computer turns itself on from a suspend state when the alarm goes off.

5.3.3 CPU Configuration

Use the **CPU Configuration** menu (**BIOS Menu 5**) to view detailed CPU specifications and configure the CPU.

```

Aptio Setup Utility - Copyright (C) 2011 American Megatrends, Inc.
  Advanced
CPU Configuration
Processor Type           Intel(R) Atom(TM)
                        CPU D2550 @ 1.86GHz
EMT64                   Supported
Processor Speed         1865 MHz
System Bus Speed        533 MHz
Ratio Status            14
Actual Ratio            14
System Bus Speed        533 MHz
Processor Stepping      30661
Microcode Revision      269
L1 Cache RAM            2x56 k
L2 Cache RAM            2x512 k
Processor Core           Dual
Hyper-Threading         Supported

Hyper-Threading         [Enabled]

Enabled for Windows XP
and Linux (OS optimized
for Hyper-Threading
Technology) and Disabled
for other OS (OS not
optimized for
Hyper-Threading
Technology).

-----
-><: Select Screen
↑↓: Select Item
Enter: Select
+/-: Change Opt.
F1: General Help
F2: Previous Values
F3: Optimized Defaults
F4: Save & Exit
ESC: Exit

Version 2.14.1219. Copyright (C) 2011 American Megatrends, Inc.
    
```

BIOS Menu 5: CPU Configuration

The CPU Configuration menu (**BIOS Menu 5**) lists the following CPU details:

- **Processor Type:** Lists the brand name of the CPU being used.
- **EMT64:** Indicates if EMT64 is supported by the CPU.
- **Processor Speed:** Lists the CPU processing speed.
- **System Bus Speed:** Lists the system bus speed.
- **Ratio Status:** Lists the ratio status.
- **Actual Ratio:** Lists the ratio of the frequency to the clock speed.
- **Processor Stepping:** Lists the CPU ID.
- **Microcode Revision:** Lists the microcode revision.
- **L1 Cache RAM:** Lists the CPU L1 cache size.
- **L2 Cache RAM:** Lists the CPU L2 cache size.
- **Processor Core:** Lists the number of the processor core.
- **Hyper-Threading:** Indicates if Intel HT Technology is supported by the CPU.

ECN-360A-D2550 Embedded System

→ Hyper-Threading [Enabled]

Use the **Hyper-Threading** BIOS option to enable or disable the Intel Hyper-Threading Technology.

- **Disabled** Disables the Intel Hyper-Threading Technology.
- **Enabled** **DEFAULT** Enables the Intel Hyper-Threading Technology.

5.3.4 IDE Configuration

Use the **IDE Configuration** menu (**BIOS Menu 6**) to change and/or set the configuration of the SATA devices installed in the system.

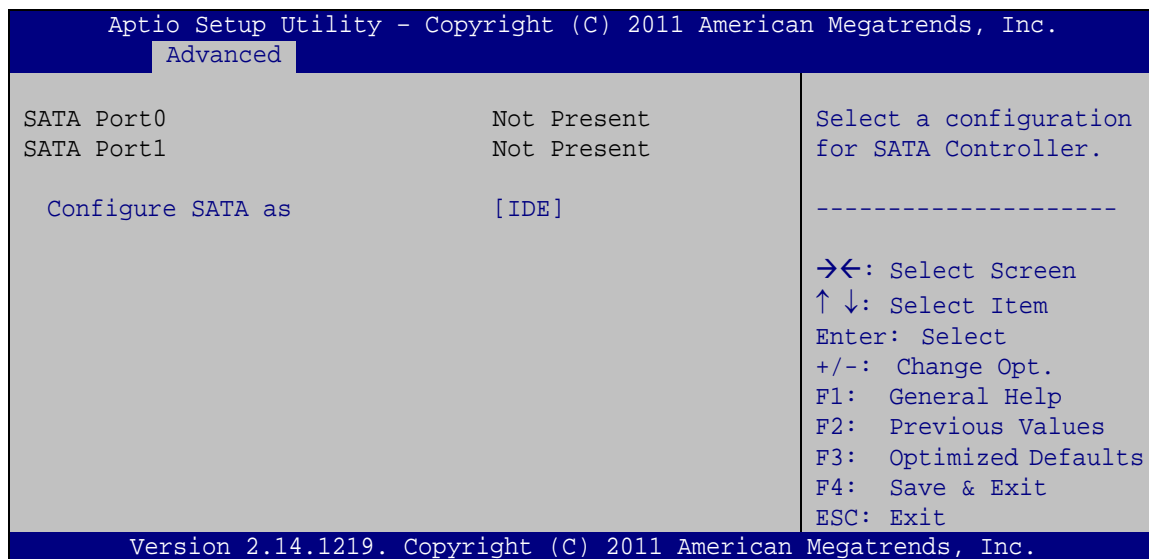

BIOS Menu 6: IDE Configuration

→ Configure SATA as [IDE]

Use the **Configure SATA as** option to configure SATA devices as normal IDE or AHCI devices.

- **IDE** **DEFAULT** Configures SATA devices as normal IDE device.
- **AHCI** Configures SATA devices as AHCI device.

5.3.5 USB Configuration

Use the **USB Configuration** menu (**BIOS Menu 7**) to read USB configuration information and configure the USB settings.

```

Aptio Setup Utility - Copyright (C) 2011 American Megatrends, Inc.
  Advanced
-----
USB Configuration
USB Devices:
  1 Keyboard
Legacy USB Support          [Enabled]
-----
Enables Legacy USB
support. AUTO option
disables legacy support
if no USB devices are
connected. DISABLE
option will keep USB
devices available only
for EFI applications.

-----
-><: Select Screen
↑↓: Select Item
Enter: Select
+/-: Change Opt.
F1: General Help
F2: Previous Values
F3: Optimized Defaults
F4: Save & Exit
ESC: Exit

Version 2.14.1219. Copyright (C) 2011 American Megatrends, Inc.
    
```

BIOS Menu 7: USB Configuration

➔ USB Devices

The **USB Devices** field lists the USB devices that are enabled on the system

➔ Legacy USB Support [Enabled]

Use the **Legacy USB Support** BIOS option to enable USB mouse and USB keyboard support.

Normally if this option is not enabled, any attached USB mouse or USB keyboard does not become available until a USB compatible operating system is fully booted with all USB drivers loaded. When this option is enabled, any attached USB mouse or USB keyboard can control the system even when there is no USB driver loaded onto the system.

➔ **Disabled** Legacy USB support disabled

ECN-360A-D2550 Embedded System

- ➔ **Enabled** **DEFAULT** Legacy USB support enabled
- ➔ **Auto** Legacy USB support disabled if no USB devices are connected

5.3.6 F81866 Super IO Configuration

Use the **F81866 Super IO Configuration** menu (**BIOS Menu 8**) to set or change the configurations for the serial ports.

```

Aptio Setup Utility - Copyright (C) 2011 American Megatrends, Inc.
  Advanced
F81866 Super IO Configuration
F81866 Super IO Chip          F81866
> Serial Port 1 Configuration
> Serial Port 2 Configuration
> Serial Port 3 Configuration
> Serial Port 4 Configuration

Set Parameters of Serial Port 1 (COMA)
-----
-><: Select Screen
↑↓: Select Item
Enter: Select
+/-: Change Opt.
F1: General Help
F2: Previous Values
F3: Optimized Defaults
F4: Save & Exit
ESC: Exit

Version 2.14.1219. Copyright (C) 2011 American Megatrends, Inc.
  
```

BIOS Menu 8: Super IO Configuration

5.3.6.1 Serial Port n Configuration

Use the **Serial Port n Configuration** menu (**BIOS Menu 9**) to configure the serial port n.

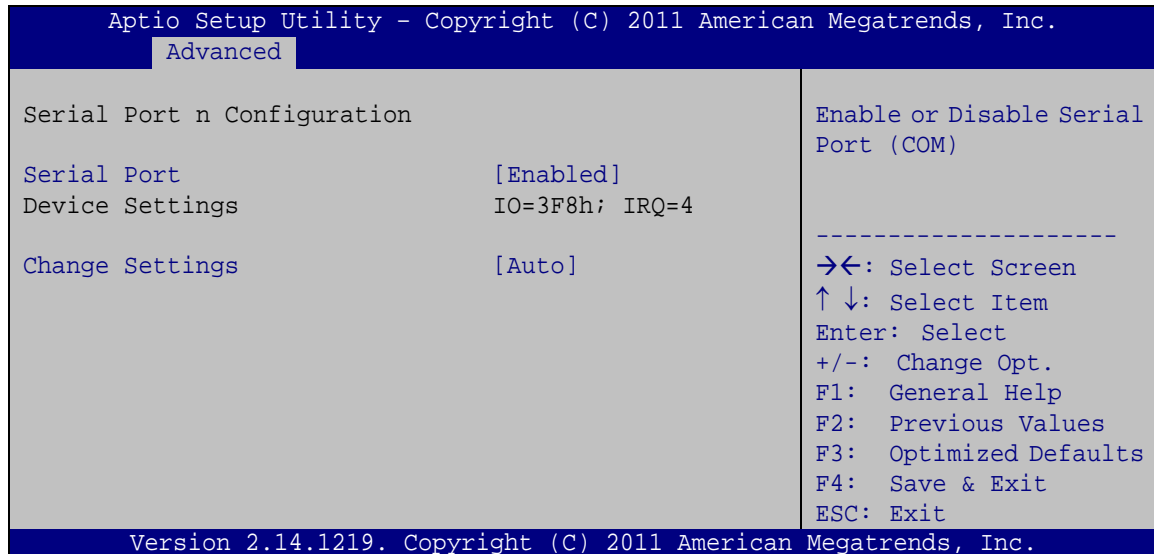

BIOS Menu 9: Serial Port n Configuration Menu

5.3.6.1.1 Serial Port 1 Configuration

→ Serial Port [Enabled]

Use the **Serial Port** option to enable or disable the serial port.

- **Disabled** Disable the serial port
- **Enabled** **DEFAULT** Enable the serial port

→ Change Settings [Auto]

Use the **Change Settings** option to change the serial port IO port address and interrupt address.

- **Auto** **DEFAULT** The serial port IO port address and interrupt address are automatically detected.
- **IO=3F8h;**
IRQ=4 Serial Port I/O port address is 3F8h and the interrupt address is IRQ4
- **IO=3F8h;**
IRQ=3, 4 Serial Port I/O port address is 3F8h and the interrupt address is IRQ3, 4

- ➔ **IO=2F8h;**
IRQ=3, 4 Serial Port I/O port address is 2F8h and the interrupt address is IRQ3, 4
- ➔ **IO=3E8h;**
IRQ=3, 4 Serial Port I/O port address is 3E8h and the interrupt address is IRQ3, 4
- ➔ **IO=2E8h;**
IRQ=3, 4 Serial Port I/O port address is 2E8h and the interrupt address is IRQ3, 4

5.3.6.1.2 Serial Port 2 Configuration

➔ Serial Port [Enabled]

Use the **Serial Port** option to enable or disable the serial port.

- ➔ **Disabled** Disable the serial port
- ➔ **Enabled** **DEFAULT** Enable the serial port

➔ Change Settings [Auto]

Use the **Change Settings** option to change the serial port IO port address and interrupt address.

- ➔ **Auto** **DEFAULT** The serial port IO port address and interrupt address are automatically detected.
- ➔ **IO=2F8h;**
IRQ=3 Serial Port I/O port address is 2F8h and the interrupt address is IRQ3
- ➔ **IO=3F8h;**
IRQ=3, 4 Serial Port I/O port address is 3F8h and the interrupt address is IRQ3, 4
- ➔ **IO=2F8h;**
IRQ=3, 4 Serial Port I/O port address is 2F8h and the interrupt address is IRQ3, 4
- ➔ **IO=3E8h;**
IRQ=3, 4 Serial Port I/O port address is 3E8h and the interrupt address is IRQ3, 4
- ➔ **IO=2E8h;**
IRQ=3, 4 Serial Port I/O port address is 2E8h and the interrupt address is IRQ3, 4

5.3.6.1.3 Serial Port 3 Configuration

➔ Serial Port [Enabled]

Use the **Serial Port** option to enable or disable the serial port.

- ➔ **Disabled** Disable the serial port
- ➔ **Enabled** **DEFAULT** Enable the serial port

➔ Change Settings [Auto]

Use the **Change Settings** option to change the serial port IO port address and interrupt address.

- ➔ **Auto** **DEFAULT** The serial port IO port address and interrupt address are automatically detected.
- ➔ **IO=3E8h;**
IRQ=10 Serial Port I/O port address is 3E8h and the interrupt address is IRQ10
- ➔ **IO=3F8h;**
IRQ=10, 11 Serial Port I/O port address is 3F8h and the interrupt address is IRQ10, 11
- ➔ **IO=2F8h;**
IRQ=10, 11 Serial Port I/O port address is 2F8h and the interrupt address is IRQ10, 11
- ➔ **IO=3E8h;**
IRQ=10, 11 Serial Port I/O port address is 3E8h and the interrupt address is IRQ10, 11
- ➔ **IO=2E8h;**
IRQ=10, 11 Serial Port I/O port address is 2E8h and the interrupt address is IRQ10, 11
- ➔ **IO=250h;**
IRQ=10, 11 Serial Port I/O port address is 250h and the interrupt address is IRQ10, 11
- ➔ **IO=2E0h;**
IRQ=10, 11 Serial Port I/O port address is 2E0h and the interrupt address is IRQ10, 11

5.3.6.1.4 Serial Port 4 Configuration

➔ Serial Port [Enabled]

Use the **Serial Port** option to enable or disable the serial port.

- ➔ **Disabled** Disable the serial port
- ➔ **Enabled DEFAULT** Enable the serial port

➔ Change Settings [Auto]

Use the **Change Settings** option to change the serial port IO port address and interrupt address.

- ➔ **Auto DEFAULT** The serial port IO port address and interrupt address are automatically detected.
- ➔ **IO=2E8h;
IRQ=10** Serial Port I/O port address is 2E8h and the interrupt address is IRQ10
- ➔ **IO=3F8h;
IRQ=10, 11** Serial Port I/O port address is 3F8h and the interrupt address is IRQ10, 11
- ➔ **IO=2F8h;
IRQ=10, 11** Serial Port I/O port address is 2F8h and the interrupt address is IRQ10, 11
- ➔ **IO=3E8h;
IRQ=10, 11** Serial Port I/O port address is 3E8h and the interrupt address is IRQ10, 11
- ➔ **IO=2E8h;
IRQ=10, 11** Serial Port I/O port address is 2E8h and the interrupt address is IRQ10, 11
- ➔ **IO=250h;
IRQ=10, 11** Serial Port I/O port address is 250h and the interrupt address is IRQ10, 11
- ➔ **IO=2E0h;
IRQ=10, 11** Serial Port I/O port address is 2E0h and the interrupt address is IRQ10, 11

5.3.7 F81866 H/W Monitor

The **F81866 H/W Monitor** menu (**BIOS Menu 10**) contains the fan configuration submenus and displays operating temperature, fan speeds and system voltages.

```

Aptio Setup Utility - Copyright (C) 2011 American Megatrends, Inc.
-----
Advanced
-----
PC Health Status
> Smart Fan Mode Configuration
System Temperature      : +49 C
CPU_FAN1 Speed         : N/A
SYS_FAN1 Speed         : N/A
+VCC_CPU                : +1.200 V
+VCC_GFX                : +1.680 V
+V1.05S                 : +1.056 V
+V1.5_DDR3              : +1.520 V
VSB5V                   : +4.968 V
+V3.3S                  : +3.360 V
VSB3V                   : +3.392 V
VBAT                    : +3.264 V

Smart Fan Mode Select
-----
-><: Select Screen
↑↓: Select Item
Enter: Select
+/-: Change Opt.
F1: General Help
F2: Previous Values
F3: Optimized Defaults
F4: Save & Exit
ESC: Exit

Version 2.14.1219. Copyright (C) 2011 American Megatrends, Inc.
    
```

BIOS Menu 10: F81866 H/W Monitor

→ PC Health Status

The following system parameters and values are shown. The system parameters that are monitored are:

- System Temperatures:
 - System Temperature
- Fan Speeds:
 - CPU Fan Speed
 - System Fan Speed
- Voltages:
 - +VCC_CPU
 - +VCC_GFX
 - +V1.05S
 - +1.5_DDR3
 - VSB5V
 - +V3.3S

- VSB3V
- VBAT

5.3.7.1 Smart Fan Mode Configuration

Use the **Smart Fan Mode Configuration** submenu (**BIOS Menu 11**) to configure fan temperature and speed settings.

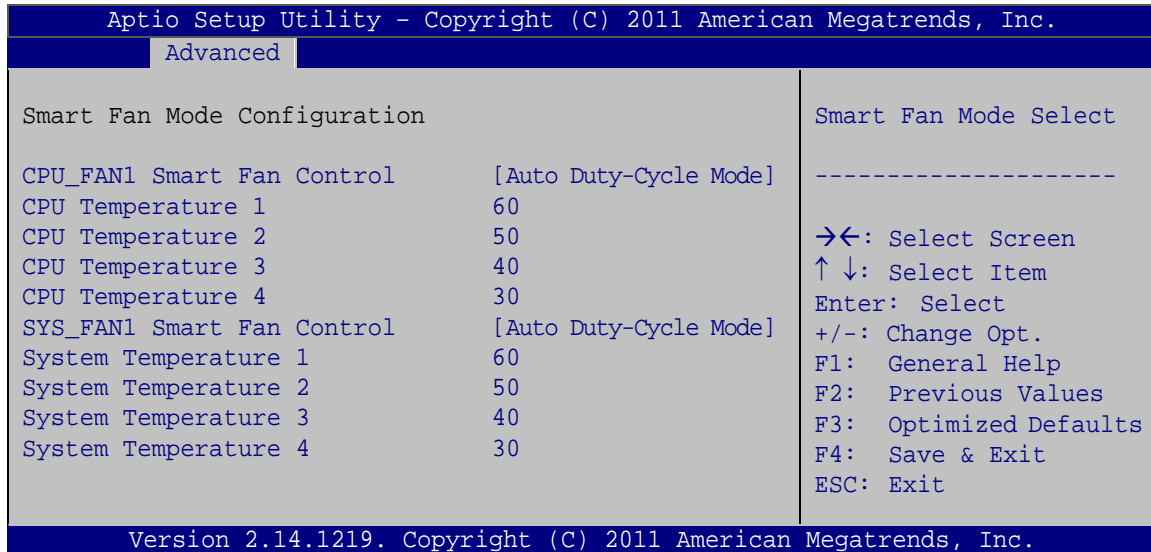

BIOS Menu 11: Smart Fan Mode Configuration

→ CPU_FAN1/SYS_FAN1 Smart Fan Control [Auto Duty-Cycle Mode]

Use the **CPU_FAN1** or **SYS_FAN1 Smart Fan Control** option to configure the CPU or System Smart Fan.

- **Auto Duty-Cycle Mode** **DEFAULT** The fan adjusts its speed using Auto Duty-Cycle settings
- **Manual Duty Mode** The fan spins at the speed set in Manual Duty Mode settings

→ CPU/System Temperature n

Use the + or – key to change the fan **CPU** or **System Temperature n** value. Enter a decimal number between 1 and 100.

5.3.8 Serial Port Console Redirection

The **Serial Port Console Redirection** menu (**BIOS Menu 12**) allows the console redirection options to be configured. Console redirection allows users to maintain a system remotely by re-directing keyboard input and text output through the serial port.

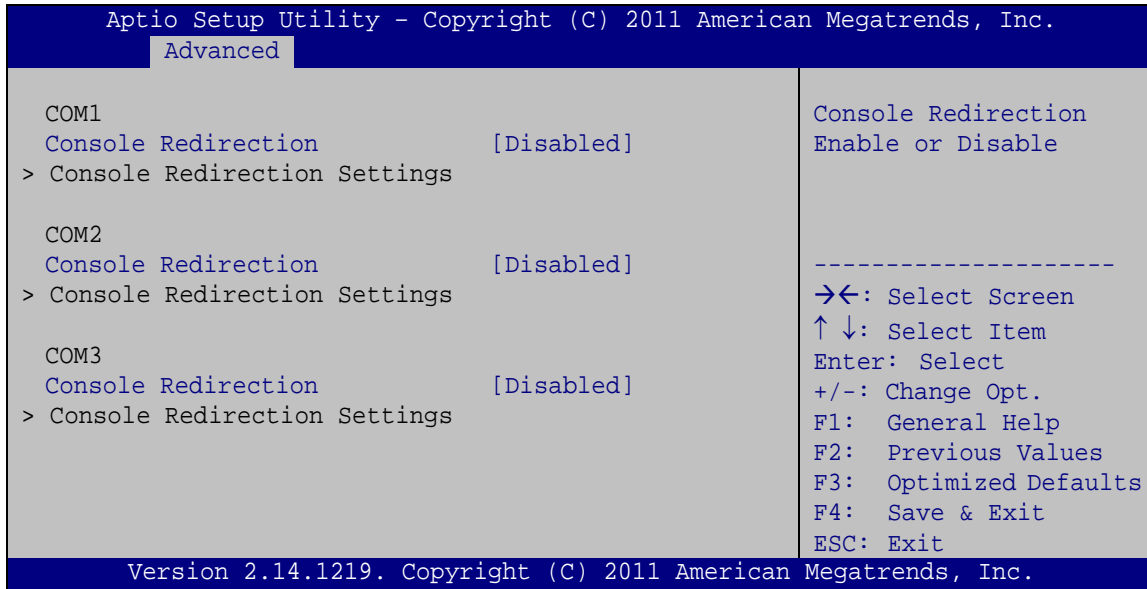

BIOS Menu 12: Serial Port Console Redirection

→ Console Redirection [Disabled]

Use **Console Redirection** option to enable or disable the console redirection function.

- **Disabled** **DEFAULT** Disabled the console redirection function
- **Enabled** Enabled the console redirection function

→ Terminal Type [ANSI]

Use the **Terminal Type** option to specify the remote terminal type.

- **VT100** The target terminal type is VT100
- **VT100+** The target terminal type is VT100+
- **VT-UTF8** The target terminal type is VT-UTF8
- **ANSI** **DEFAULT** The target terminal type is ANSI

ECN-360A-D2550 Embedded System

→ Bits per second [115200]

Use the **Bits per second** option to specify the serial port transmission speed. The speed must match the other side. Long or noisy lines may require lower speeds.

- **9600** Sets the serial port transmission speed at 9600.
- **19200** Sets the serial port transmission speed at 19200.
- **38400** Sets the serial port transmission speed at 38400.
- **57600** Sets the serial port transmission speed at 57600.
- **115200** **DEFAULT** Sets the serial port transmission speed at 115200.

→ Data Bits [8]

Use the **Data Bits** option to specify the number of data bits.

- **7** Sets the data bits at 7.
- **8** **DEFAULT** Sets the data bits at 8.

→ Parity [None]

Use the **Parity** option to specify the parity bit that can be sent with the data bits for detecting the transmission errors.

- **None** **DEFAULT** No parity bit is sent with the data bits.
- **Even** The parity bit is 0 if the number of ones in the data bits is even.
- **Odd** The parity bit is 0 if the number of ones in the data bits is odd.
- **Mark** The parity bit is always 1. This option does not provide error detection.
- **Space** The parity bit is always 0. This option does not provide error detection.

5.4 Chipset

Use the **Chipset** menu (**BIOS Menu 14**) to access the Host Bridge and Southbridge configuration menus.



WARNING!

Setting the wrong values for the Chipset BIOS selections in the Chipset BIOS menu may cause the system to malfunction.

```
Aptio Setup Utility - Copyright (C) 2011 American Megatrends, Inc.
Main   Advanced  Chipset  Boot   Security  Save & Exit
-----
> Host Bridge
> South Bridge

Host Bridge Parameters
-----
-><: Select Screen
↑ ↓: Select Item
Enter: Select
+/-: Change Opt.
F1: General Help
F2: Previous Values
F3: Optimized Defaults
F4: Save & Exit
ESC: Exit

Version 2.14.1219. Copyright (C) 2011 American Megatrends, Inc.
```

BIOS Menu 14: Chipset

5.4.1 Host Bridge Configuration

Use the **Host Bridge Configuration** menu (**BIOS Menu 15**) to configure the Intel IGD Configuration and display the memory information.

```

Aptio Setup Utility - Copyright (C) 2011 American Megatrends, Inc.
  Chipset
  > Intel IGD Configuration
  ***** Memory Information *****
  Memory Frequency           1067 MHz(DDR3)
  Total Memory               1024 MB
  DIMM#1                     1024 MB

  Config Intel IGD Settings

  -----
  →←: Select Screen
  ↑↓: Select Item
  Enter: Select
  +/-: Change Opt.
  F1: General Help
  F2: Previous Values
  F3: Optimized Defaults
  F4: Save & Exit
  ESC: Exit

  Version 2.14.1219. Copyright (C) 2011 American Megatrends, Inc.
    
```

BIOS Menu 15: Host Bridge Configuration

5.4.1.1 Intel IGD Configuration

Use the **Intel IGD Configuration** submenu (**BIOS Menu 16**) to configure the video device connected to the system.

```

Aptio Setup Utility - Copyright (C) 2011 American Megatrends, Inc.
  Advanced
  Intel IGD Configuration
  IGFX - Boot Type           [VBIOS Default]
  LVDS1 Panel Type          [800x600 LVDS]
  Backlight Control         [Inverted]
  Fixed Graphics Memory Size [128MB]

  Select the Video Device which will be activated during POST. This has no effect if external graphics present.

  -----
  →←: Select Screen
  ↑↓: Select Item
  Enter: Select
  +/-: Change Opt.
  F1: General Help
  F2: Previous Values
  F3: Optimized Defaults
  F4: Save & Exit
  ESC: Exit

  Version 2.14.1219. Copyright (C) 2011 American Megatrends, Inc.
    
```

BIOS Menu 16: Intel IGD Configuration

ECN-360A-D2550 Embedded System

→ IGFX - Boot Type [VBIOS Default]

Use the **IGFX - Boot Type** option to select the display device used by the system when it boots. Configuration options are listed below.

- VBIOS Default **DEFAULT**
- CRT1
- CRT2
- LVDS1

→ LVDS1 Panel Type [800x600 LVDS]

Use the **LVDS1 Panel Type** option to select the type of flat panel connected to the system. Configuration options are listed below.

- 640x480 LVDS
- 800x600 LVDS **DEFAULT**
- 1024x768 LVDS
- 1280x1024 LVDS
- 1366x768 LVDS
- 1224x600 LVDS
- 1280x800 LVDS

→ Backlight Control [Inverted]

Use the **Backlight Control** option to select the backlight control mode.

- **Normal** Brightest at high voltage level
- **Inverted** **DEFAULT** Brightest at low voltage level

→ Fixed Graphics Memory Size [128MB]

Use the **Fixed Graphics Memory Size** option to specify the maximum amount of memory that can be allocated as graphics memory. Configuration options are listed below.

- 128MB **DEFAULT**
- 256MB

5.4.2 South Bridge Configuration

Use the **South Bridge Configuration** menu (**BIOS Menu 17**) to configure the Southbridge chipset.

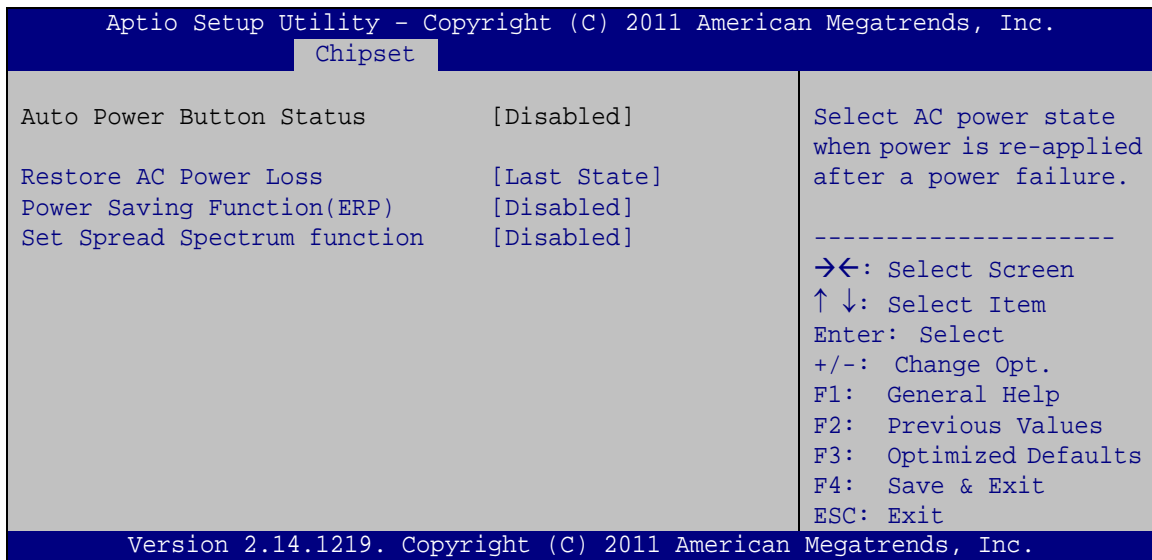

BIOS Menu 17: South Bridge Configuration

→ Restore AC Power Loss [Last State]

Use the **Restore AC Power Loss** BIOS option to specify what state the system returns to if there is a sudden loss of power to the system.

- **Power Off** The system remains turned off
- **Power On** The system turns on
- **Last State** **DEFAULT** The system returns to its previous state. If it was on, it turns itself on. If it was off, it remains off.

→ Power Saving Function(ERP) [Disabled]

Use the **Power Saving Function(ERP)** option to enable or disable the power saving function.

- **Disabled** **DEFAULT** Disables the power saving function.
- **Enabled** Enables the power saving function.

ECN-360A-D2550 Embedded System

- ➔ Set Spread Spectrum Function [Disabled]

The **Set Spread Spectrum Function** option can help to improve CPU EMI issues.

- ➔ **Disabled** **DEFAULT** The spread spectrum mode is disabled
- ➔ **Enabled** The spread spectrum mode is enabled

5.5 Boot

Use the **Boot menu (BIOS Menu 18)** to configure system boot options.

```

Aptio Setup Utility - Copyright (C) 2011 American Megatrends, Inc.
Main      Advanced  Chipset   Boot      Security  Save & Exit
-----
Boot Configuration
Bootup NumLock State      [On]
Quiet Boot                 [Enabled]
Launch PXE OpROM          [Disabled]
Option ROM Messages       [Force BIOS]
UEFI Boot                  [Disabled]

Boot Option Priorities

-----
-><: Select Screen
↑ ↓: Select Item
Enter: Select
+/-: Change Opt.
F1:  General Help
F2:  Previous Values
F3:  Optimized Defaults
F4:  Save & Exit
ESC: Exit

Version 2.14.1219. Copyright (C) 2011 American Megatrends, Inc.

```

BIOS Menu 18: Boot

- ➔ Bootup NumLock State [On]

Use the **Bootup NumLock State** BIOS option to specify if the number lock setting must be modified during boot up.

- ➔ **On** **DEFAULT** Allows the Number Lock on the keyboard to be enabled automatically when the computer system boots up. This allows the immediate use of the 10-key numeric keypad located on the right side of the keyboard. To confirm this, the Number Lock LED light on the keyboard is lit.

→ **Off** Does not enable the keyboard Number Lock automatically. To use the 10-keys on the keyboard, press the Number Lock key located on the upper left-hand corner of the 10-key pad. The Number Lock LED on the keyboard lights up when the Number Lock is engaged.

→ **Quiet Boot [Enabled]**

Use the **Quiet Boot** BIOS option to select the screen display when the system boots.

→ **Disabled** Normal POST messages displayed

→ **Enabled** **DEFAULT** OEM Logo displayed instead of POST messages

→ **Launch PXE OpROM [Disabled]**

Use the **Launch PXE OpROM** option to enable or disable boot option for legacy network devices.

→ **Disabled** **DEFAULT** Ignore all PXE Option ROMs

→ **Enabled** Load PXE Option ROMs.

→ **Option ROM Messages [Force BIOS]**

Use the **Option ROM Messages** option to set the Option ROM display mode.

→ **Force BIOS** **DEFAULT** Sets display mode to force BIOS.

→ **Keep Current** Sets display mode to current.

→ **UEFI Boot [Disabled]**

Use the **UEFI Boot** BIOS option to allow the system to boot from the UEFI devices.

→ **Disabled** **DEFAULT** Disables to boot from the UEFI devices.

→ **Enabled** Enables to boot from the UEFI devices.

5.6 Security

Use the **Security** menu (**BIOS Menu 19**) to set system and user passwords.

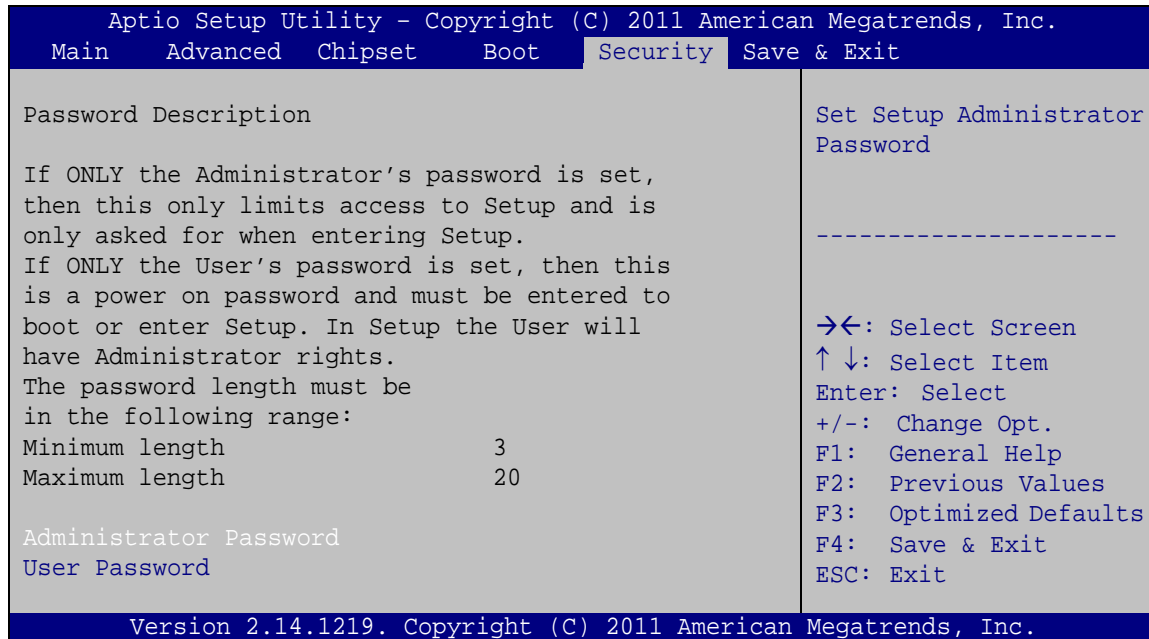

BIOS Menu 19: Security

→ Administrator Password

Use the **Administrator Password** to set or change an administrator password.

→ User Password

Use the **User Password** to set or change a user password.

5.7 Save & Exit

Use the **Save & Exit** menu (**BIOS Menu 20**) to load default BIOS values, optimal failsafe values and to save configuration changes.

```

Aptio Setup Utility - Copyright (C) 2011 American Megatrends, Inc.
Main   Advanced  Chipset  Boot   Security  Save & Exit

Save Changes and Reset
Discard Changes and Reset

Restore Defaults
Save as User Defaults
Restore User Defaults

Reset the system after
saving the changes.

-----
-><: Select Screen
↑↓: Select Item
Enter: Select
+/-: Change Opt.
F1:  General Help
F2:  Previous Values
F3:  Optimized Defaults
F4:  Save & Exit
ESC: Exit

Version 2.14.1219. Copyright (C) 2011 American Megatrends, Inc.
    
```

BIOS Menu 20: Save & Exit

→ Save Changes and Reset

Use the **Save Changes and Reset** option to save the changes made to the BIOS options and reset the system.

→ Discard Changes and Reset

Use the **Discard Changes and Reset** option to exit the system without saving the changes made to the BIOS configuration setup program.

→ Restore Defaults

Use the **Restore Defaults** option to load the optimal default values for each of the parameters on the Setup menus. **F3 key can be used for this operation.**

→ Save as User Defaults

Use the **Save as User Defaults** option to save the changes done so far as user defaults.

→ Restore User Defaults

Use the **Restore User Defaults** option to restore the user defaults to all the setup options.

Appendix

A

Safety Precautions

**WARNING:**

The precautions outlined in this chapter should be strictly followed. Failure to follow these precautions may result in permanent damage to the ECN-360A-D2550.

A.1 Safety Precautions

Please follow the safety precautions outlined in the sections that follow:

A.1.1 General Safety Precautions

Please ensure the following safety precautions are adhered to at all times.

- **Follow the electrostatic precautions** outlined below whenever the ECN-360A-D2550 is opened.
- **Make sure the power is turned off and the power cord is disconnected** whenever the ECN-360A-D2550 is being installed, moved or modified.
- **Do not apply voltage levels that exceed the specified voltage range.** Doing so may cause fire and/or an electrical shock.
- **Electric shocks can occur** if the ECN-360A-D2550 chassis is opened when the ECN-360A-D2550 is running.
- **Do not drop or insert any objects** into the ventilation openings of the ECN-360A-D2550.
- **If considerable amounts of dust, water, or fluids enter the ECN-360A-D2550**, turn off the power supply immediately, unplug the power cord, and contact the ECN-360A-D2550 vendor.
- **DO NOT:**
 - Drop the ECN-360A-D2550 against a hard surface.
 - Strike or exert excessive force onto the ECN-360A-D2550.
 - Touch any of the ECN-360A-D2550 with a sharp object
 - In a site where the ambient temperature exceeds the rated temperature

A.1.2 Anti-static Precautions

**WARNING:**

Failure to take ESD precautions during the installation of the ECN-360A-D2550 may result in permanent damage to the ECN-360A-D2550 and severe injury to the user.

Electrostatic discharge (ESD) can cause serious damage to electronic components, including the ECN-360A-D2550. Dry climates are especially susceptible to ESD. It is therefore critical that whenever the ECN-360A-D2550 is opened and any of the electrical components are handled, the following anti-static precautions are strictly adhered to.

- ***Wear an anti-static wristband:*** Wearing a simple anti-static wristband can help to prevent ESD from damaging any electrical component.
- ***Self-grounding:*** Before handling any electrical component, touch any grounded conducting material. During the time the electrical component is handled, frequently touch any conducting materials that are connected to the ground.
- ***Use an anti-static pad:*** When configuring or working with an electrical component, place it on an anti-static pad. This reduces the possibility of ESD damage.
- ***Only handle the edges of the electrical component:*** When handling the electrical component, hold the electrical component by its edges.

A.1.3 Product Disposal

**CAUTION:**

Risk of explosion if battery is replaced by and incorrect type. Only certified engineers should replace the on-board battery.

Dispose of used batteries according to instructions and local regulations.

- Outside the European Union - If you wish to dispose of used electrical and electronic products outside the European Union, please contact your local authority so as to comply with the correct disposal method.
- Within the European Union:

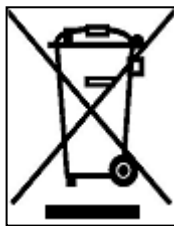

EU-wide legislation, as implemented in each Member State, requires that waste electrical and electronic products carrying the mark (left) must be disposed of separately from normal household waste. This includes monitors and electrical accessories, such as signal cables or power cords.

When you need to dispose of your display products, please follow the guidance of your local authority, or ask the shop where you purchased the product. The mark on electrical and electronic products only applies to the current European Union Member States.

Please follow the national guidelines for electrical and electronic product disposal.

A.2 Maintenance and Cleaning Precautions

When maintaining or cleaning the ECN-360A-D2550, please follow the guidelines below.

A.2.1 Maintenance and Cleaning

Prior to cleaning any part or component of the ECN-360A-D2550, please read the details below.

ECN-360A-D2550 Embedded System

- The interior of the ECN-360A-D2550X does not require cleaning. Keep fluids away from the ECN-360A-D2550 interior.
- Be cautious of all small removable components when vacuuming the ECN-360A-D2550.
- Turn the ECN-360A-D2550 off before cleaning the ECN-360A-D2550.
- Never drop any objects or liquids through the openings of the ECN-360A-D2550.
- Be cautious of any possible allergic reactions to solvents or chemicals used when cleaning the ECN-360A-D2550.
- Avoid eating, drinking and smoking within vicinity of the ECN-360A-D2550.

A.2.2 Cleaning Tools

Some components in the ECN-360A-D2550 may only be cleaned using a product specifically designed for the purpose. In such case, the product will be explicitly mentioned in the cleaning tips. Below is a list of items to use when cleaning the ECN-360A-D2550.

- **Cloth** – Although paper towels or tissues can be used, a soft, clean piece of cloth is recommended when cleaning the ECN-360A-D2550.
- **Water or rubbing alcohol** – A cloth moistened with water or rubbing alcohol can be used to clean the LECN-360A-D2550.
- **Using solvents** – The use of solvents is not recommended when cleaning the LECN-360A-D2550 as they may damage the plastic parts.
- **Vacuum cleaner** – Using a vacuum specifically designed for computers is one of the best methods of cleaning the ECN-360A-D2550. Dust and dirt can restrict the airflow in the ECN-360A-D2550 and cause its circuitry to corrode.
- **Cotton swabs** - Cotton swaps moistened with rubbing alcohol or water are excellent tools for wiping hard to reach areas.
- **Foam swabs** - Whenever possible, it is best to use lint free swabs such as foam swabs for cleaning.



Appendix

B

BIOS Menu Options

- ➔ System Overview50
- ➔ System Date [xx/xx/xx]50
- ➔ System Time [xx:xx:xx]51
- ➔ ACPI Sleep State [S1 (CPU Stop Clock)]52
- ➔ Wake system with Fixed Time [Disabled].....53
- ➔ Hyper-Threading [Enabled].....55
- ➔ Configure SATA as [IDE].....55
- ➔ USB Devices56
- ➔ Legacy USB Support [Enabled].....56
- ➔ Serial Port [Enabled].....58
- ➔ Change Settings [Auto]58
- ➔ Serial Port [Enabled].....59
- ➔ Change Settings [Auto]59
- ➔ Serial Port [Enabled].....60
- ➔ Change Settings [Auto]60
- ➔ Serial Port [Enabled].....61
- ➔ Change Settings [Auto]61
- ➔ PC Health Status62
- ➔ CPU_FAN1/SYS_FAN1 Smart Fan Control [Auto Duty-Cycle Mode].....63
- ➔ CPU/System Temperature n.....63
- ➔ Console Redirection [Disabled].....64
- ➔ Terminal Type [ANSI].....64
- ➔ Bits per second [115200].....65
- ➔ Data Bits [8]65
- ➔ Parity [None].....65
- ➔ Stop Bits [1].....66
- ➔ Auto Recovery Function [Disabled]66
- ➔ IGFX - Boot Type [VBIOS Default]69
- ➔ LVDS1 Panel Type [800x600 LVDS]69
- ➔ Backlight Control [Inverted].....69
- ➔ Fixed Graphics Memory Size [128MB].....69
- ➔ Restore AC Power Loss [Last State]70
- ➔ Power Saving Function(ERP) [Disabled].....70
- ➔ Set Spread Spectrum Function [Disabled].....71

→	Bootup NumLock State [On].....	71
→	Quiet Boot [Enabled]	72
→	Launch PXE OpROM [Disabled]	72
→	Option ROM Messages [Force BIOS].....	72
→	UEFI Boot [Disabled]	72
→	Administrator Password	73
→	User Password	73
→	Save Changes and Reset	74
→	Discard Changes and Reset	74
→	Restore Defaults	74
→	Save as User Defaults	74
→	Restore User Defaults	74

Appendix

C

One Key Recovery

C.1 One Key Recovery Introduction

The IEI one key recovery is an easy-to-use front end for the Norton Ghost system backup and recovery tool. This tool provides quick and easy shortcuts for creating a backup and reverting to that backup or reverting to the factory default settings.



NOTE:

The latest One Key Recovery software provides an auto recovery function that allows a system running Microsoft Windows OS to automatically restore from the factory default image after encountering a Blue Screen of Death (BSoD) or a hang for around 10 minutes. Please refer to Section C.3 for the detailed setup procedure.

The IEI One Key Recovery tool menu is shown below.

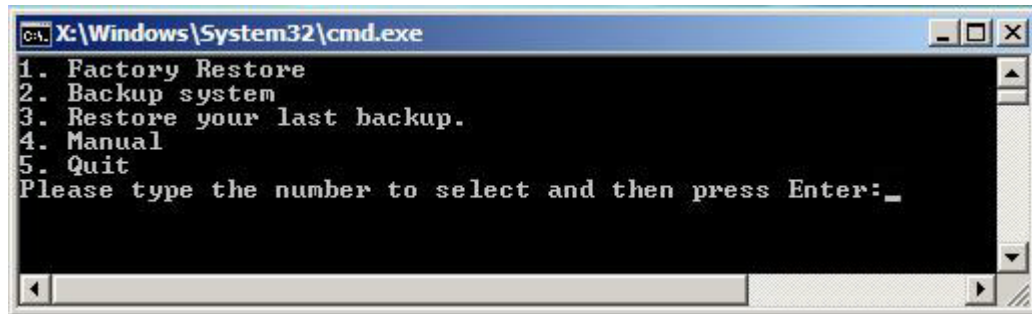

Figure C-1: IEI One Key Recovery Tool Menu

Prior to using the IEI One Key Recovery tool (as shown in **Figure C-1**) to backup or restore Windows system, five setup procedures are required.

1. Hardware and BIOS setup (see **Section C.2.1**)
2. Create partitions (see **Section C.2.2**)
3. Install operating system, drivers and system applications (see **Section C.2.3**)
4. Build the recovery partition (see **Section C.2.4**)
5. Create factory default image (see **Section C.2.5**)

ECN-360A-D2550 Embedded System

After completing the five initial setup procedures as described above, users can access the recovery tool by pressing <F3> while booting up the system. The detailed information of each function is described in **Section C.5**.



NOTE:

The initial setup procedures for Linux system are described in **Section C.3**.

C.1.1 System Requirement



NOTE:

The recovery CD can only be used with IEI products. The software will fail to run and a warning message will appear when used on non-IEI hardware.

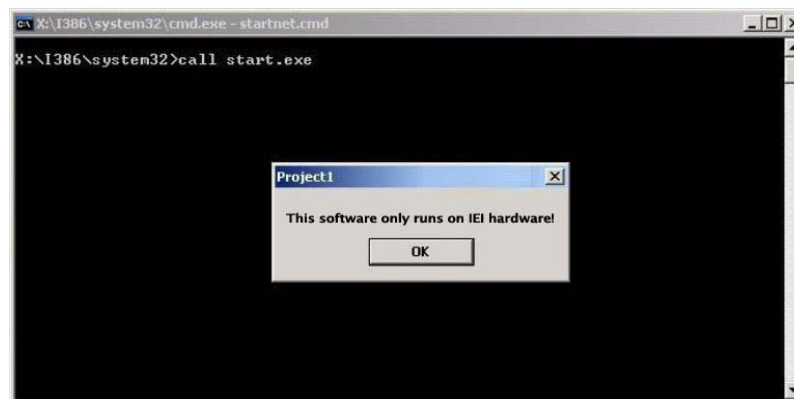

To create the system backup, the main storage device must be split into two partitions (three partitions for Linux). The first partition will be for the operating system, while the second partition will be invisible to the operating system and contain the backup made by the one key recovery software.

The partition created for recovery images must be big enough to contain both the factory default image and the user backup image. The size must be calculated before creating the

partitions. Please take the following table as a reference when calculating the size of the partition.

	OS	OS Image after Ghost	Compression Ratio
Windows® 7	7 GB	5 GB	70%
Windows® XPE	776 MB	560 MB	70%
Windows® CE 6.0	36 MB	28 MB	77%

NOTE:

Specialized tools are required to change the partition size if the operating system is already installed.

C.1.2 Supported Operating System

The recovery CD is compatible with both Microsoft Windows and Linux operating systems (OS). The supported OS versions are listed below.

- Microsoft Windows
 - Windows XP (Service Pack 2 or 3 required)
 - Windows Vista
 - Windows 7
 - Windows CE 5.0
 - Windows CE 6.0
 - Windows XP Embedded
- Linux
 - Fedora Core 12 (Constantine)
 - Fedora Core 11 (Leonidas)
 - Fedora Core 10 (Cambridge)
 - Fedora Core 8 (Werewolf)
 - Fedora Core 7 (Moonshine)
 - RedHat RHEL-5.4
 - RedHat 9 (Ghirke)

- Ubuntu 8.10 (Intrepid)
- Ubuntu 7.10 (Gutsy)
- Ubuntu 6.10 (Edgy)
- Debian 5.0 (Lenny)
- Debian 4.0 (Etch)
- SuSe 11.2
- SuSe 10.3

**NOTE:**

Installing unsupported OS versions may cause the recovery tool to fail.

C.2 Setup Procedure for Windows

Prior to using the recovery tool to backup or restore, a few setup procedures are required.

Step 1: Hardware and BIOS setup (see **Section C.2.1**)

Step 2: Create partitions (see **Section C.2.2**)

Step 3: Install operating system, drivers and system applications (see **Section C.2.3**)

Step 4: Build the recovery partition (see **Section C.2.4**) or build the auto recovery partition (see **Section C.3**)

Step 5: Create factory default image (see **Section C.2.5**)

The detailed descriptions are described in the following sections.

**NOTE:**

The setup procedures described below are for Microsoft Windows operating system users. For Linux, most of the setup procedures are the same except for several steps described in **Section C.3**.

C.2.1 Hardware and BIOS Setup

- Step 1:** Make sure the system is powered off and unplugged.
- Step 2:** Install a hard drive or SSD in the system. An unformatted and unpartitioned disk is recommended.
- Step 3:** Connect an optical disk drive to the system and insert the recovery CD.
- Step 4:** Turn on the system.
- Step 5:** Press the **<DELETE>** key as soon as the system is turned on to enter the BIOS.
- Step 6:** Select the connected optical disk drive as the 1st boot device. (**Boot → Boot Device Priority → 1st Boot Device**).
- Step 7:** Save changes and restart the computer. Continue to the next section for instructions on partitioning the internal storage.

C.2.2 Create Partitions

To create the system backup, the main storage device must be split into two partitions (three partitions for Linux). The first partition will be for the operating system, while the second partition will be invisible to the operating system and contain the backup made by the one key recovery software.

- Step 1:** Put the recovery CD in the optical drive of the system.
- Step 2:** **Boot the system from recovery CD.** When prompted, press any key to boot from the recovery CD. It will take a while to launch the recovery tool. Please be patient!

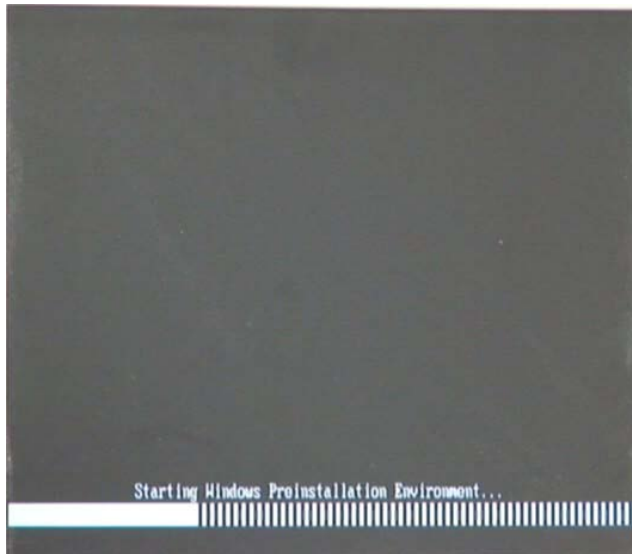

Figure C-2: Launching the Recovery Tool

Step 3: The recovery tool setup menu is shown as below.

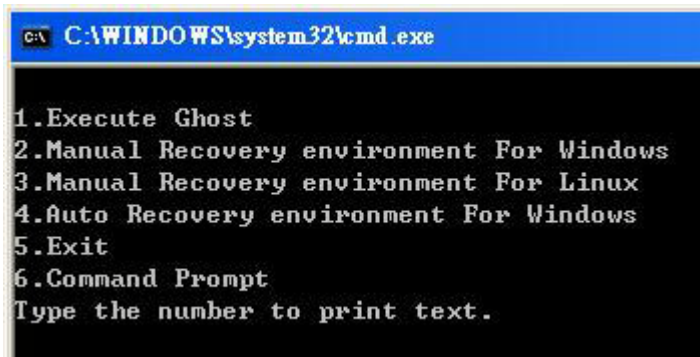
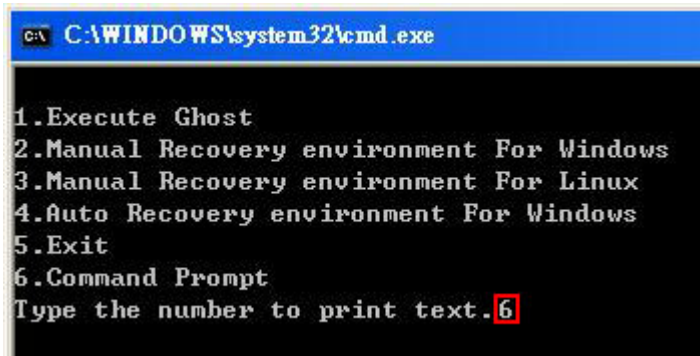

Figure C-3: Recovery Tool Setup Menu

Step 4: Press <6> then <Enter>.



```

C:\WINDOWS\system32\cmd.exe

1.Execute Ghost
2.Manual Recovery environment For Windows
3.Manual Recovery environment For Linux
4.Auto Recovery environment For Windows
5.Exit
6.Command Prompt
Type the number to print text. 6
    
```

Figure C-4: Command Prompt

Step 5: The command prompt window appears. Type the following commands (marked in red) to create two partitions. One is for the OS installation; the other is for saving recovery files and images which will be an invisible partition. (Press <Enter> after entering each line below)

```

system32>diskpart
DISKPART>list vol
DISKPART>sel disk 0
DISKPART>create part pri size= ____
DISKPART>assign letter=N
DISKPART>create part pri size= ____
DISKPART>assign letter=F
DISKPART>exit
system32>format N: /fs:ntfs /q /y
system32>format F: /fs:ntfs /q /v:Recovery /y
system32>exit
    
```

```

X:\I386\SYSTEM32\CMD.EXE
X:\I386\SYSTEM32>diskpart → Starts the Microsoft disk partitioning tool.

Microsoft DiskPart version 5.2.3790.1830
Copyright (C) 1999-2001 Microsoft Corporation.
On computer: MININT-JUC

DISKPART> list vol → Show partition information

   Volume ###  Ltr  Label          Fs          Type          Size         Status       Info
   -----  -  -  -  -  -  -  -  -  -  -
   Volume 0             X   CD_ROM        CDFS        DUD-ROM        405 MB     Healthy     Boot
   Volume 1             D                   FAT32     Removeable    3854 MB     Healthy

DISKPART> sel disk 0 → Select a disk
Disk 0 is now the selected disk.

DISKPART> create part pri size=2000 → Create partition 1 and assign a size.
                                     This partition is for OS installation.
DiskPart succeeded in creating the specified partition.

DISKPART> assign letter=N → Assign partition 1 a code name (N).
DiskPart successfully assigned the drive letter or mount point.

DISKPART> create part pri size=1800 → Create partition 2 and assign a size.
                                     This partition is for recovery images.
DiskPart succeeded in creating the specified partition.

DISKPART> assign letter=F → Assign partition 2 a code name (F).
DiskPart successfully assigned the drive letter or mount point.

DISKPART> exit → Exit diskpart

X:\I386\SYSTEM32>format n: /fs:ntfs /q /y → Format partition 1 (N) as NTFS format.
The type of the file system is RAW.
The new file system is NTFS.
QuickFormatting 2000M
Creating file system structures.
Format complete.
 2048254 KB total disk space.
 2035620 KB are available.

X:\I386\SYSTEM32>format f: /fs:ntfs /q /v:Recovery /y → Formate partition 2 (F) as NTFS formate and
                                                         name it as "Recovery".
The type of the file system is RAW.
The new file system is NTFS.
QuickFormatting 1804M
Creating file system structures.
Format complete.
 1847474 KB total disk space.
 1835860 KB are available.

X:\I386\SYSTEM32>exit → Exit Windows PE
  
```

Figure C-5: Partition Creation Commands

**NOTE:**

Use the following commands to check if the partitions were created successfully.

```
X:\I386\SYSTEM32>diskpart
Microsoft DiskPart version 5.2.3790.1830
Copyright (C) 1999-2001 Microsoft Corporation.
On computer: MININT-JUC

DISKPART> sel disk 0
Disk 0 is now the selected disk.

DISKPART> list part

   Partition ###   Type              Size              Offset
-----
   Partition 1     Primary            2000 MB           32 KB
   Partition 2     Primary            1804 MB          2000 MB

DISKPART> exit
```

Step 6: Press any key to exit the recovery tool and automatically reboot the system.

Please continue to the following procedure: Build the Recovery Partition.

C.2.3 Install Operating System, Drivers and Applications

Install the operating system onto the unlabelled partition. The partition labeled "Recovery" is for use by the system recovery tool and should not be used for installing the operating system or any applications.

**NOTE:**

The operating system installation program may offer to reformat the chosen partition. DO NOT format the partition again. The partition has already been formatted and is ready for installing the new operating system.

To install the operating system, insert the operating system installation CD into the optical drive. Restart the computer and follow the installation instructions.

C.2.4 Building the Recovery Partition

- Step 1:** Put the recover CD in the optical drive.
- Step 2:** Start the system.
- Step 3:** **Boot the system from the recovery CD.** When prompted, press any key to boot from the recovery CD. It will take a while to launch the recovery tool. Please be patient!

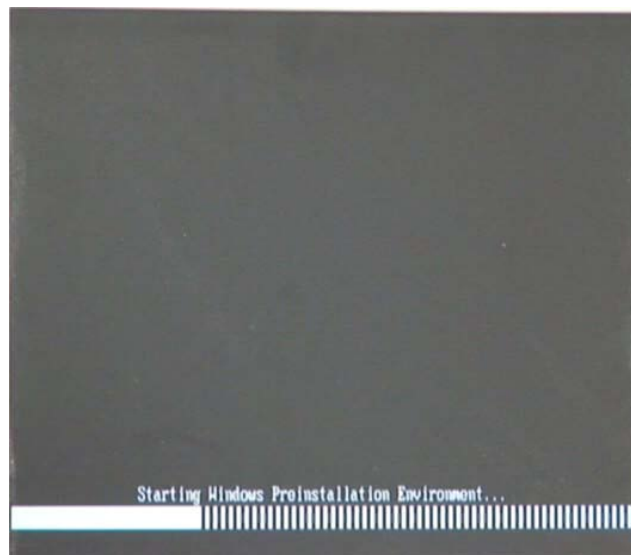

Figure C-6: Launching the Recovery Tool

- Step 4:** When the recovery tool setup menu appears, press <2> then <Enter>.

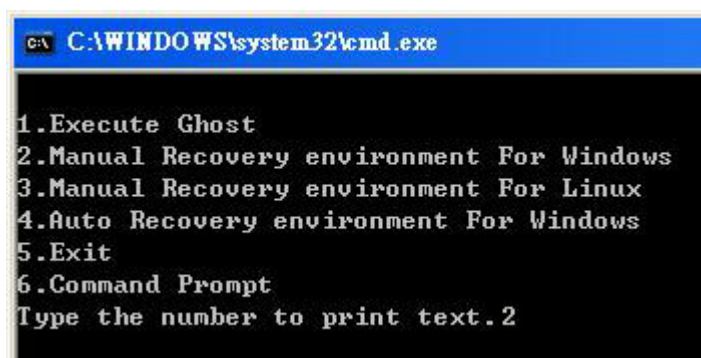

Figure C-7: Manual Recovery Environment for Windows

Step 5: The Symantec Ghost window appears and starts configuring the system to build a recovery partition. In this process the partition created for recovery files in **Section C.2.2** is hidden and the recovery tool is saved in this partition.

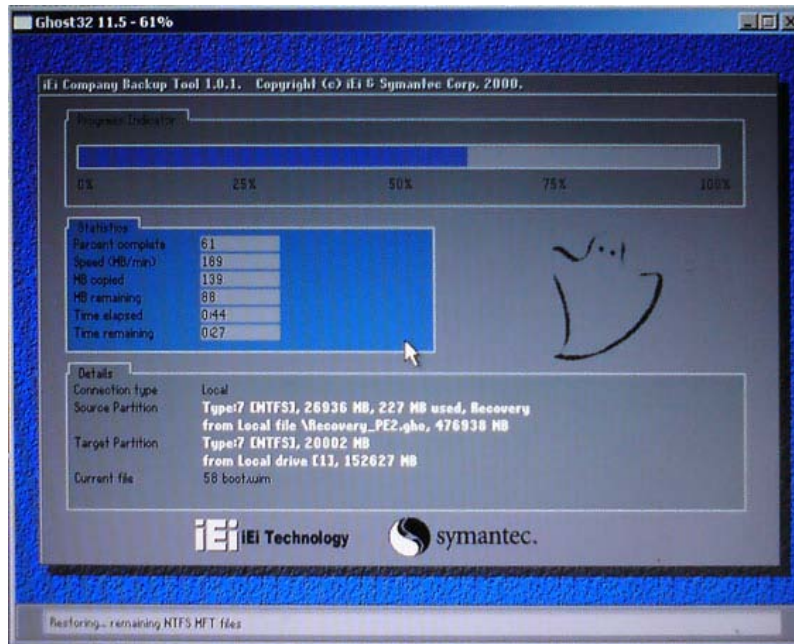

Figure C-8: Building the Recovery Partition

Step 6: After completing the system configuration, press any key in the following window to reboot the system.

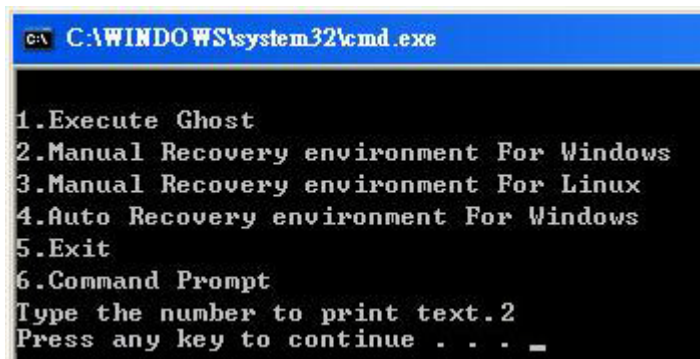

Figure C-9: Press Any Key to Continue

Step 7: Eject the recovery CD.

C.2.5 Create Factory Default Image



NOTE:

Before creating the factory default image, please configure the system to a factory default environment, including driver and application installations.

To create a factory default image, please follow the steps below.

Step 1: Turn on the system. When the following screen displays (**Figure C-10**), press the <F3> key to access the recovery tool. The message will display for 10 seconds, please press F3 before the system boots into the operating system.

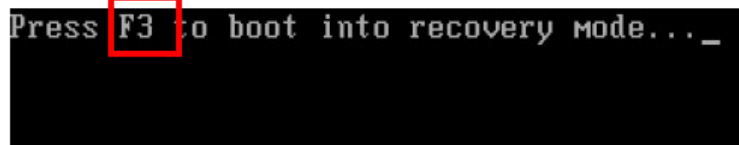

```
Press F3 to boot into recovery mode... _
```

Figure C-10: Press F3 to Boot into Recovery Mode

Step 2: The recovery tool menu appears. Type <4> and press <Enter>. (**Figure C-11**)

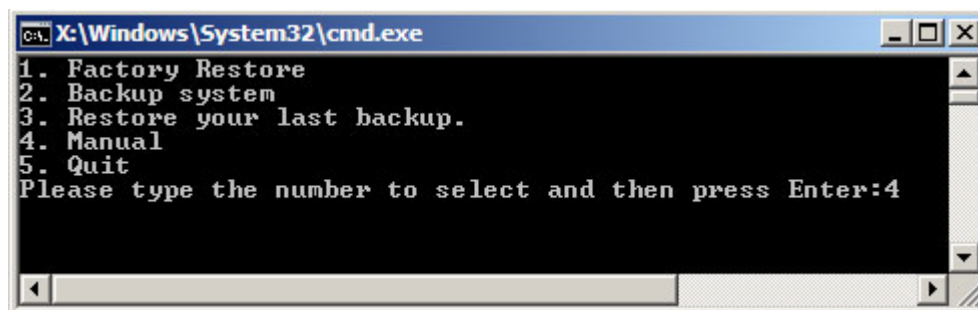

Figure C-11: Recovery Tool Menu

Step 3: The About Symantec Ghost window appears. Click **OK** button to continue.

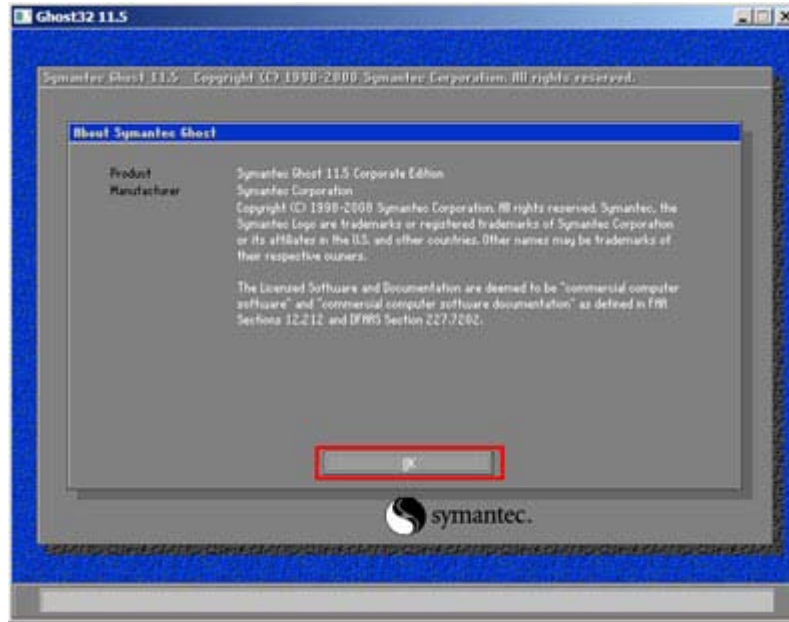

Figure C-12: About Symantec Ghost Window

Step 4: Use mouse to navigate to the option shown below (Figure C-13).

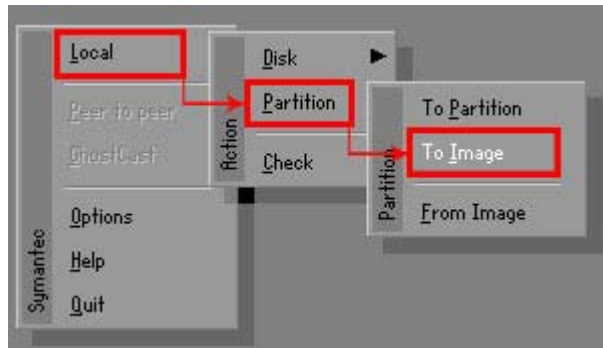

Figure C-13: Symantec Ghost Path

Step 5: Select the local source drive (Drive 1) as shown in Figure C-14. Then click OK.

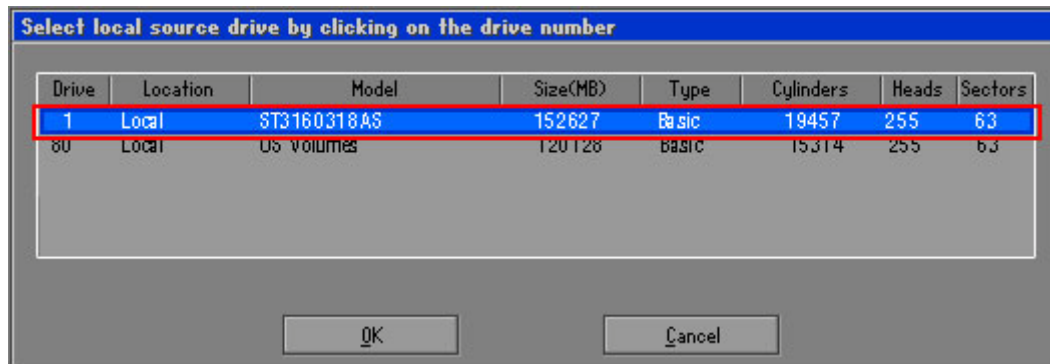

Figure C-14: Select a Local Source Drive

Step 6: Select a source partition (Part 1) from basic drive as shown in **Figure C-15**. Then click OK.

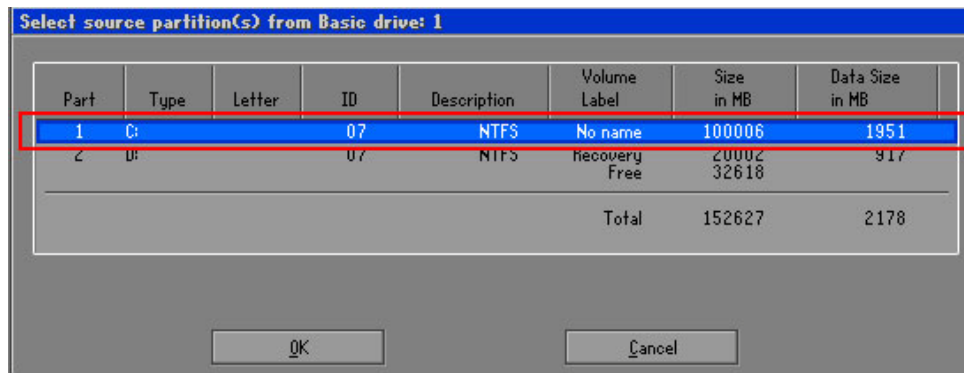

Figure C-15: Select a Source Partition from Basic Drive

Step 7: Select **1.2: [Recovery] NTFS drive** and enter a file name called **iei** (**Figure C-16**). Click **Save**. The factory default image will then be saved in the selected recovery drive and named **IEI.GHO**.



WARNING:

The file name of the factory default image must be **iei.GHO**.

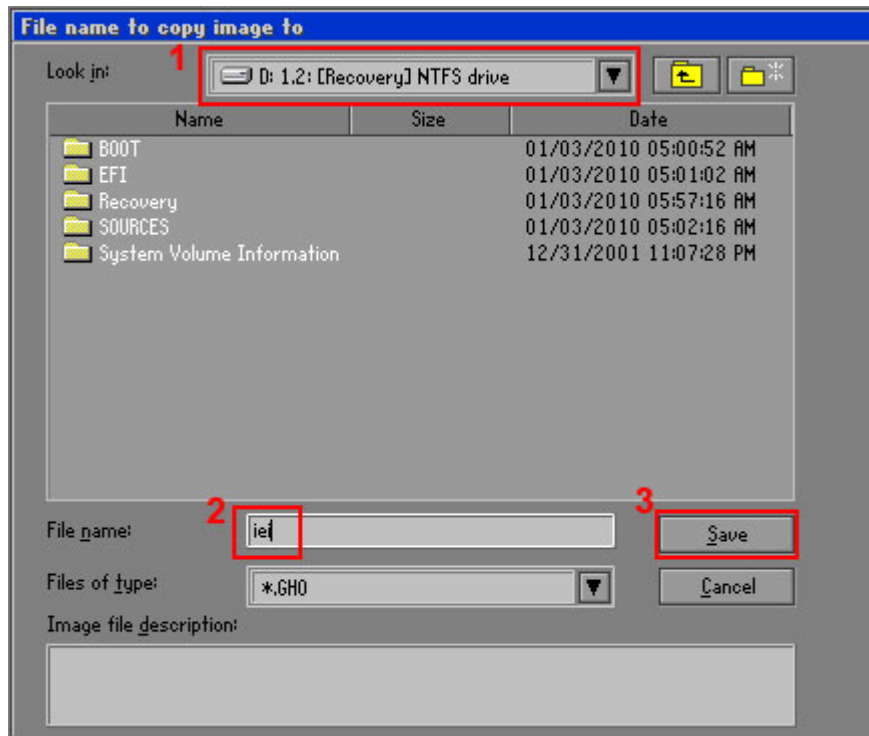

Figure C-16: File Name to Copy Image to

Step 8: When the Compress Image screen in Figure C-17 prompts, click **High** to make the image file smaller.

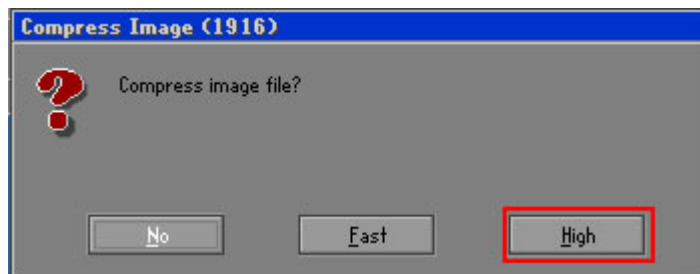

Figure C-17: Compress Image

Step 9: The Proceed with partition image creation window appears, click **Yes** to continue.

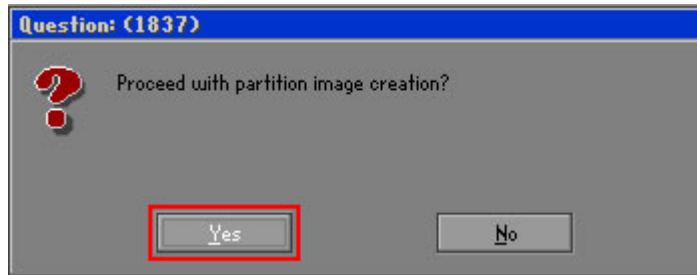

Figure C-18: Image Creation Confirmation

Step 10: The Symantec Ghost starts to create the factory default image (**Figure C-19**).

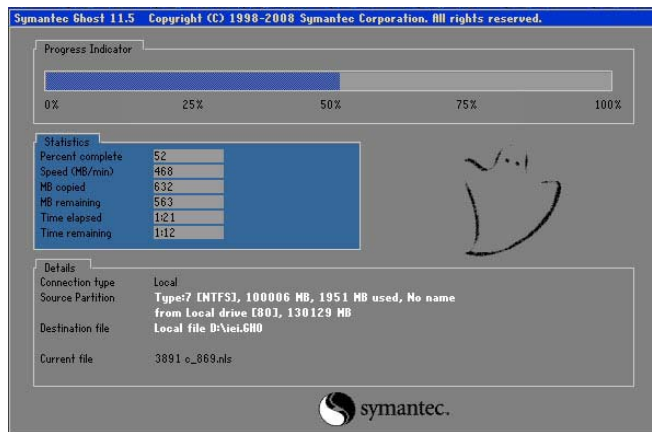

Figure C-19: Image Creation Complete

Step 11: When the image creation completes, a screen prompts as shown in **Figure C-20**.

Click **Continue** and close the Ghost window to exit the program.



Figure C-20: Image Creation Complete

Step 12: The recovery tool main menu window is shown as below. Press any key to reboot the system.

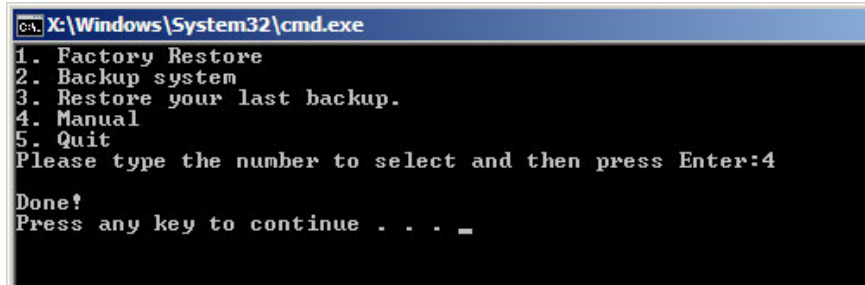

```

C:\Windows\System32\cmd.exe
1. Factory Restore
2. Backup system
3. Restore your last backup.
4. Manual
5. Quit
Please type the number to select and then press Enter:4
Done!
Press any key to continue . . . _
    
```

Figure C-21: Press Any Key to Continue

C.3 Auto Recovery Setup Procedure

The auto recovery function allows a system to automatically restore from the factory default image after encountering a Blue Screen of Death (BSoD) or a hang for around 10 minutes. To use the auto recovery function, follow the steps described in the following sections.



CAUTION:

The setup procedure may include a step to create a factory default image. It is suggested to configure the system to a factory default environment before the configuration, including driver and application installations.

Step 1: Follow the steps described in **Section C.2.1 ~ Section C.2.3** to setup BIOS, create partitions and install operating system.

Step 2: Install the auto recovery utility into the system by double clicking the **Utility/AUTORECOVERY-SETUP.exe** in the One Key Recovery CD. This utility **MUST** be installed in the system, otherwise, the system will automatically restore from the factory default image every ten (10) minutes.



Figure C-22: Auto Recovery Utility

Step 3: Reboot the system from the recovery CD. When prompted, press any key to boot from the recovery CD. It will take a while to launch the recovery tool. Please be patient!



Figure C-23: Launching the Recovery Tool

Step 4: When the recovery tool setup menu appears, press <4> then <Enter>.

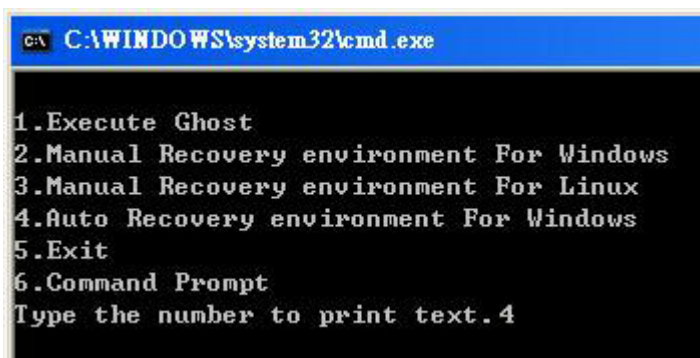

Figure C-24: Auto Recovery Environment for Windows

Step 5: The Symantec Ghost window appears and starts configuring the system to build an auto recovery partition. In this process the partition created for recovery files in **Section C.2.2** is hidden and the auto recovery tool is saved in this partition.

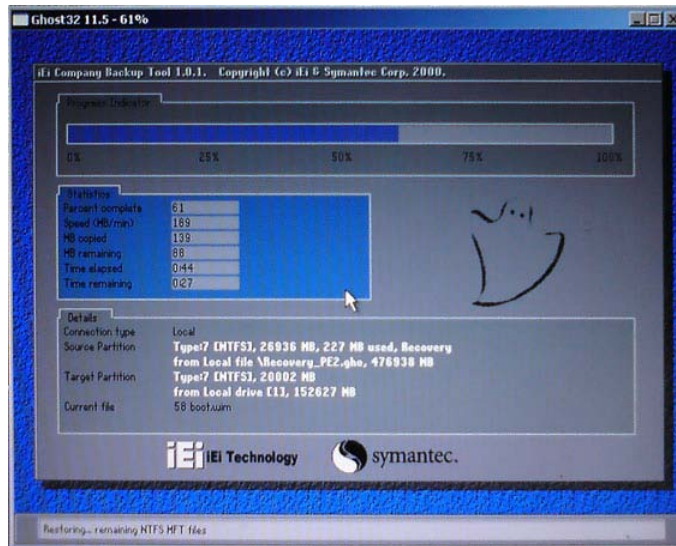

Figure C-25: Building the Auto Recovery Partition

Step 6: After completing the system configuration, the following message prompts to confirm whether to create a factory default image. Type **Y** to have the system create a factory default image automatically. Type **N** within 6 seconds to skip this process (The default option is YES). It is suggested to choose YES for this option.



Figure C-26: Factory Default Image Confirmation

Step 7: The Symantec Ghost starts to create the factory default image (**Figure C-27**).

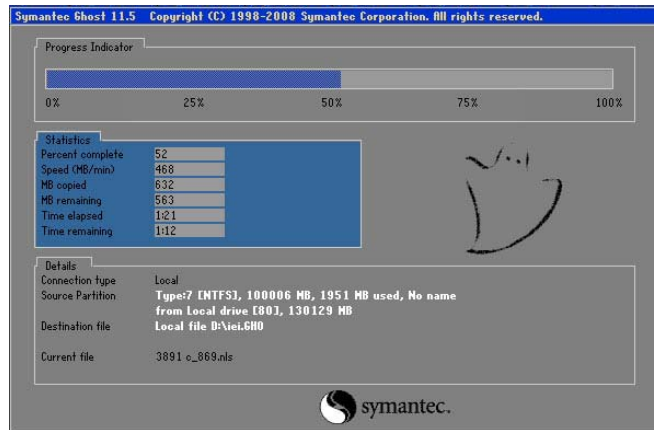

Figure C-27: Image Creation Complete

Step 8: After completing the system configuration, press any key in the following window to restart the system.

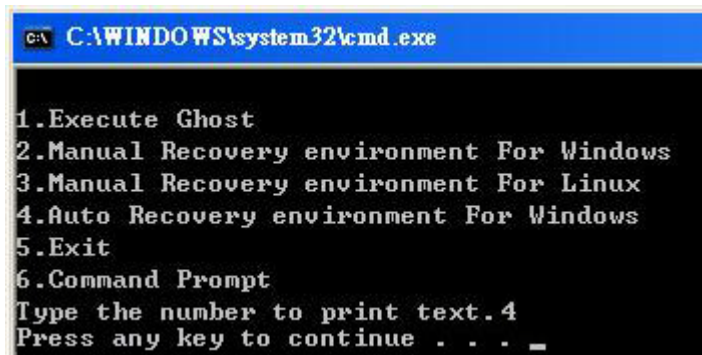

Figure C-28: Press any key to continue

Step 9: Eject the One Key Recovery CD and restart the system.

Step 10: Press the <DELETE> key as soon as the system is turned on to enter the BIOS.

Step 11: Enable the Auto Recovery Function option (**Advanced** → **iEi Feature** → **Auto Recovery Function**).

```
Aptio Setup Utility - Copyright (C) 2011 American Megatrends, Inc.
  Advanced
iEi Feature
Auto Recovery Function          [Disabled]
                                Auto Recovery Function
                                Reboot and recover
                                system automatically
                                within 10 min, when OS
                                crashes. Please install
                                Auto Recovery API
                                service before enabling
                                this function
-----
<=>: Select Screen
↑↓: Select Item
EnterSelect
+/-: Change Opt.
F1:  General Help
F2:  Previous Values
F3:  Optimized Defaults
F4:  Save & Exit
ESC: Exit
Version 2.11.1210. Copyright (C) 2011 American Megatrends, Inc.
```

BIOS Menu 21: iEi Feature

Step 12: Save changes and restart the system. If the system encounters a Blue Screen of Death (BSoD) or a hang for around 10 minutes, it will automatically restore from the factory default image.



CAUTION:

The auto recovery function can only apply on a Microsoft Windows system running the following OS versions:

- Windows XP
- Windows Vista
- Windows 7

C.4 Setup Procedure for Linux

The initial setup procedure for Linux system is mostly the same with the procedure for Microsoft Windows. Please follow the steps below to setup recovery tool for Linux OS.

Step 1: Hardware and BIOS setup. Refer to **Section C.2.1**.

Step 2: Install Linux operating system. Make sure to install GRUB (v0.97 or earlier) MBR type and Ext3 partition type. Leave enough space on the hard drive to create the recover partition later.



NOTE:

If the Linux OS is not installed with GRUB (v0.97 or earlier) and Ext3, the Symantec Ghost may not function properly.

While installing Linux OS, please create two partitions:

- Partition 1: /
- Partition 2: **SWAP**



NOTE:

Please reserve enough space for partition 3 for saving recovery images.

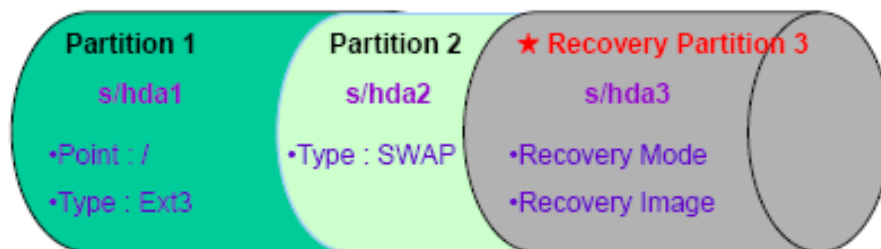

Figure C-29: Partitions for Linux

Step 3: Create a recovery partition. Insert the recovery CD into the optical disk drive.

Follow **Step 1 ~ Step 3** described in **Section C.2.2**. Then type the following commands (marked in red) to create a partition for recovery images.

system32>diskpart

DISKPART>list vol

```

DISKPART>sel disk 0
DISKPART>create part pri size= ____
DISKPART>assign letter=N
DISKPART>exit
system32>format N: /fs:ntfs /q /v:Recovery /y
system32>exit
    
```

Step 4: **Build the recovery partition.** Press any key to boot from the recovery CD. It will take a while to launch the recovery tool. Please be patient. When the recovery tool setup menu appears, type <3> and press <Enter> (**Figure C-30**). The Symantec Ghost window appears and starts configuring the system to build a recovery partition. After completing the system configuration, press any key to reboot the system. Eject the recovery CD.

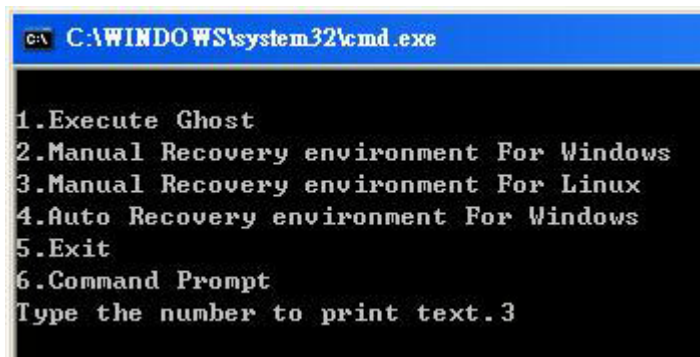

```

C:\WINDOWS\system32\cmd.exe
1.Execute Ghost
2.Manual Recovery environment For Windows
3.Manual Recovery environment For Linux
4.Auto Recovery environment For Windows
5.Exit
6.Command Prompt
Type the number to print text.3
    
```

Figure C-30: Manual Recovery Environment for Linux

Step 5: **Access the recovery tool main menu by modifying the “menu.lst”.** To first access the recovery tool main menu, the menu.lst must be modified. In Linux, enter Administrator (root). When prompt appears, type:

```

cd /boot/grub
vi menu.lst
    
```

```
Fedora release 9 (Sulphur)
Kernel 2.6.25-14.fc9.i686 on an i686 (tty2)

localhost login: root
Password:
[root@localhost ~]# cd /boot/grub/
[root@localhost grub]# vi menu.lst _
```

Figure C-31: Access menu.lst in Linux (Text Mode)

Step 6: Modify the menu.lst as shown below.

```
#boot=/dev/sda
default=0
timeout=10 ← Modify timeout=10
splashimage=(hd0,0)/grub/splash.xpm.gz
hiddenmenu
title Fedora (2.6.25-14.fc9.i686)
    root (hd0,0)
    kernel /vmlinuz-2.6.25-14.fc9.i686 ro root=UUID=10f1acda
    ac38b5c78910 rhgb quiet
    initrd /initrd-2.6.25-14.fc9.i686.img

title Recovery Partition
root (hd0,2) ← Type command
makeactive
chainloader +1
```

- Type command:
title Recovery Partition
root (hd0,2)
makeactive
chainloader +1

Step 7: The recovery tool menu appears. (Figure C-32)

```
1. Factory Restore
2. Backup system
3. Restore your last backup.
4. Manual
5. Quit
Please type the number to select and then press Enter:
```

Figure C-32: Recovery Tool Menu

Step 8: Create a factory default image. Follow Step 2 ~ Step 12 described in Section C.2.5 to create a factory default image.

C.5 Recovery Tool Functions

After completing the initial setup procedures as described above, users can access the recovery tool by pressing <F3> while booting up the system. However, if the setup procedure in Section C.3 has been completed and the auto recovery function is enabled, the system will automatically restore from the factory default image without pressing the F3 key. The recovery tool main menu is shown below.

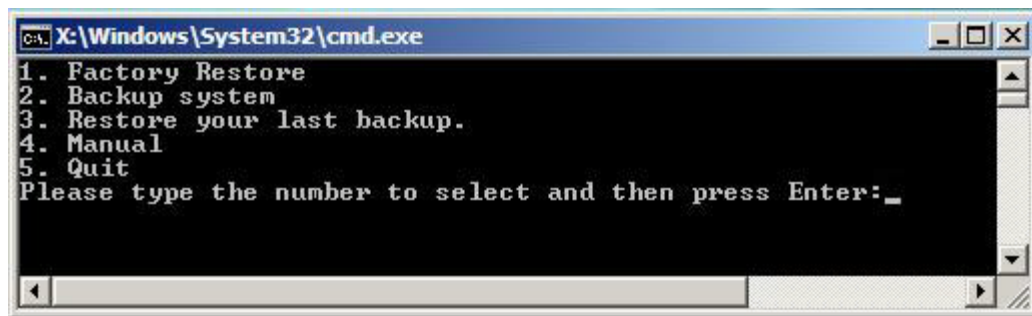

Figure C-33: Recovery Tool Main Menu

The recovery tool has several functions including:

1. **Factory Restore:** Restore the factory default image (iei.GHO) created in Section C.2.5.
2. **Backup system:** Create a system backup image (iei_user.GHO) which will be saved in the hidden partition.
3. **Restore your last backup:** Restore the last system backup image
4. **Manual:** Enter the Symantec Ghost window to configure manually.
5. **Quit:** Exit the recovery tool and restart the system.



WARNING:

Please do not turn off the system power during the process of system recovery or backup.



WARNING:

All data in the system will be deleted during the system recovery. Please backup the system files before restoring the system (either Factory Restore or Restore Backup).

C.5.1 Factory Restore

To restore the factory default image, please follow the steps below.

Step 1: Type <1> and press <Enter> in the main menu.

Step 2: The Symantec Ghost window appears and starts to restore the factory default. A factory default image called **iei.GHO** is created in the hidden Recovery partition.

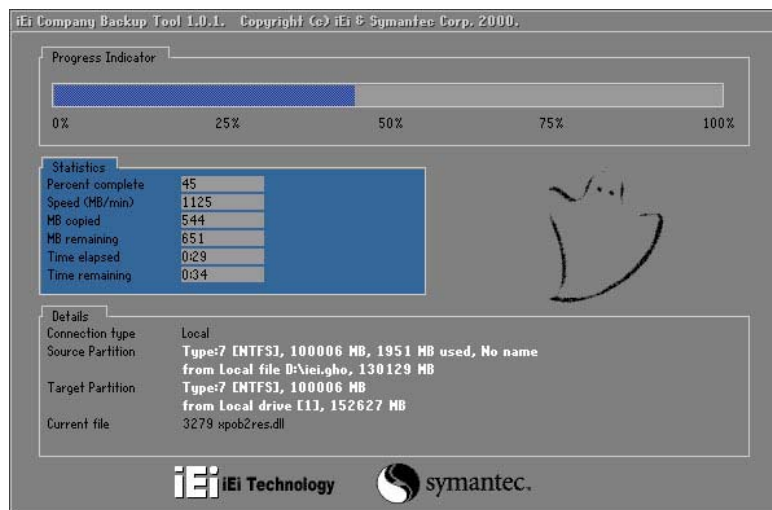

Figure C-34: Restore Factory Default

Step 3: The screen shown in **Figure C-35** appears when completed. Press any key to reboot the system.

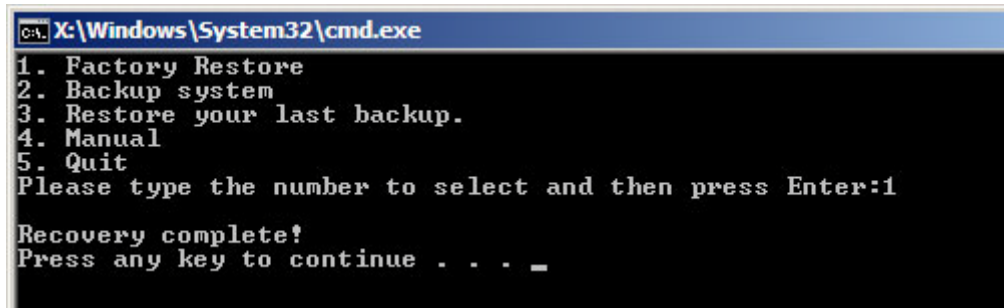

Figure C-35: Recovery Complete Window

C.5.2 Backup System

To backup the system, please follow the steps below.

Step 1: Type <2> and press <Enter> in the main menu.

Step 2: The Symantec Ghost window appears and starts to backup the system. A backup image called `iei_user.GHO` is created in the hidden Recovery partition.

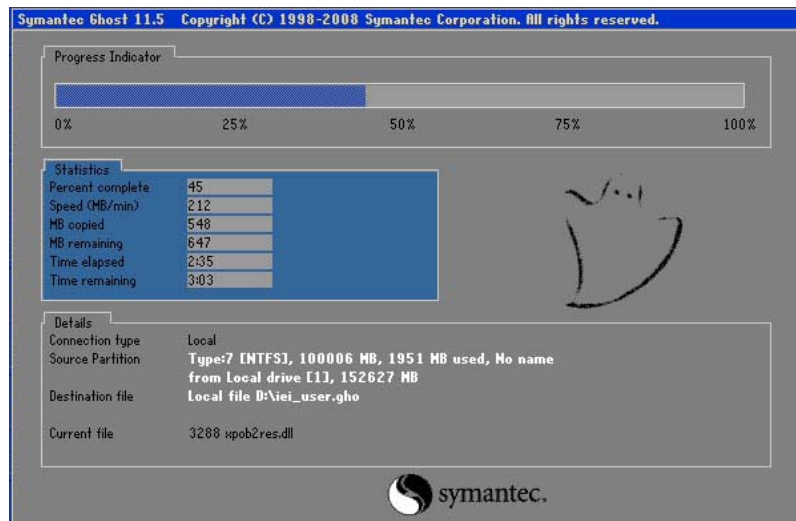

Figure C-36: Backup System

Step 3: The screen shown in **Figure C-37** appears when system backup is complete.

Press any key to reboot the system.

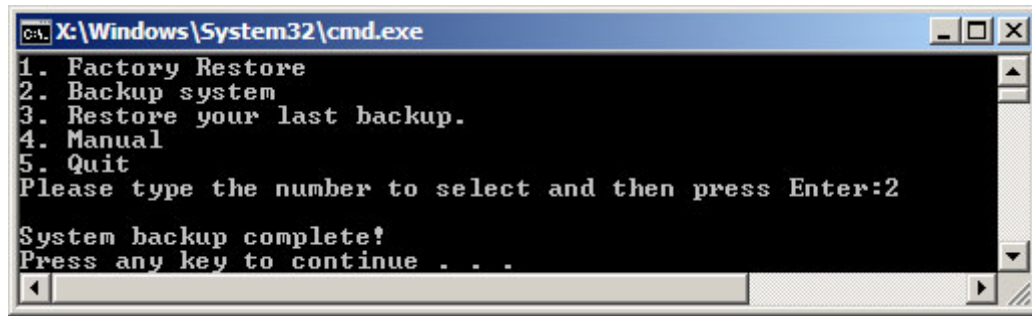

Figure C-37: System Backup Complete Window

C.5.3 Restore Your Last Backup

To restore the last system backup, please follow the steps below.

Step 1: Type <3> and press <Enter> in the main menu.

Step 2: The Symantec Ghost window appears and starts to restore the last backup image (iei_user.GHO).

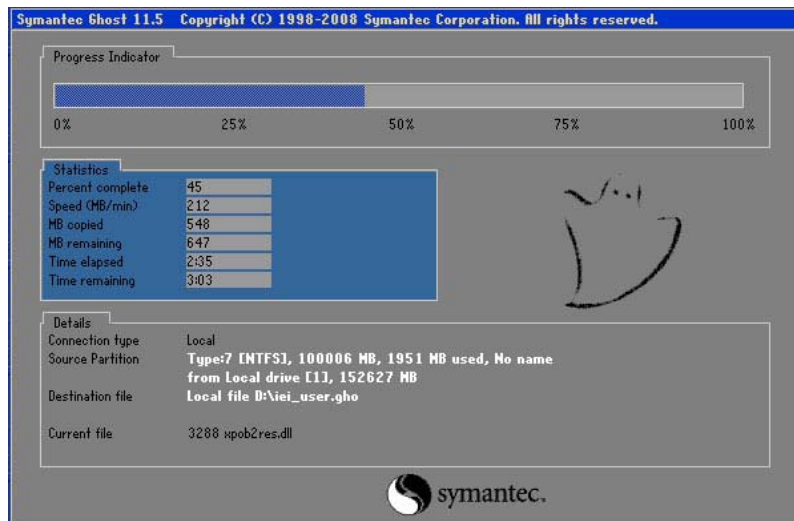

Figure C-38: Restore Backup

Step 3: The screen shown in **Figure C-39** appears when backup recovery is complete. Press any key to reboot the system.

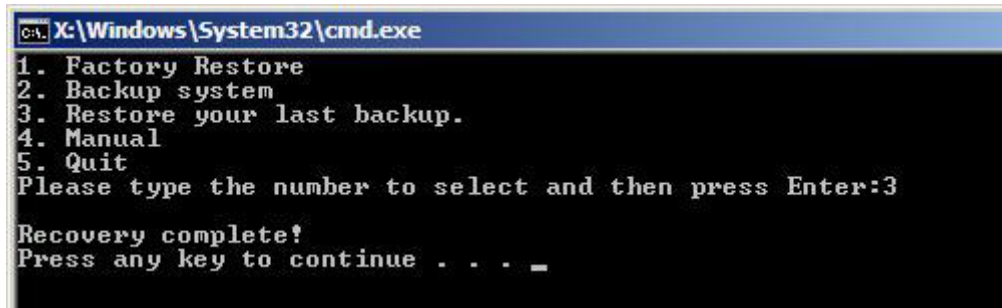

Figure C-39: Restore System Backup Complete Window

C.5.4 Manual

To restore the last system backup, please follow the steps below.

Step 1: Type <4> and press <Enter> in the main menu.

Step 2: The Symantec Ghost window appears. Use the Ghost program to backup or recover the system manually.

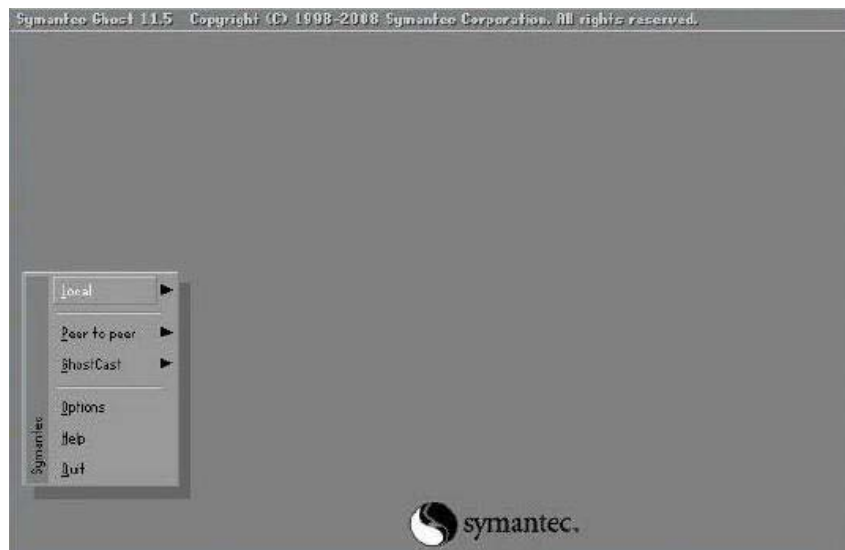
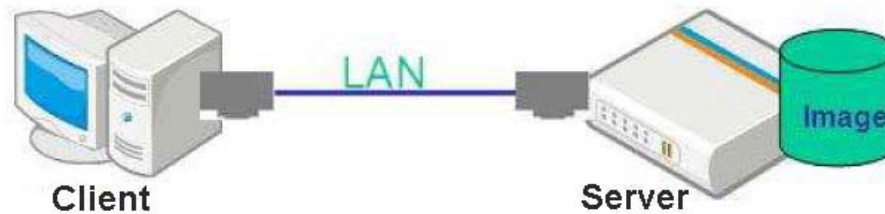

Figure C-40: Symantec Ghost Window

Step 3: When backup or recovery is completed, press any key to reboot the system.

C.6 Restore Systems from a Linux Server through LAN

The One Key Recovery allows a client system to automatically restore to a factory default image saved in a Linux system (the server) through LAN connectivity after encountering a Blue Screen of Death (BSoD) or a hang for around 10 minutes. To be able to use this function, the client system and the Linux system MUST reside in the same domain.



NOTE:

The supported client OS includes:

- Windows 2000
- Windows XP
- Windows Vista
- Windows 7
- Windows CE
- Windows XP Embedded

Prior to restoring client systems from a Linux server, a few setup procedures are required.

Step 1: Configure DHCP server settings

Step 2: Configure TFTP settings

Step 3: Configure One Key Recovery server settings

Step 4: Start DHCP, TFTP and HTTP

Step 5: Create a shared directory

Step 6: Setup a client system for auto recovery

The detailed descriptions are described in the following sections. In this document, two types of Linux OS are used as examples to explain the configuration process – CentOS 5.5 (Kernel 2.6.18) and Debian 5.0.7 (Kernel 2.6.26).

C.6.1 Configure DHCP Server Settings

Step 1: Install the DHCP

`#yum install dhcp` (CentOS, commands marked in red)

`#apt-get install dhcp3-server` (Debian, commands marked in blue)

Step 2: Confirm the operating system default settings: dhcpd.conf.

CentOS

Use the following command to show the DHCP server sample location:

`#vi /etc/dhcpd.conf`

The DHCP server sample location is shown as below:

```
# DHCP Server Configuration file.
# see /usr/share/doc/dhcp*/dhcpd.conf.sample
#
```

Use the following command to copy the DHCP server sample to etc/dhcpd.conf:

`#cp /usr/share/doc/dhcp-3.0.5/dhcpd.conf.sample /etc/dhcpd.conf`

`#vi /etc/dhcpd.conf`

```
ddns-update-style interim;
ignore client-updates;

subnet 192.168.0.0 netmask 255.255.255.0 {
# --- default gateway
    option routers                192.168.0.2;
    option subnet-mask            255.255.255.0;

    option nis-domain             "domain.org";
    option domain-name            "domain.org";
    option domain-name-servers   192.168.0.1;
    next-server 192.168.0.6;
    filename "pxelinux.0";
    option time-offset            -18000; # Eastern Standard Time
    option ntp-servers            192.168.1.1;
}
```

Debian

`#vi /etc/dhcpd.conf`

Edit “/etc/dhcpd.conf” for your environment. For example, add

`next-server PXE server IP address;`

filename "pxelinux.0";

```
ddns-update-style interim;
ignore client-updates;

subnet 192.168.0.0 netmask 255.255.255.0 {
# --- default gateway
option routers                192.168.0.2;
option subnet-mask            255.255.255.0;

option nis-domain              "domain.org";
option domain-name            "domain.org";
option domain-name-servers    192.168.0.1;
next-server 192.168.0.6;
filename "pxelinux.0";
option time-offset             -18000; # Eastern Standard Time
option ntp-servers             192.168.1.1;
}
```

C.6.2 Configure TFTP Settings

Step 1: Install the tftp, httpd and syslinux.

`#yum install tftp-server httpd syslinux` (CentOS)

`#apt-get install tftpd-hpa xinetd syslinux` (Debian)

Step 2: Enable the TFTP server by editing the "/etc/xinetd.d/tftp" file and make it use the remap file. The "-vvv" is optional but it could definitely help on getting more information while running the remap file. For example:

CentOS

`#vi /etc/xinetd.d/tftp`

Modify:

`disable = no`

`server_args = -s /tftpboot -m /tftpboot/tftpd.remap -vvv_`

```
socket_type      = dgram
protocol        = udp
wait            = yes
user            = root
server          = /usr/sbin/in.tftpd
server_args     = -s /tftpboot -m /tftpboot/tftpd.remap -vvv
disable         = no
per_source      = 11
cps             = 100 2
flags           = IPv4
```

Debian

Replace the TFTP settings from “inetd” to “xinetd” and annotate the “inetd” by adding “#”.

`#vi /etc/inetd.conf`

Modify: `#tftp dgram udp wait root /usr/sbin.....` (as shown below)

```
#:BOOT: TFTP service is provided primarily for booting. Most sites
# run this only on machines acting as "boot servers."
#tftp dgram udp wait root /usr/sbin/in.tftpd /usr/sbin/in.tftpd -s
/var/lib/tftpboot
```

`#vi /etc/xinetd.d/tftp`

```
socket_type      = dgram
protocol        = udp
wait            = yes
user            = root
server          = /usr/sbin/in.tftpd
server_args     = -s /tftpboot -m /tftpboot/tftpd.remap -vvv
disable         = no
per_source      = 11
cps             = 100 2
flags           = IPv4
```

C.6.3 Configure One Key Recovery Server Settings

Step 1: Copy the **Utility/RECOVERYR10.TAR.BZ2** package from the One Key Recovery CD to the system (server side).



Step 2: Extract the recovery package to /.

```
#cp RecoveryR10.tar.bz2 /
#cd /
#tar -xvzf RecoveryR10.tar.bz2
```

Step 3: Copy “pxelinux.0” from “syslinux” and install to “tftpboot”.

```
#cp /usr/lib/syslinux/pxelinux.0 /tftpboot/
```

C.6.4 Start the DHCP, TFTP and HTTP

Start the DHCP, TFTP and HTTP. For example:

CentOS

```
#service xinetd restart
```

```
#service httpd restart
```

```
#service dhcpd restart
```

Debian

```
#/etc/init.d/xinetd reload
```

```
#/etc/init.d/xinetd restart
```

```
#/etc/init.d/dhcp3-server restart
```

C.6.5 Create Shared Directory

Step 1: Install the samba.

```
#yum install samba
```

Step 2: Create a shared directory for the factory default image.

```
#mkdir /share
```

```
#cd /share
```

```
#mkdir /image
```

```
#cp iei.gho /image
```



WARNING:

The file name of the factory default image must be **iei.gho**.

Step 3: Confirm the operating system default settings: smb.conf.

```
#vi /etc/samba/smb.conf
```

Modify:

[image]

comment = One Key Recovery

path = /share/image

browseable = yes

writable = yes

public = yes

create mask = 0644

directory mask = 0755

Step 4: Edit "/etc/samba/smb.conf" for your environment. For example:

```
# "security = user" is always a good idea. This will require a Unix account
# in this server for every user accessing the server. See
# /usr/share/doc/samba-doc/htmldocs/Samba3-HOWTO/ServerType.html
# in the samba-doc package for details.
security = share
```

```
[image]
comment = One Key Recovery
path = /share/image
browseable = yes
writable = yes
public = yes
create mask = 0644
directory mask = 0755
```

Step 5: Modify the hostname

#vi /etc/hostname

Modify: RecoveryServer

```
RecoveryServer
```

C.6.6 Setup a Client System for Auto Recovery

Step 1: Configure the following BIOS options of the client system.

Advanced → iEi Feature → Auto Recovery Function → **Enabled**

Advanced → iEi Feature → Recover from PXE → **Enabled**

Boot → Launch PXE OpROM → **Enabled**

ECN-360A-D2550 Embedded System

Step 2: Continue to configure the **Boot Option Priorities** BIOS option of the client system:

Boot Option #1 → remain the default setting to boot from the original OS.

Boot Option #2 → select the boot from LAN option.

Step 3: Save changes and exit BIOS menu.

Exit → **Save Changes and Exit**

Step 4: Install the auto recovery utility into the system by double clicking the **Utility/AUTORECOVERY-SETUP.exe** in the One Key Recovery CD. This utility **MUST** be installed in the system, otherwise, the system will automatically restore from the factory default image every ten (10) minutes.



Step 5: Restart the client system from LAN. If the system encounters a Blue Screen of Death (BSoD) or a hang for around 10 minutes, it will automatically restore from the factory default image. The following screens will show when the system starts auto recovering.

```
Realtek PCIe GBE Family Controller Series v2.35 (06/14/10)
CLIENT MAC ADDR: 00 18 7D 13 E6 89  GUID: 00020003-0004-0005-0006-0007000000
DHCP . ./
```

```
My IP address seems to be C0A80009 192.168.0.9
ip=192.168.0.9:192.168.0.8:192.168.0.2:255.255.255.0
TFTP prefix:
Trying to load: pxelinux.cfg/00020003-0004-0005-0006-000700080009
Trying to load: pxelinux.cfg/01-00-18-7d-13-e6-89
Trying to load: pxelinux.cfg/C0A80009
Trying to load: pxelinux.cfg/C0A8000
Trying to load: pxelinux.cfg/C0A800
Trying to load: pxelinux.cfg/C0A80
Trying to load: pxelinux.cfg/C0A8
Trying to load: pxelinux.cfg/C0A
Trying to load: pxelinux.cfg/C0
Trying to load: pxelinux.cfg/C
Trying to load: pxelinux.cfg/default
boot:
```

Windows is loading files...

IP: 192.168.0.8, File: \Boot\WinPE.wim

Symantec Ghost 11.5 Copyright (C) 1998-2008 Symantec Corporation. All rights reserved.

Progress Indicator



0% 25% 50% 75% 100%

Statistics

Percent complete	52
Speed (MB/min)	468
MB copied	632
MB remaining	563
Time elapsed	1:21
Time remaining	1:12

Details

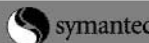
Connection type	Local
Source Partition	Type:7 [NTFS], 100006 MB, 1951 MB used, No name from Local drive [80], 130129 MB
Destination file	Local file D:\iei.GHO
Current file	3891_e_869.nls



NOTE:

A firewall or a SELinux is not in use in the whole setup process. If there is a firewall or a SELinux protecting the system, modify the configuration information to accommodate them.

C.7 Other Information

C.7.1 Using AHCI Mode or ALi M5283 / VIA VT6421A Controller

When the system uses AHCI mode or some specific SATA controllers such as ALi M5283 or VIA VT6421A, the SATA RAID/AHCI driver must be installed before using one key recovery. Please follow the steps below to install the SATA RAID/AHCI driver.

Step 1: Copy the SATA RAID/AHCI driver to a floppy disk and insert the floppy disk into a USB floppy disk drive. The SATA RAID/AHCI driver must be especially designed for the on-board SATA controller.

Step 2: Connect the USB floppy disk drive to the system.

Step 3: Insert the One Key Recovery CD into the system and boot the system from the CD.

Step 4: When launching the recovery tool, press <F6>.

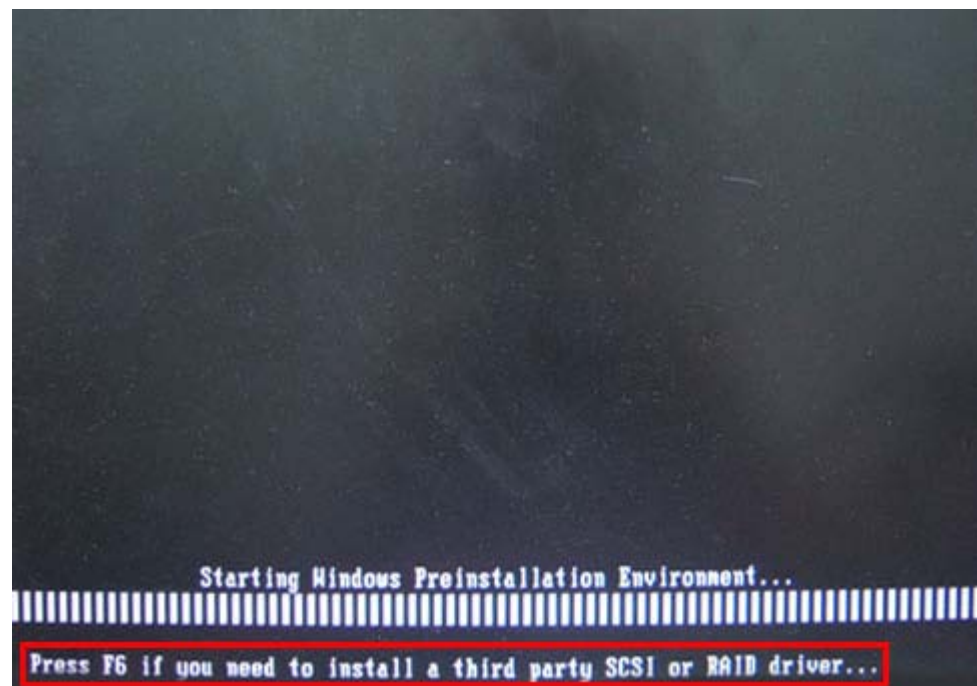

Step 5: When the following window appears, press <S> to select “Specify Additional Device”.

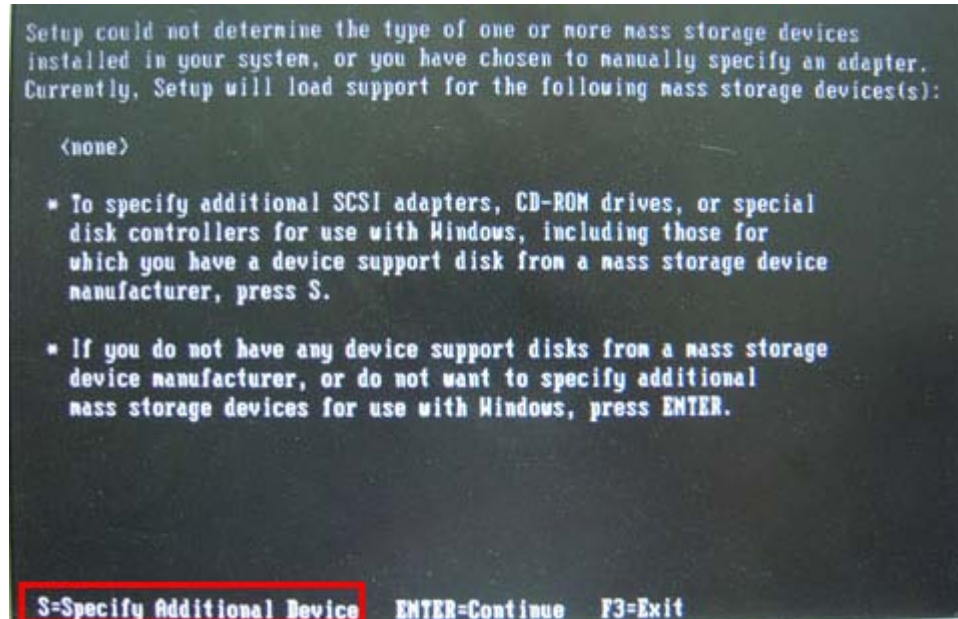

Step 6: In the following window, select a SATA controller mode used in the system. Then press <Enter>. The user can now start using the SATA HDD.

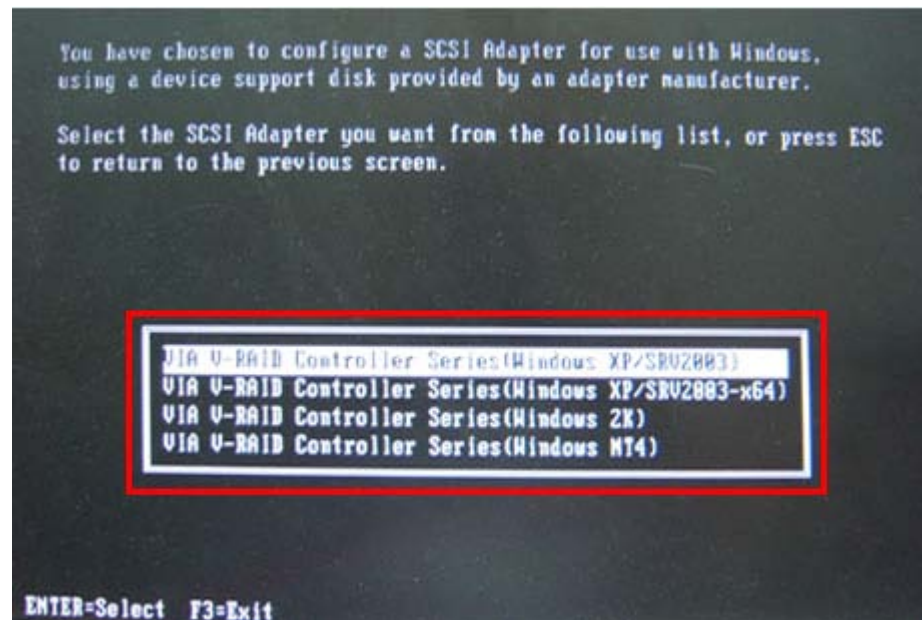

- Step 7:** After pressing <Enter>, the system will get into the recovery tool setup menu. Continue to follow the setup procedure from **Step 4** in **Section C.2.2 Create Partitions** to finish the whole setup process.

C.7.2 System Memory Requirement

To be able to access the recovery tool by pressing <F3> while booting up the system, please make sure to have enough system memory. The minimum memory requirement is listed below.

- **Using Award BIOS:** 128 MB system memory
- **Using AMI BIOS:** 512 MB system memory.

Appendix

D

Watchdog Timer

**NOTE:**

The following discussion applies to DOS environment. IEI support is contacted or the IEI website visited for specific drivers for more sophisticated operating systems, e.g., Windows and Linux.

The Watchdog Timer is provided to ensure that standalone systems can always recover from catastrophic conditions that cause the CPU to crash. This condition may have occurred by external EMI or a software bug. When the CPU stops working correctly, Watchdog Timer either performs a hardware reset (cold boot) or a Non-Maskable Interrupt (NMI) to bring the system back to a known state.

A BIOS function call (INT 15H) is used to control the Watchdog Timer:

INT 15H:

AH – 6FH Sub-function:	
AL – 2:	Sets the Watchdog Timer's period.
BL:	Time-out value (Its unit-second is dependent on the item "Watchdog Timer unit select" in CMOS setup).

Table D-1: AH-6FH Sub-function

Call sub-function 2 to set the time-out period of Watchdog Timer first. If the time-out value is not zero, the Watchdog Timer starts counting down. While the timer value reaches zero, the system resets. To ensure that this reset condition does not occur, calling sub-function 2 must periodically refresh the Watchdog Timer. However, the Watchdog timer is disabled if the time-out value is set to zero.

A tolerance of at least 10% must be maintained to avoid unknown routines within the operating system (DOS), such as disk I/O that can be very time-consuming.

**NOTE:**

When exiting a program it is necessary to disable the Watchdog Timer, otherwise the system resets.

Example program:

```
; INITIAL TIMER PERIOD COUNTER
```

```
;
```

```
W_LOOP:
```

```
    MOV    AX, 6F02H    ;setting the time-out value
```

```
    MOV    BL, 05      ;time-out value is 5 seconds
```

```
    INT    15H
```

```
;
```

```
; ADD THE APPLICATION PROGRAM HERE
```

```
;
```

```
    CMP    EXIT_AP, 1    ;is the application over?
```

```
    JNE    W_LOOP      ;No, restart the application
```

```
    MOV    AX, 6F02H    ;disable Watchdog Timer
```

```
    MOV    BL, 0      ;
```

```
    INT    15H
```

```
;
```

```
; EXIT ;
```

Appendix

E

Hazardous Materials Disclosure

E.1 Hazardous Materials Disclosure Table for IPB Products Certified as RoHS Compliant Under 2002/95/EC Without Mercury

The details provided in this appendix are to ensure that the product is compliant with the Peoples Republic of China (China) RoHS standards. The table below acknowledges the presences of small quantities of certain materials in the product, and is applicable to China RoHS only.

A label will be placed on each product to indicate the estimated “Environmentally Friendly Use Period” (EFUP). This is an estimate of the number of years that these substances would “not leak out or undergo abrupt change.” This product may contain replaceable sub-assemblies/components which have a shorter EFUP such as batteries and lamps. These components will be separately marked.

Please refer to the table on the next page.

ECN-360A-D2550 Embedded System

Part Name	Toxic or Hazardous Substances and Elements					
	Lead (Pb)	Mercury (Hg)	Cadmium (Cd)	Hexavalent Chromium (CR(VI))	Polybrominated Biphenyls (PBB)	Polybrominated Diphenyl Ethers (PBDE)
Housing	X	O	O	O	O	X
Display	X	O	O	O	O	X
Printed Circuit Board	X	O	O	O	O	X
Metal Fasteners	X	O	O	O	O	O
Cable Assembly	X	O	O	O	O	X
Fan Assembly	X	O	O	O	O	X
Power Supply Assemblies	X	O	O	O	O	X
Battery	O	O	O	O	O	O

O: This toxic or hazardous substance is contained in all of the homogeneous materials for the part is below the limit requirement in SJ/T11363-2006

X: This toxic or hazardous substance is contained in at least one of the homogeneous materials for this part is above the limit requirement in SJ/T11363-2006

此附件旨在确保本产品符合中国 RoHS 标准。以下表格标示此产品中某有毒物质的含量符合中国 RoHS 标准规定的限量要求。

本产品上会附有“环境友好使用期限”的标签，此期限是估算这些物质“不会有泄漏或突变”的年限。本产品可能包含有较短的环境友好使用期限的可替换元件，像是电池或灯管，这些元件将会单独标示出来。

部件名称	有毒有害物质或元素					
	铅 (Pb)	汞 (Hg)	镉 (Cd)	六价铬 (CR(VI))	多溴联苯 (PBB)	多溴二苯 醚 (PBDE)
壳体	X	O	O	O	O	X
显示	X	O	O	O	O	X
印刷电路板	X	O	O	O	O	X
金属螺帽	X	O	O	O	O	O
电缆组装	X	O	O	O	O	X
风扇组装	X	O	O	O	O	X
电力供应组装	X	O	O	O	O	X
电池	O	O	O	O	O	O

O: 表示该有毒有害物质在该部件所有物质材料中的含量均在 SJ/T11363-2006 标准规定的限量要求以下。
 X: 表示该有毒有害物质至少在该部件的某一均质材料中的含量超出 SJ/T11363-2006 标准规定的限量要求。