

# AFL4-W07-EHL

## IEI Light Industrial Panel PC

Powered by Intel® Elkhart Lake Platform



[WWW.IEIWORLD.COM](http://WWW.IEIWORLD.COM)



# AFL4-W07-EHL

Fanless panel PC with narrow bezel design, Intel® Celeron® J6412 processor, on-board 8GB memory, HDMI output, 2.5GbE LAN, two UART, three USB, one M.2 M key expansion slot, and anti-glare & anti-UV 10-point touchscreen



## Intel® Celeron® J6412 SoC

Intel® Elkhart Lake low power SoC, adopting 10nm process, 4-core 4-thread, 2.00GHz base frequency and up to 2.60GHz burst frequency.

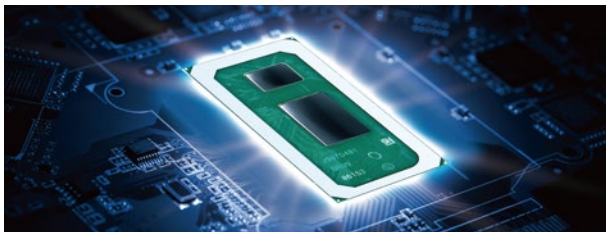

## Support 4K UHD Display Output

10th generation Intel® Ultra HD graphics engine allows the system to display video and images in stunning 4K resolution over HDMI 1.4b

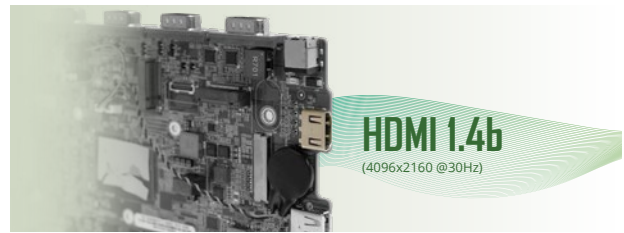

## Anti-glare and Anti-UV PCAP

With anti-glare and anti-UV coating, the 10-point touchscreen can display clearly without reflection for a long time use in outdoors and bright light environment.

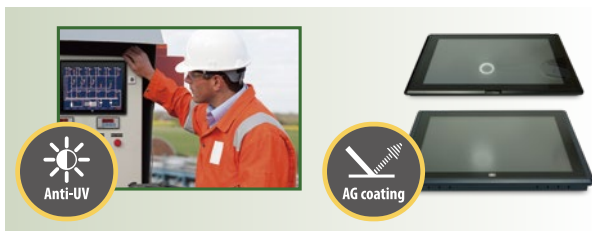

## Works with Gloves and Water

The equipped capacitive touch screen supports gloved operation and waterproof function that can effectively eliminate false touch operating caused by water spray.

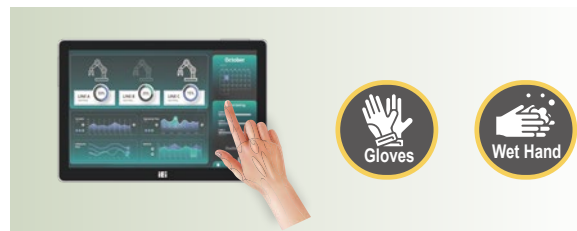

## Extensive I/O Interfaces

The panel PC is small, but comes with abundant I/O for a variety of application scenarios. It includes two UART, three USB, one 2.5G network port and one HDMI interface.



## Support WiFi 6E and Bluetooth 5.2

Strong Wi-Fi 6E wireless network capability provides more bandwidth, and the low latency Bluetooth 5.2 connection is more stable and consumes less power.



# AFL4-W07-EHL I/O

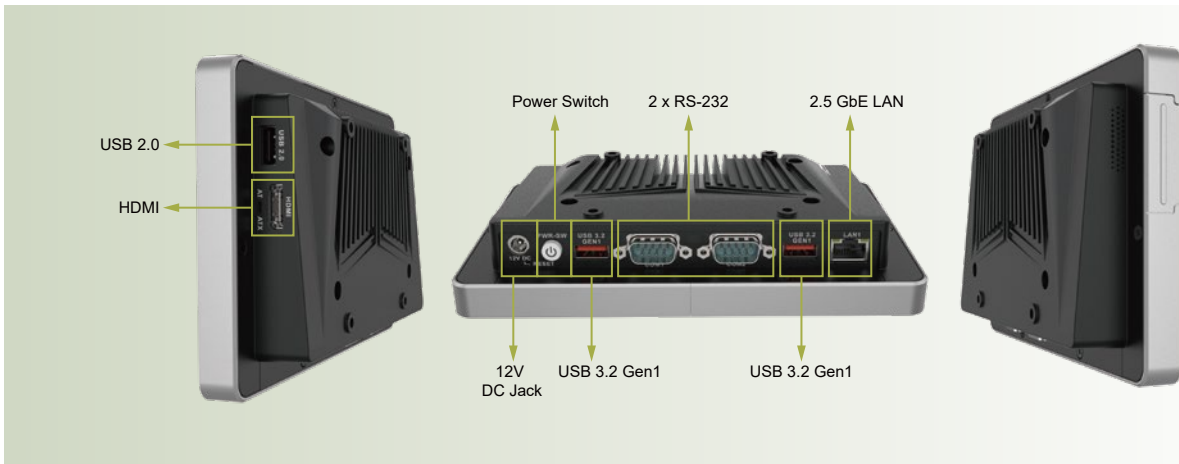

## AFL4-W07-EHL Block Diagram

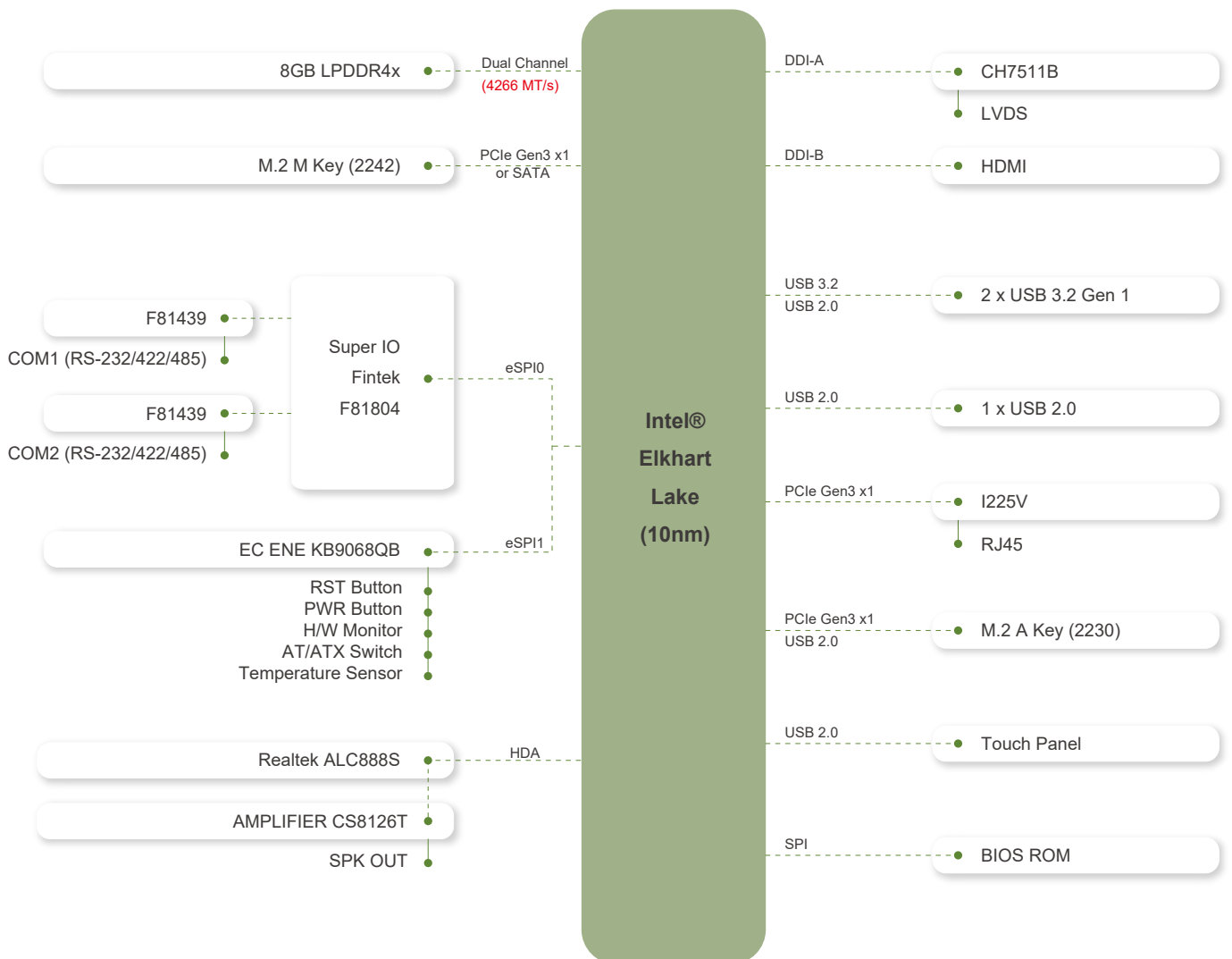

## Dimensions

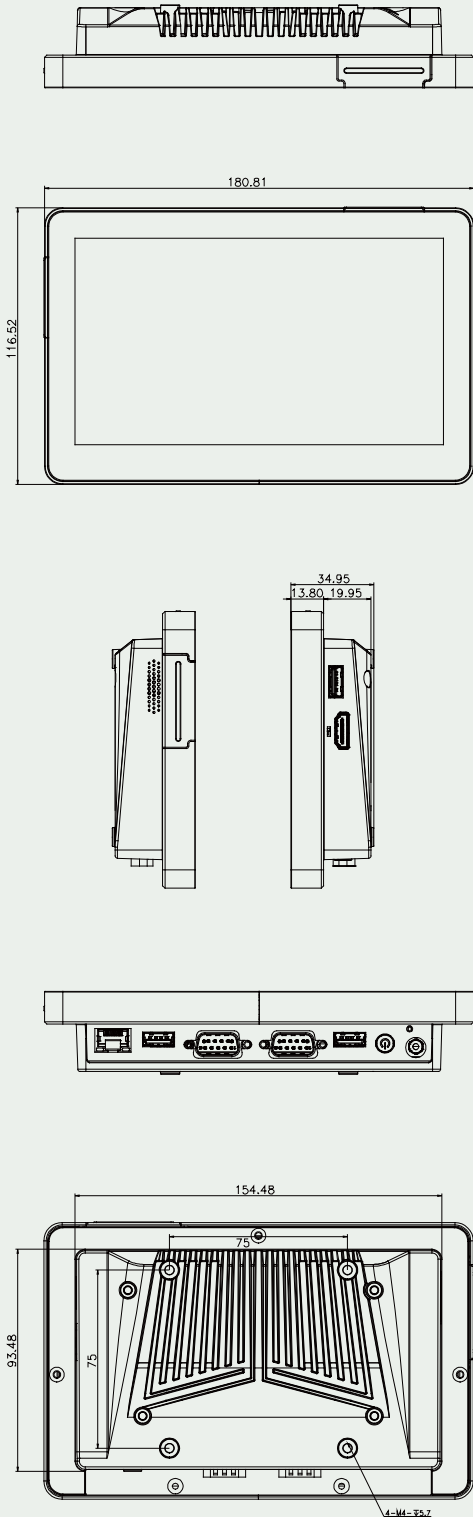

## Specifications

Model	AFL4-W07-EHL	
LCD	LCD Size	7" (16:9)
	Resolution (WxH)	1024 x 600
	Brightness (cd/m <sup>2</sup> )	450
	LCD Color	16.2M
	Pixel Pitch (mm)	0.1506 x 0.1432
	Contrast Ratio	800:1
	Viewing Angle (H-V)	170°/170°
Touch Panel	Backlight MTBF	20000 hours
	Touch Screen	PCAP with USB interface (Anti-UV/AG coating)
Motherboard	Touch IC	EETI EXC 81 Series
	SoC	Intel® Celeron® Processor J6412 1.5M Cache, up to 2.60 GHz / TDP 10W
	RAM	Dual channel 8GB LPDDR4x on board
	Ethernet	LAN1: Intel® I225V 2.5GbE controller
	Audio Codec	Realtek ALC888S
	Storage	128G eMMC (optional)
	Expansion	1 x M.2 M key 2242 (PCIe Gen3 x1 or SATA)
	I/O Port & Switch	2 x RS-232/422/485 by DB9 1 x 2.5GbE LAN 2 x USB 3.2 Gen1 1 x USB 2.0 1 x HDMI output 1 x 12V DC jack 1 x Power button 1 x Reset button 1 x AT/ATX switch
	Speaker	AMP 1.2W (internal speaker)
	Wireless & Bluetooth	IEEE 802.11ax 2T2R module (Wi-Fi 6E) with BT v5.2 (M.2 2230 A Key)
Physical	Body Material	Aluminum die casting
	Mounting	Wall, Stand, Arm, VESA 75
	Color	Silver+Black
Environment	Operating Temperature (°C)	-10 ~ 40
	Storage Temperature (°C)	-20 ~ 60
	Humidity	10% to 95%@40°C (non-condensing)
	Safety & EMC	CE/EMC, UKCA, FCC, RED (Class A)
	Thermal Solution	Fanless
	Power Input	12V DC
	IP level	Front Panel Compliance IP64
	Net weight	0.740 kg
ErP	ErP 2009/125/EC	
OS	Windows 10/11 IoT / Linux	

## Packing List

1 x Power Cord	1 x Power Adapter	1 x QIG
----------------	-------------------	---------

## Ordering Information

AFL4-W07-EHL-J1 /8G-R10	7" 450cd/m <sup>2</sup> 1024x600 fanless panel PC with Intel® Celeron® J6412 (10W) on-board processor, 8GB LPDDR4x on-board, Wi-Fi 6E and Bluetooth 5.2 module, PCAP touch, R10
-------------------------	---

## Options

Item	Part No	Description
Arm	ARM-11-RS	VESA 75/100 Desk Arm
Stand	STAND-C12-R10	VESA 75/100 Easy Stand
V-Stand	VSTAND-A07-R11	Stand V Type for AFL series, VESA 75
Wall	AFLWK-12	Monitor Wall Mount Kit
OS	AFL4-W07-EHL-W10IoT21-E-R10	Win10 IoT Ent LTSC 2021 MultiLang OEI Entry