



MODEL:
TANK-620-ULT3

Embedded System with Intel® Celeron® 3855U processor,
on-board DDR4 4GB Pre-installed Memory, VGA,
Two Gigabit Ethernet, RS-232/422/485,
RoHS Compliant

User Manual

Revision

Date	Version	Changes
December 26, 2018	1.00	Initial release

Copyright

COPYRIGHT NOTICE

The information in this document is subject to change without prior notice in order to improve reliability, design and function and does not represent a commitment on the part of the manufacturer.

In no event will the manufacturer be liable for direct, indirect, special, incidental, or consequential damages arising out of the use or inability to use the product or documentation, even if advised of the possibility of such damages.

This document contains proprietary information protected by copyright. All rights are reserved. No part of this manual may be reproduced by any mechanical, electronic, or other means in any form without prior written permission of the manufacturer.

TRADEMARKS

All registered trademarks and product names mentioned herein are used for identification purposes only and may be trademarks and/or registered trademarks of their respective owners.

Manual Conventions

**WARNING**

Warnings appear where overlooked details may cause damage to the equipment or result in personal injury. Warnings should be taken seriously.

**CAUTION**

Cautionary messages should be heeded to help reduce the chance of losing data or damaging the product.

**NOTE**

These messages inform the reader of essential but non-critical information. These messages should be read carefully as any directions or instructions contained therein can help avoid making mistakes.

**HOT SURFACE**

This symbol indicates a hot surface that should not be touched without taking care.

Table of Contents

1 INTRODUCTION	1
1.1 OVERVIEW.....	2
1.2 FEATURES.....	2
1.3 TECHNICAL SPECIFICATIONS.....	3
1.4 FRONT PANEL.....	5
1.5 REAR PANEL.....	5
1.6 PHYSICAL DIMENSIONS.....	7
2 UNPACKING	8
2.1 ANTI-STATIC PRECAUTIONS.....	9
2.2 UNPACKING PRECAUTIONS.....	9
2.3 UNPACKING CHECKLIST.....	10
3 INSTALLATION	12
3.1 INSTALLATION PRECAUTIONS.....	13
3.2 HARD DISK DRIVE (HDD) INSTALLATION.....	13
3.3 MOUNTING THE SYSTEM WITH MOUNTING BRACKETS.....	15
3.4 EXTERNAL PERIPHERAL INTERFACE CONNECTORS.....	16
3.4.1 AT/ATX Power Mode Selection.....	16
3.4.2 Audio Connector.....	16
3.4.3 Digital Input/Output Connector.....	17
3.4.4 LAN Connectors.....	17
3.4.5 Power Input, 3-pin Terminal Block.....	19
3.4.6 Serial Port Connectors.....	19
3.4.7 USB Connectors.....	20
3.4.8 VGA Connector.....	21
3.5 POWERING ON/OFF THE SYSTEM.....	22
4 SYSTEM MOTHERBOARD	23
4.1 OVERVIEW.....	24
4.1.1 Layout.....	24

4.2 INTERNAL PERIPHERAL CONNECTORS	25
4.2.1 Battery Connector (BAT1)	25
4.2.2 BIOS Programming Connector (JSP11)	26
4.2.3 CPU Fan Connector (CPU/FAN1)	26
4.2.4 LPT Connector (LPT1)	26
4.2.5 EC Debug Connector (CN1).....	27
4.2.6 EC Programming Connector (JSPI2).....	27
4.2.7 Keyboard and mouse connector (KB_MS_CN1).....	27
4.2.8 SATA Power Connectors (SATA_PWR1, SATA_PWR2).....	28
4.2.9 TPM Connector (TPM1).....	28
4.3 EXTERNAL INTERFACE PANEL CONNECTORS	29
4.3.1 Audio Jack (A_JACK1).....	29
4.3.2 DIO connector (DIO1).....	30
4.3.3 Ethernet and USB 3.0 Connectors (LAN1_USB1).....	30
4.3.4 Ethernet and USB 3.0 Connectors (LAN2_USB2).....	31
4.3.5 Power Connector (PWR2)	32
4.3.6 RS-232 Serial Port Connectors (COM1~ COM6).....	32
4.3.7 RS-232/422/485 Serial Port Connector (COM7~COM14)	32
4.3.8 USB 2.0 Connectors (USB1).....	33
4.3.9 VGA Connectors (VGA1_2).....	33
4.4 JUMPER SETTINGS	34
4.4.1 AT/ATX Mode Select Switch (J_ATX_AT1).....	34
4.4.2 Clear CMOS Button (J_CMOS1).....	34
4.4.3 System Reset Button (RST1).....	35
5 BIOS	36
5.1 INTRODUCTION	37
5.1.1 Starting Setup.....	37
5.1.2 Using Setup	37
5.1.3 Getting Help.....	38
5.1.4 Unable to Reboot after Configuration Changes	38
5.1.5 BIOS Menu Bar.....	38
5.2 MAIN	40
5.3 ADVANCED	41
5.3.1 Trusted Computing.....	42

TANK-620-ULT3 Embedded System

5.3.2 ACPI Settings	43
5.3.3 F81866 Super IO Configuration	44
5.3.3.1 Serial Port n Configuration	44
5.3.3.2 Parallel Port Configuration.....	48
5.3.4 Hardware Monitor	50
5.3.4.1 Smart Fan Mode Configuration.....	51
5.3.5 F81866SEC Super IO Configuration	52
5.3.5.1 Serial Port n Configuration	53
5.3.6 IT8528TRD Super IO Configuration.....	58
5.3.6.1 Serial Port n Configuration	58
5.3.7 RTC Wake Settings	59
5.3.8 Serial Port Console Redirection	61
5.3.8.1 Console Redirection Settings	62
5.3.9 CPU Configuration.....	64
5.3.10 SATA Configuration	67
5.3.11 USB Configuration.....	68
5.3.12 iEi Feature.....	69
5.4 CHIPSET.....	70
5.4.1 System Agent (SA) Configuration	71
5.4.1.1 Graphics Configuration.....	71
5.4.1.2 Memory Configuration.....	75
5.4.2 PCH-IO Configuration	76
5.4.2.1 HD Audio Configuration.....	77
5.5 SECURITY.....	78
5.6 BOOT.....	79
5.7 SAVE & EXIT	81
A REGULATORY COMPLIANCE	83
B BIOS OPTIONS	88
C TERMINOLOGY.....	92
D SAFETY PRECAUTIONS.....	96
D.1 SAFETY PRECAUTIONS	97
D.1.1 General Safety Precautions.....	97
D.1.2 Anti-static Precautions.....	98

<i>D.1.3 Product Disposal</i>	99
<i>D.2 MAINTENANCE AND CLEANING PRECAUTIONS</i>	99
<i>D.2.1 Maintenance and Cleaning</i>	100
<i>D.2.2 Cleaning Tools</i>	100
<i>E DIGITAL I/O INTERFACE</i>	101
<i>E.1 INTRODUCTION</i>	102
<i>E.2 ASSEMBLY LANGUAGE SAMPLE 1</i>	103
<i>E.3 ASSEMBLY LANGUAGE SAMPLE 2</i>	103
<i>F HAZARDOUS MATERIALS DISCLOSURE</i>	104

List of Figures

Figure 1-1: TANK-620-ULT3	2
Figure 1-2: TANK-620-ULT3 Front Panel	5
Figure 1-3: TANK-620-ULT3 Rear Panel	5
Figure 1-4: TANK-870AI slot Physical Dimensions (millimeters)	7
Figure 3-1: HDD Panel Retention Screws	14
Figure 3-2: HDD Bracket Retention Screws	14
Figure 3-3: HDD Installation	14
Figure 3-4: Mounting Bracket Retention Screws	15
Figure 3-5: AT/ATX Power Mode Switch	16
Figure 3-6: Audio Connector	17
Figure 3-7: DIO Connector	17
Figure 3-8: LAN Connection	18
Figure 3-9: RJ-45 Ethernet Connector	18
Figure 3-10: 3-pin Terminal Block	19
Figure 3-11: Serial Device Connector	19
Figure 3-12: DB-9 RS-232/422/485 Serial Port Connector	20
Figure 3-13: USB Device Connection	20
Figure 3-14: VGA Connector	21
Figure 3-15: VGA Connector	22
Figure 3-16: Power Button	22
Figure 4-1: System Motherboard (Front)	24
Figure 4-2: System Motherboard (Rear)	24
Figure 4-3: External Peripheral Interface Connector	29

List of Tables

Table 1-1: Technical Specifications.....	4
Table 3-1: RJ-45 Ethernet Connector LEDs	18
Table 4-1: Peripheral Interface Connectors	25
Table 4-2: Battery Connector Pinouts (BAT1)	25
Table 4-3: BIOS Programming Connector Pinouts (JSPI1).....	26
Table 4-4: CPU Fan Connector Pinouts (CPU/FAN1).....	26
Table 4-5: LPT connector Pinouts (LPT1)	26
Table 4-6: EC Debug Connector Pinouts (CN1).....	27
Table 4-7: EC Programming Connector Pinouts (JSPI2).....	27
Table 4-8: Keyboard and mouse connector Pinouts (KB_MS_CN1).....	27
Table 4-9: SATA Power Connectors Pinouts (SATA_PWR1, SATA_PWR2).....	28
Table 4-10: TPM Connector Pinouts (TPM1).....	28
Table 4-11: Rear Panel Connectors	29
Table 4-12: Audio Jack Pinouts (A_JACK1)	30
Table 4-13: DIO connector Pinouts (DIO1).....	30
Table 4-14: Ethernet and USB 2.0 Connectors (LAN1_USB1)	31
Table 4-15: Ethernet and USB 2.0 Connectors (LAN2_USB2)	32
Table 4-16: Power Connector Pinouts (PWR2).....	32
Table 4-17: RS-232 Serial Port Connectors Pinouts (COM1~COM6).....	32
Table 4-18: RS-232/422/485 Serial Port Connector Pinout (COM7~COM14).....	33
Table 4-19: USB 2.0 Connectors Pinouts (USB1).....	33
Table 4-20: VGA Connectors Pinouts (VGA_21)	34
Table 4-21: Buttons, Jumper and Switch	34
Table 4-22: AT/ATX Mode Select Switch (J_ATX_AT1).....	34
Table 4-23: Clear CMOS Button (J_CMOS1).....	34
Table 4-24: System Reset Button (RST1).....	35
Table 5-1: BIOS Navigation Keys	38

BIOS Menus

BIOS Menu 1: Main	40
BIOS Menu 2: Advanced	42
BIOS Menu 3: Trusted Computing	42
BIOS Menu 4: ACPI Configuration	43
BIOS Menu 5: F81866 Super IO Configuration	44
BIOS Menu 6: Serial Port n Configuration Menu	44
BIOS Menu 7: Parallel Port Configuration Menu	48
BIOS Menu 8: F81866 H/W Monitor	50
BIOS Menu 9: Smart Fan Mode Configuration	51
BIOS Menu 10: F81866 Super IO Configuration	52
BIOS Menu 11: Serial Port n Configuration Menu	53
BIOS Menu 12: F81866 Super IO Configuration	58
BIOS Menu 13: Serial Port n Configuration Menu	58
BIOS Menu 14: RTC Wake Settings	60
BIOS Menu 15: Serial Port Console Redirection	61
BIOS Menu 16: Console Redirection Settings	62
BIOS Menu 17: CPU Configuration	65
BIOS Menu 18: SATA Configuration	67
BIOS Menu 19: USB Configuration	68
BIOS Menu 20: iEi Feature	69
BIOS Menu 21: Chipset	70
BIOS Menu 22: System Agent (SA) Configuration	71
BIOS Menu 23: Graphics Configuration	72
BIOS Menu 24: LCD Control	74
BIOS Menu 25: Memory Configuration	75
BIOS Menu 26: PCH-IO Configuration	76
BIOS Menu 27: PCH Azalia Configuration	77
BIOS Menu 28: Security	78
BIOS Menu 29: Boot	79
BIOS Menu 30: Exit	81

Chapter

1

Introduction

1.1 Overview



Figure 1-1: TANK-620-ULT3

The TANK-620-ULT3 is an embedded system for wide range temperature environments. It is powered by the Intel® Celeron® 3855U processor and supports one 260-pin DDR4 SDRAM SO-DIMM modules up to 32 GB (on-board DDR4 4GB memory preinstalled). The TANK-620-ULT3 includes two VGA ports (default), one VGA port (optional), one LVDS port (optional), two GbE LAN ports, four USB 3.0 ports, four USB 2.0 ports, six RS-232 connectors and eight RS-232/422/485 connectors.

1.2 Features

The TANK-620-ULT3 features are listed below:

- Intel® Celeron® 3855U Skylake processor, TDP 15W
- Multiple COM port (up to 14)
- Multiple USB & LAN
- 24-bit DIO control
- DIO & COM port with TX signal LED indicator for data transmission indication
- Easy accessible storage

TANK-620-ULT3 Embedded System

1.3 Technical Specifications

The TANK-620-ULT3 technical specifications are listed in **Table 1-1**.

Specifications	
Chassis	
Color	Black C + Silver
Dimensions (WxHxD) (mm)	260 x 200 x100
System Fan	Fanless
Chassis Construction	Extruded aluminum alloys
Motherboard	
CPU	Intel® Celeron® 3855U 15W Skylake processor
Chipset	SoC
System Memory	1 x 260-pin DDR4 SO-DIMM 1 x on-board DDR4 4GB pre-installed (system max: 32GB)
Storage	
Hard Drive	1 x 2.5" SATA 6Gb/s HDD/SSD Bay
CF	1 x CF card (optional*)
NVRAM	1 Mb FRAM
I/O Interfaces	
USB 3.0	4
USB 2.0	4
Ethernet	2 x RJ-45 PCIe GbE by Intel® I211-AT controller
COM Port	6 x RS-232 (DB-9) 8 x RS-232/422/485 ports with automatic flow control (DB-9)
Digital I/O	1 x 24-bit digital I/O
Display	2 x VGA, (1 x LVDS or 1 x VGA optional)
Resolution	VGA: Up to 1920 x 1200 @60Hz LVDS: Up to 1920 x 1200 @60Hz (optional)

Specifications	
Audio	1 x Mic in, 1 x Speaker out, 1 x Line out
Wireless	1 x 802.11a/b/g/n/ac (optional)
Expansions	
PCIe Mini	2 x Full-size PCIe Mini slot
M.2	1 x M.2 2280 (M key, PCIe by 4, SATA co-lay SATA2)
Power	
Power Input	9 ~ 36 V DC +/- 5%
Power Consumption	TBD
Others	1 x System reset, power button, AT/ATX switch
Reliability	
Mounting	Wall mount
Operating Temperature	-30 ~ 70 °C with air flow (SSD), 10% ~ 95%, non-condensing
Storage Temperature	-40 ~ 85 °C
Operating Shock	Half-sine wave shock 5G, 11ms, 100 shocks per axis
Operating Vibration	MIL-STD-810G 514.6C-1 (with SSD)
Weight (Net/Gross)	TBD
Safety/EMC	CE/FCC
Watchdog Timer	Programmable 1~255 sec/min
Others	
LED	Power LED, HDD LED, COM ports
OS	
Supported OS	Microsoft® Windows 8 Embedded, Microsoft® Windows® Embedded Standard 7 E, Microsoft® Windows® 10

Table 1-1: Technical Specifications

TANK-620-ULT3 Embedded System

1.4 Front Panel

The front panel of the TANK-620-ULT3 has the following features (**Figure 1-2**):

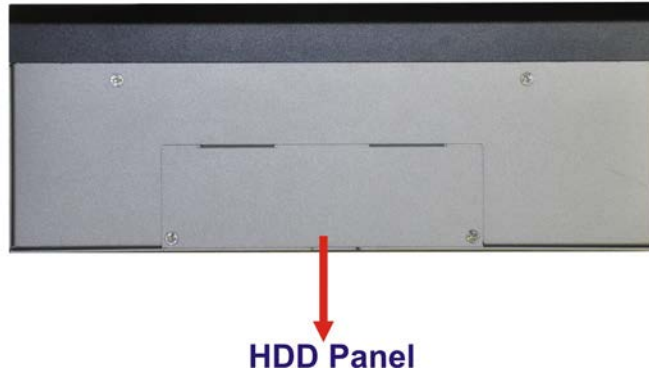

Figure 1-2: TANK-620-ULT3 Front Panel

1.5 Rear Panel

The rear panel of the TANK-620-ULT3 has the following features (**Figure 1-3**):

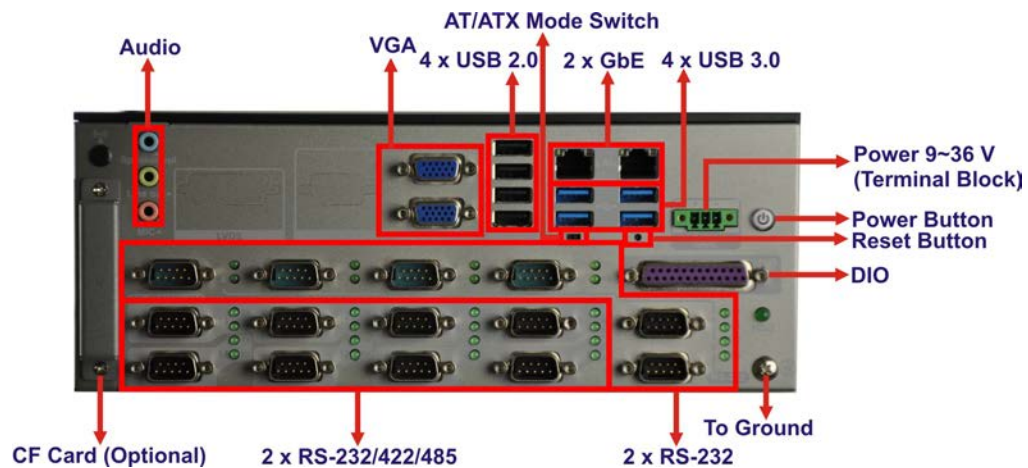

Figure 1-3: TANK-620-ULT3 Rear Panel

Connectors and buttons on the rear panel include the following:

- 1 x AT/ATX mode switch
- 3 x Audio ports (speaker out, line out, Mic-in)
- 1 x CF Card slot (Optional)
- 1 X DIO port

- 2 x Gigabit Ethernet ports (RJ-45)
- 1 x Power button
- 1 x Power terminal block for 9 V ~ 36 V power input
- 1 x Reset button
- 6 x RS-232 serial ports (DB-9)
- 8 x RS-232/422/485 serial ports (DB-9)
- 1 x To Ground
- 4 x USB 3.0 ports
- 4 x USB 2.0 ports
- 2 x VGA ports

TANK-620-ULT3 Embedded System

1.6 Physical Dimensions

The physical dimensions of the TANK-870AI slot are shown in **Figure 1-4**.

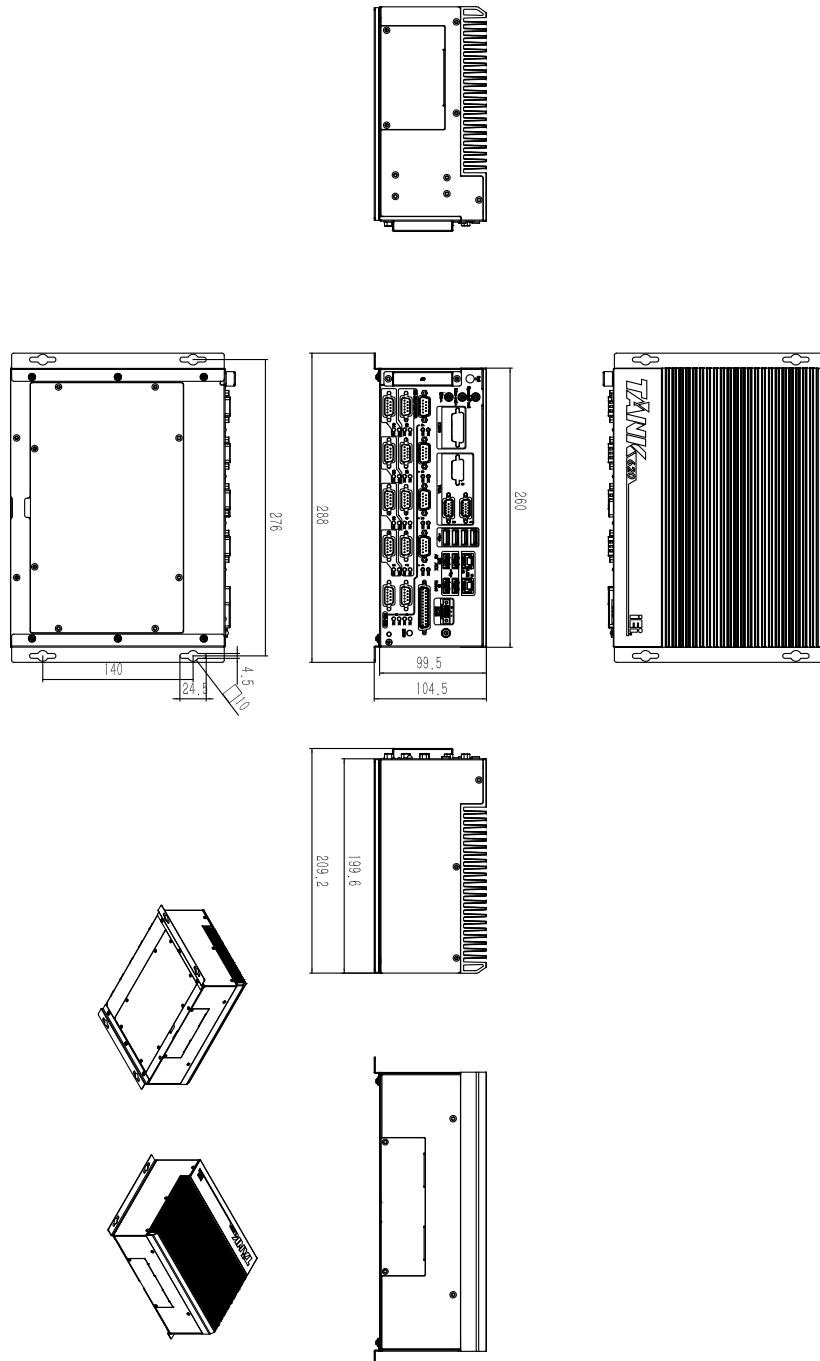

Figure 1-4: TANK-870AI slot Physical Dimensions (millimeters)

Chapter

2

Unpacking

TANK-620-ULT3 Embedded System

2.1 Anti-static Precautions



WARNING:

Failure to take ESD precautions during installation may result in permanent damage to the TANK-620-ULT3 and severe injury to the user.

Electrostatic discharge (ESD) can cause serious damage to electronic components, including the TANK-620-ULT3. Dry climates are especially susceptible to ESD. It is therefore critical that whenever the TANK-620-ULT3 or any other electrical component is handled, the following anti-static precautions are strictly adhered to.

- **Wear an anti-static wristband:** Wearing a simple anti-static wristband can help to prevent ESD from damaging the board.
- **Self-grounding:** Before handling the board touch any grounded conducting material. During the time the board is handled, frequently touch any conducting materials that are connected to the ground.
- **Use an anti-static pad:** When configuring the TANK-620-ULT3, place it on an anti-static pad. This reduces the possibility of ESD damaging the TANK-620-ULT3.

2.2 Unpacking Precautions

When the TANK-620-ULT3 is unpacked, please do the following:

- Follow the anti-static precautions outlined in **Section 2.1**.
- Make sure the packing box is facing upwards so the TANK-620-ULT3 does not fall out of the box.
- Make sure all the components shown in **Section 2.3** are present.



2.3 Unpacking Checklist



NOTE:

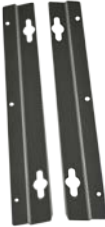

If some of the components listed in the checklist below are missing, please do not proceed with the installation. Contact the IEI reseller or vendor you purchased the TANK-620-ULT3 from or contact an IEI sales representative directly. To contact an IEI sales representative, please send an email to sales@ieiworld.com.

The TANK-620-ULT3 is shipped with the following components:

Quantity	Item and Part Number	Image
Standard		
1	TANK-620-ULT3	
2	Mounting Brackets	
4	Mounting Bracket Screws	
1	Pluggable DC-in Terminal Block	

The following table lists the optional items that can be purchased separately.

TANK-620-ULT3 Embedded System

Optional	
<p>European power cord (P/N: 32702-000400-200-RS)</p>	
<p>Power adapter <i>FSP096-AHAN2; 9NA0961102; Active PFC; Vin:90~64VAC; 96W;</i> <i>Dim:75.6*151.3*25.4mm; plug=6.5mm; cable=1500mm; Erp</i> <i>(noload 15W); Vout: 12VDC; 4-pin DIN w/ lock; CCL; RoHS</i> (P/N: 63040-010096-100-RS)</p>	
<p>1T1R wifi module kit for embedded system, IEEE802.11a/b/g/n/ac WiFi with Bluetooth 4.0/3.0+HS, 1 x wifi module, 2 x 250mm RF cable, 2 x Antenna, RoHS (P/N: EMB-WIFI-KIT01-R20)</p>	
<p>OS image with Windows® Embedded Standard 7E 64-bit for TANK-620-ULT3 series, with DVD-ROM, RoHS (P/N: TANK-620-ULT3-WES7E64-R10)</p>	

Chapter

3

Installation

TANK-620-ULT3 Embedded System

3.1 Installation Precautions

During installation, be aware of the precautions below:

- **Read the user manual:** The user manual provides a complete description of the TANK-620-ULT3, installation instructions and configuration options.
- **DANGER! Disconnect Power:** Power to the TANK-620-ULT3 must be disconnected during the installation process, or before any attempt is made to access the rear panel. Electric shock and personal injury might occur if the rear panel of the TANK-620-ULT3 is opened while the power cord is still connected to an electrical outlet.
- **Qualified Personnel:** The TANK-620-ULT3 must be installed and operated only by trained and qualified personnel. Maintenance, upgrades, or repairs may only be carried out by qualified personnel who are familiar with the associated dangers.
- **Air Circulation:** Make sure there is sufficient air circulation when installing the TANK-620-ULT3. The TANK-620-ULT3's cooling vents must not be obstructed by any objects. Blocking the vents can cause overheating of the TANK-620-ULT3. Leave at least 5 cm of clearance around the TANK-620-ULT3 to prevent overheating.
- **Grounding:** The TANK-620-ULT3 should be properly grounded. The voltage feeds must not be overloaded. Adjust the cabling and provide external overcharge protection per the electrical values indicated on the label attached to the back of the TANK-620-ULT3.

3.2 Hard Disk Drive (HDD) Installation

To install the hard drive, please follow the steps below:

- Step 1:** Remove the HDD panel by removing the two retention screws from the front panel (**Figure 3-1**).

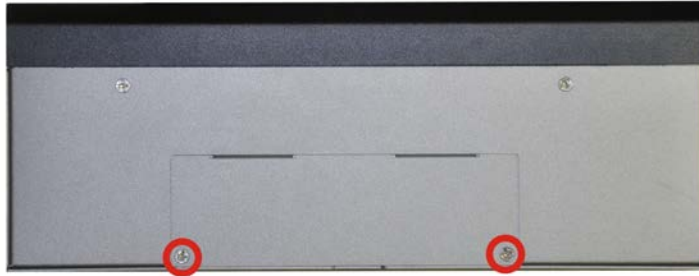

Figure 3-1: HDD Panel Retention Screws

Step 2: Remove the two HDD bracket retention screws (**Figure 3-2**).

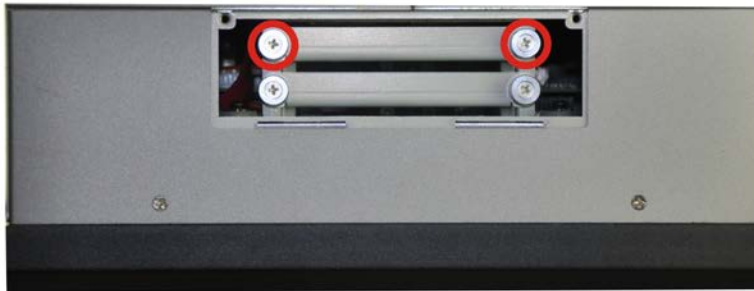

Figure 3-2: HDD Bracket Retention Screws

Step 3: Lift the HDD bracket out of the TANK-620-ULT3 and put it on a flat surface.

Step 4: Attach the HDD to the HDD bracket. Secure the HDD with the HDD bracket by four retention screws (**Figure 3-3**).



Figure 3-3: HDD Installation

TANK-620-ULT3 Embedded System

Step 5: Slide the HDD bracket to connect the HDD to the SATA connector. Secure the HDD bracket with TANK-620-ULT3 by the two retention screws that were previously removed.

Step 6: Reinstall the bottom panel to the TANK-620-ULT3.

3.3 Mounting the System with Mounting Brackets

To mount the embedded system onto a wall or some other surface using the two mounting brackets, please follow the steps below.

Step 1: Turn the embedded system to the left side panel.

Step 2: Align the two retention screw holes in each bracket with the corresponding retention screw holes on the bottom surface (**Figure 3-4**).



Figure 3-4: Mounting Bracket Retention Screws

Step 3: Secure the brackets to the system by inserting two retention screws into each bracket (**Figure 3-4**).

Step 4: Drill holes in the intended installation surface.

Step 5: Align the mounting holes in the sides of the mounting brackets with the predrilled holes in the mounting surface.

Step 6: Insert four retention screws, two in each bracket, to secure the system to the wall.

3.4 External Peripheral Interface Connectors

Detailed descriptions of the connectors can be found in the subsections below.

3.4.1 AT/ATX Power Mode Selection

The TANK-620-ULT3 supports AT and ATX power modes. The setting can be made through the AT/ATX power mode switch on the external peripheral interface panel as shown below.

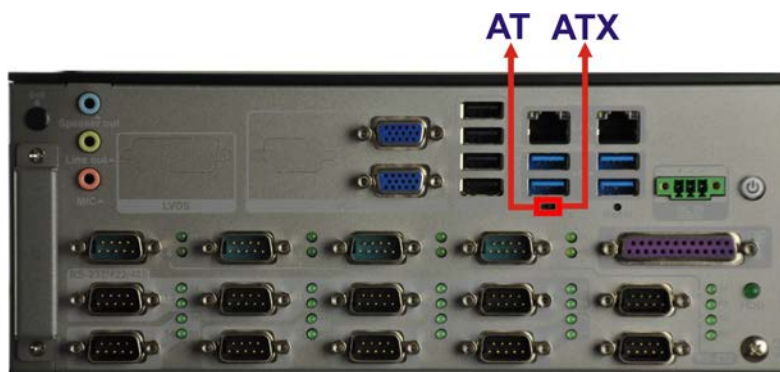

Figure 3-5: AT/ATX Power Mode Switch

3.4.2 Audio Connector

The audio jacks connect to external audio devices.

- **Speaker Out port (Light Blue):** Connects a passive speaker.
- **Line Out port (Lime):** Connects to a headphone or a speaker. With multi-channel configurations, this port can also connect to front speakers.
- **Microphone (Pink):** Connects a microphone.

TANK-620-ULT3 Embedded System



Figure 3-6: Audio Connector

3.4.3 Digital Input/Output Connector

The digital I/O connector provides programmable input and output for external devices. The pinouts for the digital I/O connector are listed in the table below.



Figure 3-7: DIO Connector

3.4.4 LAN Connectors

The LAN connectors allow connection to an external network.

Step 1: Locate the RJ-45 connectors. The locations of the RJ-45 connectors are shown in **Figure 1-3**.

Step 2: Align the connectors. Align the RJ-45 connector on the LAN cable with one of the RJ-45 connectors on the TANK-620-ULT3. See **Figure 3-8**.

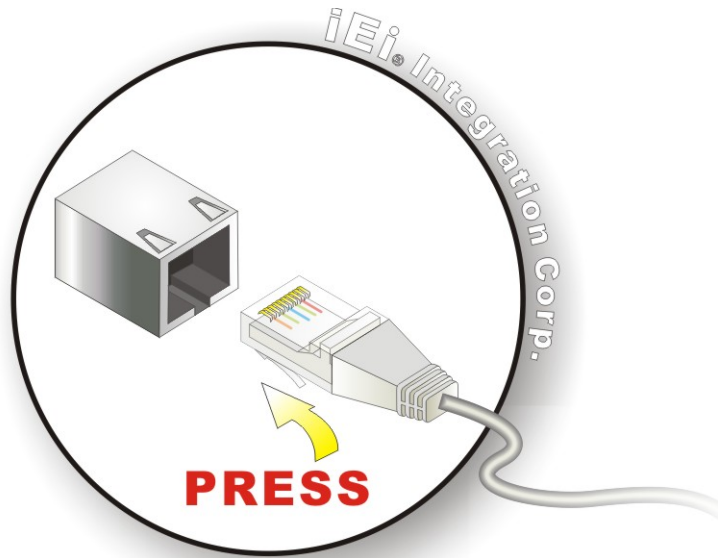

Figure 3-8: LAN Connection

Step 3: Insert the LAN cable RJ-45 connector. Once aligned, gently insert the LAN cable RJ-45 connector into the on-board RJ-45 connector.



Figure 3-9: RJ-45 Ethernet Connector

The RJ-45 Ethernet connector has two status LEDs, one green and one yellow. The green LED indicates activity on the port and the yellow LED indicates the port is linked. See **Table 3-1**.

Activity/Link LED		Speed LED	
STATUS	DESCRIPTION	STATUS	DESCRIPTION
Off	No link	Off	10 Mbps connection
Yellow	Linked	Green	100 Mbps connection
Blinking	TX/RX activity	Orange	1 Gbps connection

Table 3-1: RJ-45 Ethernet Connector LEDs

TANK-620-ULT3 Embedded System

3.4.5 Power Input, 3-pin Terminal Block

The power connector connects the leads of a 9 V~36 V DC power supply into the terminal block. Make sure that the power and ground wires are attached to the correct sockets of the connector.

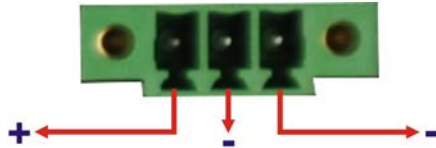

Figure 3-10: 3-pin Terminal Block

3.4.6 Serial Port Connectors

Serial port devices can be attached to the DB-9 ports on the rear panel.

Step 1: Locate the DB-9 connector. The locations of the DB-9 connectors are shown in Figure 1-3.

Step 2: Insert the serial connector. Insert the DB-9 connector of a serial device into the DB-9 connector on the external peripheral interface. See Figure 3-11.

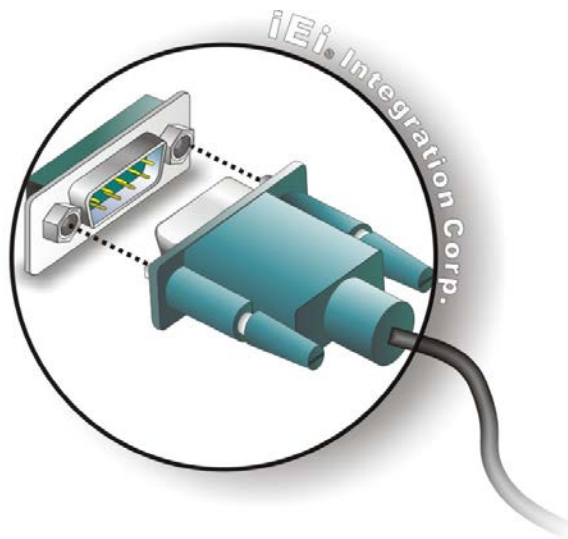

Figure 3-11: Serial Device Connector

Step 3: Secure the connector. Secure the serial device connector to the external interface by tightening the two retention screws on either side of the connector.

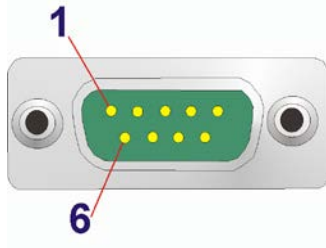

Figure 3-12: DB-9 RS-232/422/485 Serial Port Connector

3.4.7 USB Connectors

The USB ports are for connecting USB peripheral devices to the system.

Step 1: Locate the USB connectors. The locations of the USB connectors are shown in **Figure 1-3**.

Step 2: Align the connectors. Align the USB device connector with one of the connectors. See **Figure 3-13**.

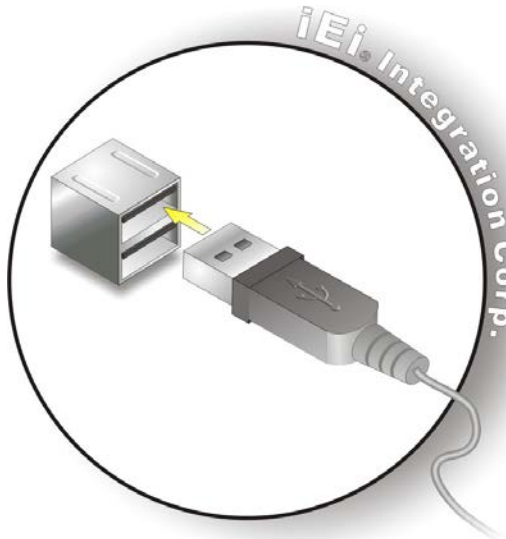

Figure 3-13: USB Device Connection

TANK-620-ULT3 Embedded System

Step 3: **Insert the device connector.** Once aligned, gently insert the USB device connector into the on-board connector.

3.4.8 VGA Connector

The VGA connector connects to a monitor that accepts VGA video input.

Step 1: **Locate the female DB-15 connector.** The location of the female DB-15 connector is shown in **Figure 1-3**.

Step 2: **Align the VGA connector.** Align the male DB-15 connector on the VGA screen cable with the female DB-15 connector on the external peripheral interface.

Step 3: **Insert the VGA connector** Once the connectors are properly aligned with, insert the male connector from the VGA screen into the female connector on the TANK-620-ULT3. See **Figure 3-14**.

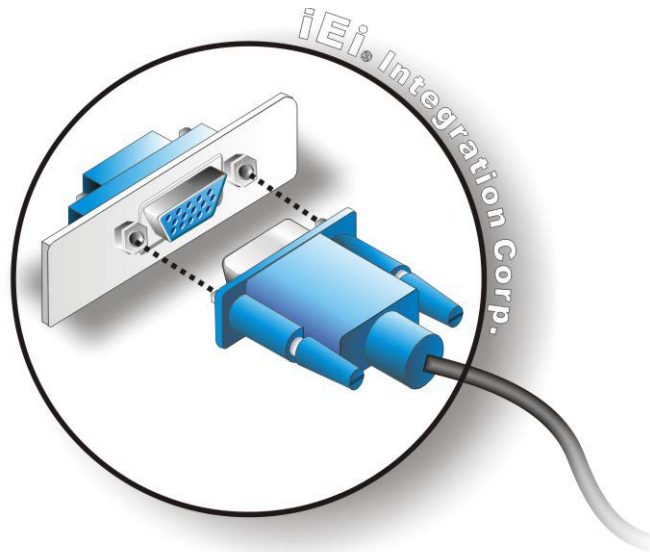

Figure 3-14: VGA Connector

Step 4: **Secure the connector.** Secure the DB-15 VGA connector from the VGA monitor to the external interface by tightening the two retention screws on either side of the connector.

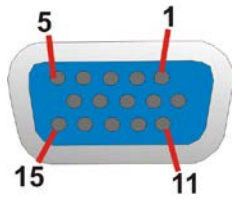

Figure 3-15: VGA Connector

3.5 Powering On/Off the System



WARNING:

Make sure a power supply with the correct input voltage is being fed into the system. Incorrect voltages applied to the system may cause damage to the internal electronic components and may also cause injury to the user.

- **Power on** the system: press the power button for 3 seconds
- **Power off** the system: press the power button for 6 seconds



Figure 3-16: Power Button

Chapter

4

System Motherboard

4.1 Overview

This chapter details all the jumpers and connectors of the system motherboard.

4.1.1 Layout

The figures below show all the connectors and jumpers of the system motherboard. The Pin 1 locations of the on-board connectors are also indicated in the diagram below.

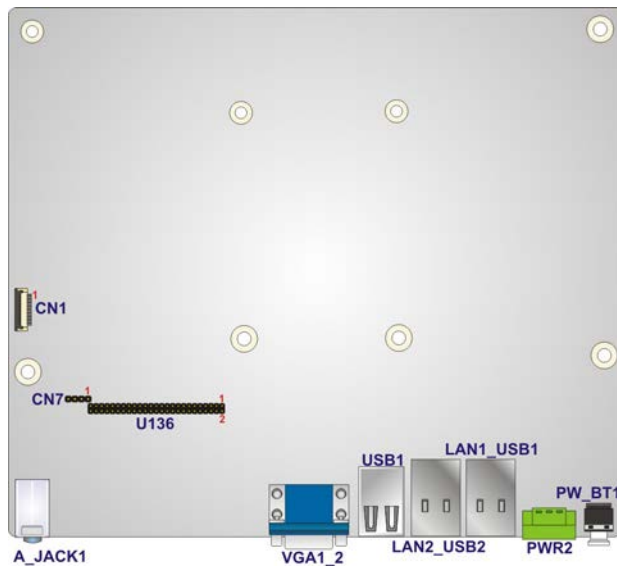

Figure 4-1: System Motherboard (Front)

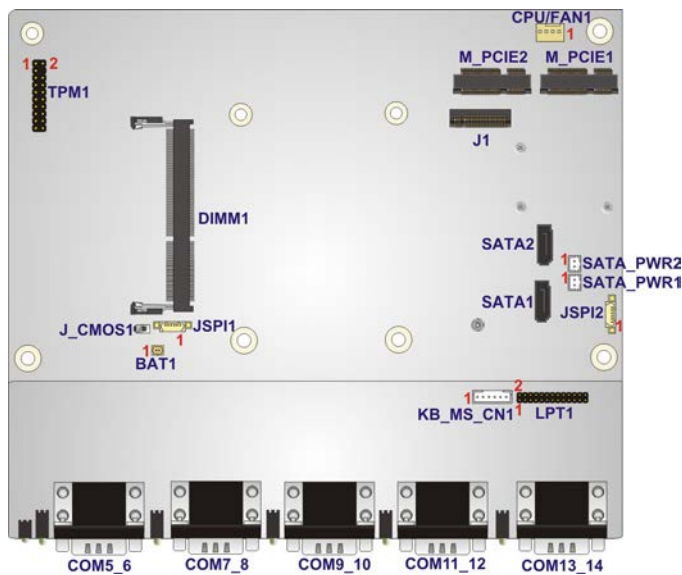

Figure 4-2: System Motherboard (Rear)

4.2 Internal Peripheral Connectors

The table below shows a list of the internal peripheral interface connectors on the system motherboard. Pinouts of these connectors can be found in the following sections.

Connector	Type	Label
Battery connector	2-pin wafer	BAT1
BIOS programming connector	6-pin wafer	JSPI1
CPU fan connector	4-pin wafer	CPU/FAN1
DDR4 SO-DIMM slots	DDR4 SO-DIMM slot	DIMM1
LPT connector	26-pin header	LPT1
M.2 slot, M-key	M.2 M-key slot	J1
EC debug connector	20-pin FPC connector	CN1
EC programming connector	6-pin wafer	JSPI2
Keyboard and mouse connector	6-pin wafer	KB_MS_CN1
PCIe mini Card	Full size	MPCIE1
PCIe mini Card	Full size/Half size	MPCIE2
SATA 6Gb/s drive connectors	7-pin SATA connector	SATA1, SATA2
SATA power connectors	2-pin wafer	SATA_PWR1, SATA_PWR2
TPM connector	20-pin header	TPM1

Table 4-1: Peripheral Interface Connectors

4.2.1 Battery Connector (BAT1)

PIN NO.	DESCRIPTION
1	VBATT
2	GND

Table 4-2: Battery Connector Pinouts (BAT1)

4.2.2 BIOS Programming Connector (JSPI1)

PIN NO.	DESCRIPTION	PIN NO.	DESCRIPTION
1	+3.3V_SPI_CON	2	SPI_CS#0_N
3	SPI_SO_N	4	SPI_CLK_N
5	SPI_SI_N	6	GND

Table 4-3: BIOS Programming Connector Pinouts (JSPI1)

4.2.3 CPU Fan Connector (CPU/FAN1)

PIN NO.	DESCRIPTION	PIN NO.	DESCRIPTION
1	GND	2	+V12S
3	FANIN1	4	FANOUT1

Table 4-4: CPU Fan Connector Pinouts (CPU/FAN1)

4.2.4 LPT Connector (LPT1)

PIN NO.	DESCRIPTION	PIN NO.	DESCRIPTION
1	RSTROBE#	14	GND
2	SIO_AFD#	15	RPD6
3	RPD0	16	GND
4	GND	17	RPD7
5	RPD1	18	GND
6	SIO_INIT#	19	SIO_ACK#
7	RPD2	20	GND
8	SIO_SLIN#	21	SIO_BUSY
9	RPD3	22	GND
10	GND	23	SIO_PE
11	RPD4	24	GND
12	GND	25	SIO_SLCT
13	RPD5	26	NC

Table 4-5: LPT connector Pinouts (LPT1)

TANK-620-ULT3 Embedded System

4.2.5 EC Debug Connector (CN1)

PIN NO.	DESCRIPTION	PIN NO.	DESCRIPTION
1	KSI0	11	KSO9
2	KSO0	12	KSO10
3	KSO1	13	KSO12
4	KSO2	14	KSI1
5	KSO3	15	KSO11
6	KSO4	16	KSI2
7	KSO5	17	KSI3
8	KSO6	18	GND
9	KSO7	19	GND
10	KSO8	20	GND

Table 4-6: EC Debug Connector Pinouts (CN1)

4.2.6 EC Programming Connector (JSPI2)

PIN NO.	DESCRIPTION	PIN NO.	DESCRIPTION
1	+V3.3M_SPI_CON_EC	2	SPI_CS#0_CN_EC
3	SPI_SO_SW_EC	4	SPI_CLK_SW_EC
5	SPI_SI_SW_EC	6	GND

Table 4-7: EC Programming Connector Pinouts (JSPI2)

4.2.7 Keyboard and mouse connector (KB_MS_CN1)

PIN NO.	DESCRIPTION	PIN NO.	DESCRIPTION
1	+5V_KBMS	2	MSDATA
3	MSCLK	4	KBDATA
5	KBCLK	6	KBGND

Table 4-8: Keyboard and mouse connector Pinouts (KB_MS_CN1)

4.2.8 SATA Power Connectors (SATA_PWR1, SATA_PWR2)

PIN NO.	DESCRIPTION
1	+V5S
2	GND

Table 4-9: SATA Power Connectors Pinouts (SATA_PWR1, SATA_PWR2)

4.2.9 TPM Connector (TPM1)

PIN NO.	DESCRIPTION	PIN NO.	DESCRIPTION
1	CLK_PCI_TPM	2	GND
3	LPC_FRAME#	4	NC
5	BUF_PLT_RST#	6	+V5S
7	LPC_AD3	8	LPC_AD2
9	+V3.3S	10	LPC_AD1
11	LPC_AD0	12	GND
13	SMB_CLK	14	SMB_DATA
15	+V3.3A	16	INT_SERIRQ
17	GND	18	PM_CLKRUN#
19	PM_ESPI_RST_EC_N	20	TPM_DRQ#0

Table 4-10: TPM Connector Pinouts (TPM1)

TANK-620-ULT3 Embedded System

4.3 External Interface Panel Connectors

The figure below shows the external peripheral interface connector (EPIC) panel.

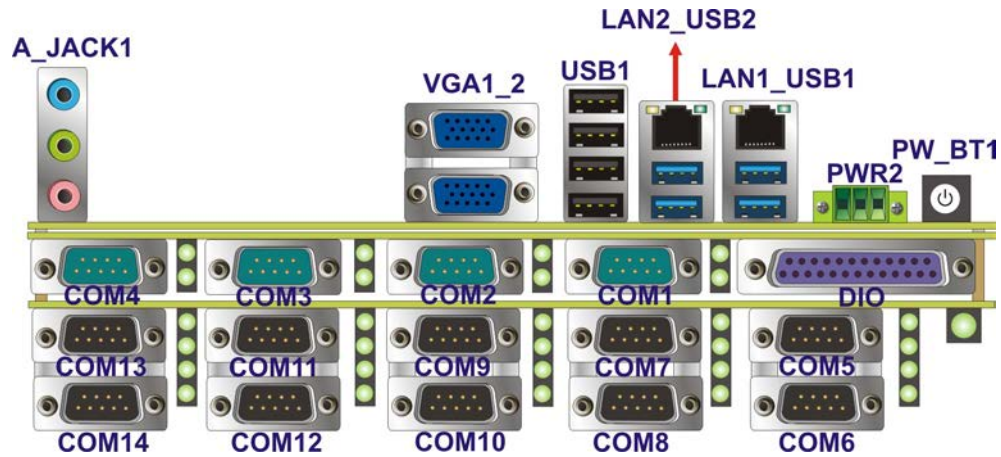

Figure 4-3: External Peripheral Interface Connector

The table below shows a list of the external interface panel connectors on the system motherboard. Pinouts of these connectors can be found in the following sections.

Connector	Type	Label
Audio jack (speaker out, line-out, mic)	Audio jack	A_JACK1
DIO connector	DB-25	DIO1
Ethernet and USB 3.0 connectors	RJ-45, USB 3.0 port	LAN1_USB1, LAN2_USB2
Power connector	3-pin terminal block	PWR2
RS-232 serial port connectors	DB-9	COM1~COM6
RS-232/422/485 serial port connectors	DB-9	COM7~COM14
USB 2.0 connectors	USB 2.0 port	USB1
VGA connectors	DB-15	VGA1_2

Table 4-11: Rear Panel Connectors

4.3.1 Audio Jack (A_JACK1)

PIN NO.	DESCRIPTION	PIN NO.	DESCRIPTION

1	Analog_GND	2	LMIC1-CONN-L
3	Analog_GND	4	MIC1-JD
5	LMIC1-CONN-R	22	LFRONT-L
23	Analog_GND	24	FRONT-JD
25	LFRONT-R	32	LOUT_AMP
33	Analog_GND	34	LINE2-JD
35	ROUT_AMP		

Table 4-12: Audio Jack Pinouts (A_JACK1)

4.3.2 DIO connector (DIO1)

PIN NO.	DESCRIPTION	PIN NO.	DESCRIPTION
1	D_IN0	14	D_OUT0
2	D_IN1	15	D_OUT1
3	D_IN2	16	D_OUT2
4	D_IN3	17	D_OUT3
5	D_8IN0	18	D_8OUT0
6	D_8IN1	19	D_8OUT1
7	D_8IN2	20	D_8OUT2
8	D_8IN3	21	D_8OUT3
9	D_8IN4	22	D_8OUT4
10	D_8IN5	23	D_8OUT5
11	D_8IN6	24	D_8OUT6
12	D_8IN7	25	D_8OUT7
13	GND		

Table 4-13: DIO connector Pinouts (DIO1)

4.3.3 Ethernet and USB 3.0 Connectors (LAN1_USB1)

PIN	DESCRIPTION	PIN	DESCRIPTION
R1	NC	R2	TRDP0
R3	TRDN0	R4	TRDP1
R5	TRDN1	R6	TRDP2
R7	TRDN2	R8	TRDP3

TANK-620-ULT3 Embedded System

PIN	DESCRIPTION	PIN	DESCRIPTION
R9	TRDN3	R10	GND
L1	L_1000-	L2	L_100-
L3	L_LINK_ACT-	L4	L_LINK_PWR
G1~G8	LAN1_GND		
U1	VCC_USB3_01	U2	USB_PN0-_R
U3	USB_PP0+_R	U4	GND
U5	USB3_RX0_N_R	U6	USB3_RX0_P_R
U7	GND	U8	USB3_TX0_N_C_R
U9	USB3_TX0_P_C_R	U10	VCC_USB3_01
U11	USB_PN1-_R	U12	USB_PP1+_R
U13	GND	U14	USB3_RX1_N_R
U15	USB3_RX1_P_R	U16	GND
U17	USB3_TX1_N_C_R	U18	USB3_TX1_P_C_R

Table 4-14: Ethernet and USB 2.0 Connectors (LAN1_USB1)

4.3.4 Ethernet and USB 3.0 Connectors (LAN2_USB2)

PIN	DESCRIPTION	PIN	DESCRIPTION
R1	NC	R2	TRD2P0
R3	TRD2N0	R4	TRD2P1
R5	TRD2N1	R6	TRD2P2
R7	TRD2N2	R8	TRD2P3
R9	TRD2N3	R10	GND
L1	L2_1000-	L2	L2_100-
L3	L2_LINK_ACT-	L4	L2_LINK_PWR
G1~G8	LAN2_GND		
U1	VCC_USB3_02	U2	USB_PN2-_R
U3	USB_PP2+_R	U4	GND
U5	USB3_RX2_N_R	U6	USB3_RX2_P_R
U7	GND	U8	USB3_TX2_N_C_R
U9	USB3_TX2_P_C_R	U10	VCC_USB3_02
U11	USB_PN3-_R	U12	USB_PP3+_R
U13	GND	U14	USB3_RX3_N_R

PIN	DESCRIPTION	PIN	DESCRIPTION
U15	USB3_RX3_P_R	U16	GND
U17	USB3_TX3_N_C_R	U18	USB3_TX3_P_C_R

Table 4-15: Ethernet and USB 2.0 Connectors (LAN2_USB2)

4.3.5 Power Connector (PWR2)

PIN NO.	DESCRIPTION	PIN NO.	DESCRIPTION
1	DC_IN	2	GND
3	GND		

Table 4-16: Power Connector Pinouts (PWR2)

4.3.6 RS-232 Serial Port Connectors (COM1~ COM6)

PIN NO.	DESCRIPTION	PIN NO.	DESCRIPTION
1	DCD	2	SIN
3	SOUT	4	DTR
5	GND	6	DSR
7	RTS	8	CTS
9	RI		

Table 4-17: RS-232 Serial Port Connectors Pinouts (COM1~COM6)

4.3.7 RS-232/422/485 Serial Port Connector (COM7~COM14)

PIN NO.	RS-232	RS-422	RS-485
1(10)	DCD	TXD422#	TXD485#
2(11)	RX	TXD422+	TXD485+
3(12)	TX	RXD422+	--
4(13)	DTR	RXD422#	--
5(14)	GND	--	--
6(15)	DSR	--	--
7(16)	RTS	--	--
8(17)	CTS	--	--
9(18)	RI	--	--

Table 4-18: RS-232/422/485 Serial Port Connector Pinout (COM7~COM14)

4.3.8 USB 2.0 Connectors (USB1)

PIN NO.	DESCRIPTION	PIN NO.	DESCRIPTION
1	USB_GND	2	USB_GND
3	USB_GND	4	USB_GND
5	USB_GND	6	USB_GND
11	+VCC_USB12	12	-DATA_USB1
13	+DATA_USB1	14	GND
21	+VCC_USB12	22	-DATA_USB2
23	+DATA_USB2	24	GND
31	+VCC_USB34	32	-DATA_USB3
33	+DATA_USB3	34	GND
41	+VCC_USB34	42	-DATA_USB4
43	+DATA_USB4	44	GND

Table 4-19: USB 2.0 Connectors Pinouts (USB1)

4.3.9 VGA Connectors (VGA1_2)

PIN NO.	DESCRIPTION	PIN NO.	DESCRIPTION
A1	BR	B1	BR2
A2	BG	B2	BG2
A3	BB	B3	BB2
A4	NC	B4	NC
A5	GND	B5	GND
A6	GNG	B6	GNG
A7	GNG	B7	GNG
A8	GNG	B8	GNG
A9	CRT_VCC	B9	CRT_VCC2
A10	CRT_PLUG#	B10	CRT_PLUG#2
A11	NC	B11	NC
A12	5VDDCDA	B12	5VDDCDA2
A13	5HSYNC	B13	5HSYNC2

A14	5VSYNC	B14	5VSYNC2
A15	5VDDCLK	B15	5VDDCLK2

Table 4-20: VGA Connectors Pinouts (VGA_21)

4.4 Jumper Settings

The buttons, jumper and switch on the system motherboard are listed in **Table 4-21**.

Connector	Type	Label
AT/ATX Mode select switch	switch	J_ATX_AT1
Clear CMOS button	button	J_CMOS1
System reset button	button	RST1

Table 4-21: Buttons, Jumper and Switch

4.4.1 AT/ATX Mode Select Switch (J_ATX_AT1)

Setting	Description
Short A-B	ATX Mode (Default)
Short B-C	AT Mode

Table 4-22: AT/ATX Mode Select Switch (J_ATX_AT1)

4.4.2 Clear CMOS Button (J_CMOS1)

Setting	Description
Open	Normal Operation (Default)
Push	Clear CMOS Setup

Table 4-23: Clear CMOS Button (J_CMOS1)

TANK-620-ULT3 Embedded System

4.4.3 System Reset Button (RST1)

Setting	Description
Open	Normal Operation (Default)
Push	System Restart

Table 4-24: System Reset Button (RST1)

Chapter

5

BIOS

TANK-620-ULT3 Embedded System

5.1 Introduction

The BIOS is programmed onto the BIOS chip. The BIOS setup program allows changes to certain system settings. This chapter outlines the options that can be changed.



NOTE:

Some of the BIOS options may vary throughout the life cycle of the product and are subject to change without prior notice.

5.1.1 Starting Setup

The UEFI BIOS is activated when the computer is turned on. The setup program can be activated in one of two ways.

1. Press the **DEL** or **F2** key as soon as the system is turned on or
2. Press the **DEL** or **F2** key when the “**Press DEL or F2 to enter SETUP**” message appears on the screen.

If the message disappears before the **DEL** or **F2** key is pressed, restart the computer and try again.

5.1.2 Using Setup

Use the arrow keys to highlight items, press **ENTER** to select, use the PageUp and PageDown keys to change entries, press **F1** for help and press **ESC** to quit. Navigation keys are shown in.

Key	Function
Up arrow	Move to previous item
Down arrow	Move to next item
Left arrow	Move to the item on the left hand side
Right arrow	Move to the item on the right hand side
+	Increase the numeric value or make changes

Key	Function
-	Decrease the numeric value or make changes
Page Up key	Increase the numeric value or make changes
Page Dn key	Decrease the numeric value or make changes
Esc key	Main Menu – Quit and not save changes into CMOS Status Page Setup Menu and Option Page Setup Menu -- Exit current page and return to Main Menu
F1	General help, only for Status Page Setup Menu and Option Page Setup Menu
F2	Previous values
F3	Load optimized defaults
F4	Save changes and Exit BIOS

Table 5-1: BIOS Navigation Keys

5.1.3 Getting Help

When **F1** is pressed a small help window describing the appropriate keys to use and the possible selections for the highlighted item appears. To exit the Help Window press **Esc** or the **F1** key again.

5.1.4 Unable to Reboot after Configuration Changes

If the computer cannot boot after changes to the system configuration is made, CMOS defaults. Use the jumper described in Chapter 2.

5.1.5 BIOS Menu Bar

The **menu bar** on top of the BIOS screen has the following main items:

- Main – Changes the basic system configuration.
- Advanced – Changes the advanced system settings.
- Chipset – Changes the chipset settings.
- Boot – Changes the system boot configuration.
- Security – Sets User and Supervisor Passwords.

TANK-620-ULT3 Embedded System

- Save & Exit – Selects exit options and loads default settings.

The following sections completely describe the configuration options found in the menu items at the top of the BIOS screen and listed above.

5.2 Main

The **Main** BIOS menu (**BIOS Menu 1**) appears when the **BIOS Setup** program is entered.

The **Main** menu gives an overview of the basic system information.

```

Aptio Setup Utility - Copyright (C) 2018 American Megatrends, Inc.
Main  Advanced  Chipset  Security  Boot  Save & Exit

BIOS Information
BIOS Vendor                American Megatrends
Core Version               5.11
Compliancy                 UEFI 2.4; PI 1.3
Project Version            SEV4AR05.BCN
Build Date and Time       08/10/2018 09:33:20

iWDD Vendor                iEi
iWDD Version               SEV4ER01.bin
Access Level               Administrator

Processor Information
Name                       SkyLake
Brand String               Intel(R) Celeron(R) CPU
                           3855U @ 1.60GHz
Frequency                  1500 MHz
Processor ID               406E3
Stepping                   D0/K0
Number of Processors       2Core(s) / 2Thread(s)
Microcode Revision         C2
GT Info                     GT1

IGFX VBIOS Version         1046
Memory RC Version          2.1.0.0
Total Memory                4096 MB
Memory Frequency            2133 MHz

PCH Information
Name                       SKL PCH-LP
PCH SKU                     PCH-LP Mobile (U)
                           Premium SKU
Stepping                    21/C1
LAN PHY Revision           N/A

ME FW Version               11.8.50.3425
ME Firmware SKU             Consumer SKU

SPI Clock Frequency
DDFR Support                Unsupported
Read Status Clock Frequency 17 MHz
Write Status Clock Frequency 48 MHz
Fast Read Status Clock Frequency 48 MHz

System Date                 [Tue 09/25/2018]
System Time                 [15:43:27]

Set the Date. Use Tab to
switch between Data
elements.

-----
<->: Select Screen
^ v: Select Item
Enter: Select
+/-: Change Opt.
F1: General Help
F2: Previous Values
F3: Optimized Defaults
F4: Save & Exit
ESC: Exit

Version 2.18.1263. Copyright (C) 2018 American Megatrends, Inc.
  
```

BIOS Menu 1: Main

TANK-620-ULT3 Embedded System

The Main menu has two user configurable fields:

→ **System Date [xx/xx/xx]**

Use the **System Date** option to set the system date. Manually enter the day, month and year.

→ **System Time [xx:xx:xx]**

Use the **System Time** option to set the system time. Manually enter the hours, minutes and seconds.

5.3 Advanced

Use the **Advanced** menu (**BIOS Menu 2**) to configure the CPU and peripheral devices through the following sub-menus:



WARNING!

Setting the wrong values in the sections below may cause the system to malfunction. Make sure that the settings made are compatible with the hardware.

```

Aptio Setup Utility - Copyright (C) 2018 American Megatrends, Inc.
  Advanced
> Trusted Computing
> ACPI Settings
> F81866 Super IO Configuration
> Hardware Monitor
> F81866SEC Super IO Configuration
> IT8528TRD Super IO Configuration
> RTC Wake Settings
> Serial Port Console Redirection
> CPU Configuration
> SATA Configuration
> USB Configuration
> iEi Feature

CPU Configuration
Parameters

-----
<->: Select Screen
↑ ↓: Select Item
EnterSelect
+/-: Change Opt.
F1: General Help
F2: Previous Values
F3: Optimized Defaults
F4: Save & Exit
ESC: Exit

Version 2.18.1263. Copyright (C) 2018 American Megatrends, Inc.
  
```

BIOS Menu 2: Advanced

5.3.1 Trusted Computing

Use the **Trusted Computing** menu (**BIOS Menu 3**) to configure settings related to the Trusted Computing Group (TCG) Trusted Platform Module (TPM).

```

Aptio Setup Utility - Copyright (C) 2018 American Megatrends, Inc.
  Advanced
Configuration
Security Device Support          [Disable]
NO Security Device Found

Enables or Disables BIOS
support for security
device. O.S. will not
show Security Device.
TCG EFI protocol and
INT1A interface will not
be available.

-----
<->: Select Screen
↑ ↓: Select Item
EnterSelect
+/-: Change Opt.
F1: General Help
F2: Previous Values
F3: Optimized Defaults
F4: Save & Exit
ESC: Exit

Version 2.18.1263. Copyright (C) 2018 American Megatrends, Inc.
  
```

BIOS Menu 3: Trusted Computing

TANK-620-ULT3 Embedded System

→ Security Device Support [Disable]

Use the **Security Device Support** option to configure support for the security device.

- **Disable** **DEFAULT** Security device support is disabled.
- **Enable** Security device support is enabled.

5.3.2 ACPI Settings

The **ACPI Settings** menu (**BIOS Menu 4**) configures the Advanced Configuration and Power Interface (ACPI) options.

```

Aptio Setup Utility - Copyright (C) 2018 American Megatrends, Inc.
-----
Advanced
-----
ACPI Settings
ACPI Sleep State          [S3 (Suspend to RAM)]
-----
Select the highest ACPI
sleep state the system
will enter when the
SUSPEND button is
pressed.

-----

<->: Select Screen
↑ ↓: Select Item
Enter>Select
+/-: Change Opt.
F1:  General Help
F2:  Previous Values
F3:  Optimized Defaults
F4:  Save & Exit
ESC: Exit

Version 2.18.1263. Copyright (C) 2018 American Megatrends, Inc.

```

BIOS Menu 4: ACPI Configuration

→ ACPI Sleep State [S3 (Suspend to RAM)]

Use the **ACPI Sleep State** option to specify the sleep state the system enters when it is not being used.

- **S3 (Suspend to RAM)** The caches are flushed and the CPU is powered off. Power to the RAM is maintained. The computer returns slower to a working state, but more power is saved.

5.3.3 F81866 Super IO Configuration

Use the **F81866 Super IO Configuration** menu (**BIOS Menu 5**) to set or change the configurations for the serial ports.

```

Aptio Setup Utility - Copyright (C) 2018 American Megatrends, Inc.
  Advanced
F81866 Super IO Configuration                               Set Parameters of Serial
                                                           Port 3 (COMC)
F81866 Super IO Chip                                     F81866
> Serial Port 3 Configuration
> Serial Port 4 Configuration
> Serial Port 5 Configuration
> Serial Port 6 Configuration
> Serial Port 7 Configuration
> Serial Port 8 Configuration
> Parallel Port Configuration
                                                           -----
                                                           ←→: Select Screen
                                                           ↑ ↓: Select Item
                                                           EnterSelect
                                                           +/-: Change Opt.
                                                           F1: General Help
                                                           F2: Previous Values
                                                           F3: Optimized Defaults
                                                           F4: Save & Exit
                                                           ESC: Exit
Version 2.18.1263. Copyright (C) 2018 American Megatrends, Inc.
    
```

BIOS Menu 5: F81866 Super IO Configuration

5.3.3.1 Serial Port n Configuration

Use the **Serial Port n Configuration** menu (**BIOS Menu 6**) to configure the serial port n.

```

Aptio Setup Utility - Copyright (C) 2018 American Megatrends, Inc.
  Advanced
Serial Port n Configuration                               Enable or Disable Serial
                                                           Port (COM)
Serial Port                                             [Enabled]
Device Settings                                         IO=3F8h; IRQ=4
                                                           -----
                                                           ←→: Select Screen
                                                           ↑ ↓: Select Item
                                                           EnterSelect
                                                           +/-: Change Opt.
                                                           F1: General Help
                                                           F2: Previous Values
                                                           F3: Optimized Defaults
                                                           F4: Save & Exit
                                                           ESC: Exit
Version 2.18.1263. Copyright (C) 2018 American Megatrends, Inc.
    
```

BIOS Menu 6: Serial Port n Configuration Menu

TANK-620-ULT3 Embedded System

5.3.3.1.1 Serial Port 3 Configuration

→ Serial Port [Enabled]

Use the **Serial Port** option to enable or disable the serial port.

→ **Disabled** Disable the serial port

→ **Enabled** **DEFAULT** Enable the serial port

→ Device Settings [IO=3E8h; IRQ=4]

Use the **Device Settings** option to view the serial port IO port address and interrupt address.

→ **IO=3E8h; IRQ=4** **DEFAULT** Serial Port I/O port address is 3E8h and the interrupt address is IRQ4

5.3.3.1.2 Serial Port 4 Configuration

→ Serial Port [Enabled]

Use the **Serial Port** option to enable or disable the serial port.

→ **Disabled** Disable the serial port

→ **Enabled** **DEFAULT** Enable the serial port

→ Device Settings [IO=2F8h; IRQ=3]

Use the **Device Settings** option to view the serial port IO port address and interrupt address.

→ **IO=2F8h; IRQ=3** **DEFAULT** Serial Port I/O port address is 2F8h and the interrupt address is IRQ3

5.3.3.1.3 Serial Port 5 Configuration

→ Serial Port [Enabled]

Use the **Serial Port** option to enable or disable the serial port.

→ **Disabled** Disable the serial port

→ **Enabled** **DEFAULT** Enable the serial port

→ Device Settings [IO=2C0h; IRQ=10]

Use the **Device Settings** option to view the serial port IO port address and interrupt address.

→ **IO=2C0h; IRQ=10** **DEFAULT** Serial Port I/O port address is 2C0h and the interrupt address is IRQ10

5.3.3.1.4 Serial Port 6 Configuration

→ Serial Port [Enabled]

Use the **Serial Port** option to enable or disable the serial port.

→ **Disabled** Disable the serial port

→ **Enabled** **DEFAULT** Enable the serial port

→ Device Settings [IO=2C8h; IRQ=10]

Use the **Device Settings** option to view the serial port IO port address and interrupt address.

→ **IO=2C8h; IRQ=10** **DEFAULT** Serial Port I/O port address is 2C8h and the interrupt address is IRQ10

TANK-620-ULT3 Embedded System

5.3.3.1.5 Serial Port 7 Configuration

→ Serial Port [Enabled]

Use the **Serial Port** option to enable or disable the serial port.

- **Disabled** Disable the serial port
- **Enabled** **DEFAULT** Enable the serial port

→ Device Settings [IO=2D0h; IRQ=10]

Use the **Device Settings** option to view the serial port IO port address and interrupt address.

- **IO=2D0h; IRQ=10** **DEFAULT** Serial Port I/O port address is 2D0h and the interrupt address is IRQ10

→ Device Mode [RS232]

Use the **Device Mode** option to select the serial port mode.

- **RS232** **DEFAULT** Enables serial port RS-232 support.
- **RS422** Enables serial port RS-422 support.
- **RS485** Enables serial port RS-485 support.

5.3.3.1.6 Serial Port 8 Configuration

→ Serial Port [Enabled]

Use the **Serial Port** option to enable or disable the serial port.

- **Disabled** Disable the serial port
- **Enabled** **DEFAULT** Enable the serial port

→ Device Settings [IO=2D8h; IRQ=10]

Use the **Device Settings** option to view the serial port IO port address and interrupt address.

→ **IO=2D8h; IRQ=10** **DEFAULT** Serial Port I/O port address is 2D8h and the interrupt address is IRQ10

→ Device Mode [RS232]

Use the **Device Mode** option to select the serial port mode.

- **RS232** **DEFAULT** Enables serial port RS-232 support.
- **RS422** Enables serial port RS-422 support.
- **RS485** Enables serial port RS-485 support.

5.3.3.2 Parallel Port Configuration

Use the **Parallel Port Configuration** menu (**BIOS Menu 7**) to configure the parallel port.

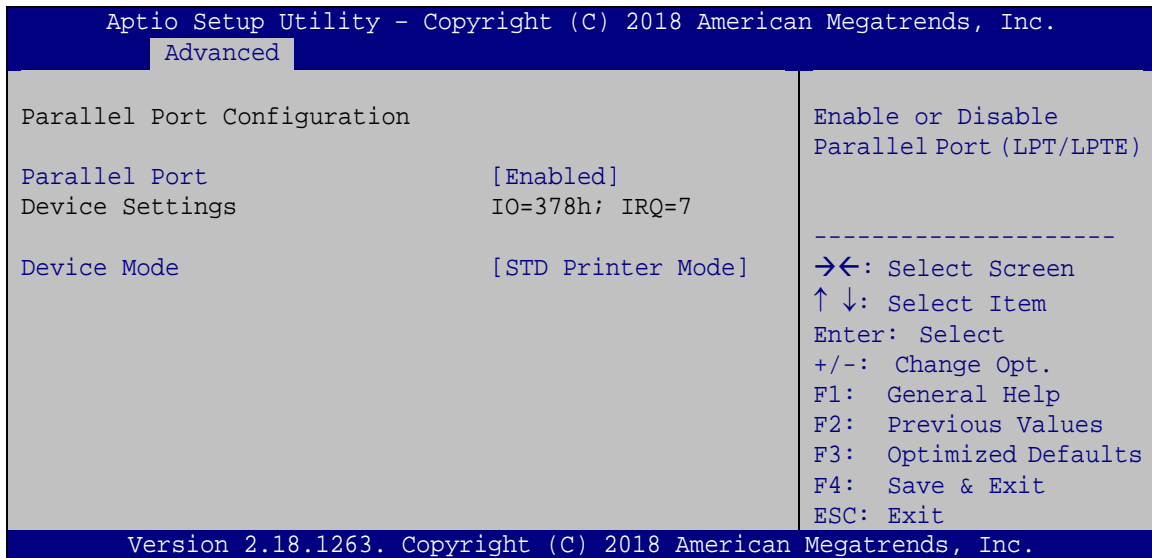

BIOS Menu 7: Parallel Port Configuration Menu

→ Parallel Port [Enabled]

Use the **Parallel Port** option to enable or disable the parallel port.

TANK-620-ULT3 Embedded System

- ➔ **Disabled** Disable the parallel port
- ➔ **Enabled** **DEFAULT** Enable the parallel port

➔ **Change Settings [IO=378h; IRQ=7]**

Use the **Change Settings** option to change the parallel port IO port address and interrupt address.

- ➔ **IO=378h; IRQ=7** **DEFAULT** Parallel Port I/O port address is 378h and the interrupt address is IRQ7

➔ **Device Mode [STD Printer Mode]**

Use the **Device Mode** option to select the mode the parallel port operates in. Configuration options are listed below.

- STD Printer Mode **Default**
- SPP Mode
- EPP-1.9 and SPP Mode
- EPP-1.7 and SPP Mode
- ECP Mode
- ECP and EPP 1.9 Mode
- ECP and EPP 1.7 Mode

5.3.4 Hardware Monitor

The **Hardware Monitor** menu (**BIOS Menu 8**) shows the operating temperature, fan speeds and system voltages.

```

Aptio Setup Utility - Copyright (C) 2018 American Megatrends, Inc.
Advanced
PC Health Status
System Temperature      :+37 °C
CPU Temperature        :+0 °C
Fan1 Speed             :N/A
+V3.3A                 :+3.321 V
+V5S                   :+5.045 V
+V3.3S                 :+3.321 V
+VCCCORE               :+0.873 V
+VDDQ                  :+1.202 V
+V3.3S                 :+3.290 V
DC_IN_EC               :+19.029 V

Tcc Activation Offset   0

F81866 Smart Fan Function [Enabled]
> F81866 Smart Fan Mode Configuration

Offset from factory Tcc
activation temperature.
Tcc Activation Offset
range is 0 to 63.

-----
<->: Select Screen
↑ ↓: Select Item
EnterSelect
+/-: Change Opt.
F1: General Help
F2: Previous Values
F3: Optimized
Defaults
F4: Save & Exit
ESC: Exit

Version 2.18.1263. Copyright (C) 2018 American Megatrends, Inc.
  
```

BIOS Menu 8: F81866 H/W Monitor

➔ PC Health Status

The following system parameters and values are shown. The system parameters that are monitored are:

- System Temperatures:
 - System Temperature
 - CPU Temperature
- Fan Speeds:
 - Fan1 Speed
- Voltages:
 - +V3.3A
 - +V5S
 - +V3.3S
 - +VCCCORE

TANK-620-ULT3 Embedded System

- +VDDQ
- +V3.3S
- DC_IN_EC

→ Tcc Activation Offset

Use the **Tcc Activation Offset** option to change the **Tcc Activation Offset** value. If CPU Temperature reaches Tcc Activation Offset then reduces CPU Frequency.

- Minimum Value: 0°C
- Maximum Value: 63°C

→ F81866 Smart Fan Function [Enabled]

Use the **F81866 Smart Fan Function** option to enable or disable the smart fan function.

- **Disabled** Disables the smart fan function.
- **Enabled** **DEFAULT** Enables the smart fan function.

5.3.4.1 Smart Fan Mode Configuration

Use the **Smart Fan Mode Configuration** submenu (**BIOS Menu 9**) to configure the smart fan temperature and speed settings.

```

Aptio Setup Utility - Copyright (C) 2018 American Megatrends, Inc.
  Advanced
F81866 Smart Fan Function
FAN1 Smart Fan Control      [Auto Duty-Cycle Mode]
CPU Temperature 1          60
CPU Temperature 2          50
CPU Temperature 3          40
CPU Temperature 4          30
Smart Fan Mode Select
-----
<=>: Select Screen
↑ ↓: Select Item
Enter>Select
+/-: Change Opt.
F1:  General Help
F2:  Previous Values
F3:  Optimized
     Defaults
F4:  Save & Exit
ESC: Exit
Version 2.18.1263. Copyright (C) 2018 American Megatrends, Inc.
  
```

BIOS Menu 9: Smart Fan Mode Configuration

→ **FAN1 Smart Fan Control [Auto Duty-Cycle Mode]**

Use the **FAN1 Smart Fan Control** option to configure the CPU Smart Fan.

- **Manual Duty Mode** The fan spins at the speed set in Manual by Duty Cycle settings
- **Auto Duty-Cycle Mode DEFAULT** The fan adjusts its speed using Auto by Duty-Cycle settings

→ **CPU Temperature n**

Use the + or – key to change the fan **CPU Temperature n** value. Enter a decimal number between 1 and 100.

5.3.5 F81866SEC Super IO Configuration

Use the **F81866SEC Super IO Configuration** menu (**BIOS Menu 10**) to set or change the configurations for the serial ports.

```
Aptio Setup Utility - Copyright (C) 2018 American Megatrends, Inc.  
  Advanced  
F81866SEC Super IO Configuration  
Super IO Chip                          F81866SEC  
> Serial Port 9 Configuration  
> Serial Port 10 Configuration  
> Serial Port 11 Configuration  
> Serial Port 12 Configuration  
> Serial Port 13 Configuration  
> Serial Port 14 Configuration  
Set Parameters of Serial Port 9 (COM1)  
-----  
←→: Select Screen  
↑ ↓: Select Item  
Enter>Select  
+/-: Change Opt.  
F1: General Help  
F2: Previous Values  
F3: Optimized Defaults  
F4: Save & Exit  
ESC: Exit  
Version 2.18.1263. Copyright (C) 2018 American Megatrends, Inc.
```

BIOS Menu 10: F81866 Super IO Configuration

TANK-620-ULT3 Embedded System

5.3.5.1 Serial Port n Configuration

Use the **Serial Port n Configuration** menu (**BIOS Menu 11**) to configure the serial port n.

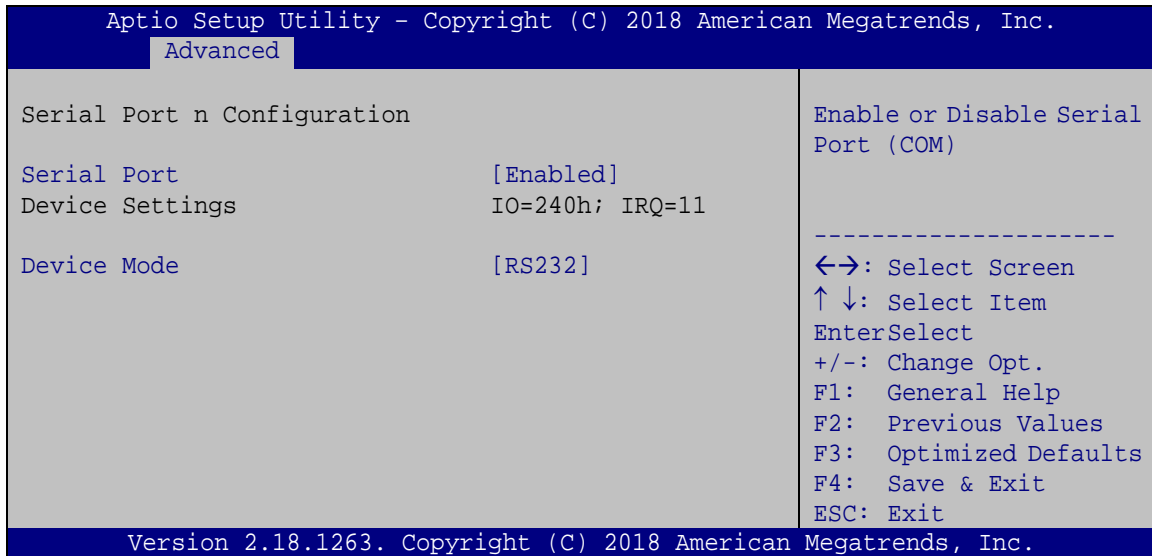

BIOS Menu 11: Serial Port n Configuration Menu

5.3.5.1.1 Serial Port 9 Configuration

→ Serial Port [Enabled]

Use the **Serial Port** option to enable or disable the serial port.

- **Disabled** Disable the serial port
- **Enabled** **DEFAULT** Enable the serial port

→ Device Settings [IO=240h; IRQ=11]

Use the **Device Settings** option to view the serial port IO port address and interrupt address.

- **IO=240h; IRQ=11** **DEFAULT** Serial Port I/O port address is 240h and the interrupt address is IRQ11

→ Device Mode [RS232]

Use the **Device Mode** option to select the serial port mode.

- **RS232** **DEFAULT** Enables serial port RS-232 support.
- **RS422** Enables serial port RS-422 support.
- **RS485** Enables serial port RS-485 support.

5.3.5.1.2 Serial Port 10 Configuration**→ Serial Port [Enabled]**

Use the **Serial Port** option to enable or disable the serial port.

- **Disabled** Disable the serial port
- **Enabled** **DEFAULT** Enable the serial port

→ Device Settings [IO=248h; IRQ=11]

Use the **Device Settings** option to view the serial port IO port address and interrupt address.

- **IO=248h; IRQ=11** **DEFAULT** Serial Port I/O port address is 248h and the interrupt address is IRQ11

→ Device Mode [RS232]

Use the **Device Mode** option to select the serial port mode.

- **RS232** **DEFAULT** Enables serial port RS-232 support.
- **RS422** Enables serial port RS-422 support.
- **RS485** Enables serial port RS-485 support.

TANK-620-ULT3 Embedded System

5.3.5.1.3 Serial Port 11 Configuration

→ Serial Port [Enabled]

Use the **Serial Port** option to enable or disable the serial port.

→ **Disabled** Disable the serial port

→ **Enabled** **DEFAULT** Enable the serial port

→ Device Settings [IO=250h; IRQ=11]

Use the **Device Settings** option to view the serial port IO port address and interrupt address.

→ **IO=250h; IRQ=11** **DEFAULT** Serial Port I/O port address is 250h and the interrupt address is IRQ11

→ Device Mode [RS232]

Use the **Device Mode** option to select the serial port mode.

→ **RS232** **DEFAULT** Enables serial port RS-232 support.

→ **RS422** Enables serial port RS-422 support.

→ **RS485** Enables serial port RS-485 support.

5.3.5.1.4 Serial Port 12 Configuration

→ Serial Port [Enabled]

Use the **Serial Port** option to enable or disable the serial port.

→ **Disabled** Disable the serial port

→ **Enabled** **DEFAULT** Enable the serial port

→ Device Settings [IO=258h; IRQ=11]

Use the **Device Settings** option to view the serial port IO port address and interrupt address.

→ IO=258h; IRQ=11 DEFAULT Serial Port I/O port address is 258h and the interrupt address is IRQ11

→ Device Mode [RS232]

Use the **Device Mode** option to select the serial port mode.

→ RS232 DEFAULT Enables serial port RS-232 support.

→ RS422 Enables serial port RS-422 support.

→ RS485 Enables serial port RS-485 support.

5.3.5.1.5 Serial Port 13 Configuration**→ Serial Port [Enabled]**

Use the **Serial Port** option to enable or disable the serial port.

→ Disabled Disable the serial port

→ Enabled DEFAULT Enable the serial port

→ Device Settings [IO=260h; IRQ=11]

Use the **Device Settings** option to view the serial port IO port address and interrupt address.

→ IO=260h; IRQ=11 DEFAULT Serial Port I/O port address is 260h and the interrupt address is IRQ11

→ Device Mode [RS232]

Use the **Device Mode** option to select the serial port mode.

TANK-620-ULT3 Embedded System

- **RS232** **DEFAULT** Enables serial port RS-232 support.
- **RS422** Enables serial port RS-422 support.
- **RS485** Enables serial port RS-485 support.

5.3.5.1.6 Serial Port 14 Configuration

→ **Serial Port [Enabled]**

Use the **Serial Port** option to enable or disable the serial port.

- **Disabled** Disable the serial port
- **Enabled** **DEFAULT** Enable the serial port

→ **Device Settings [IO=268h; IRQ=11]**

Use the **Device Settings** option to view the serial port IO port address and interrupt address.

- **IO=268h; IRQ=11** **DEFAULT** Serial Port I/O port address is 268h and the interrupt address is IRQ11

→ **Device Mode [RS232]**

Use the **Device Mode** option to select the serial port mode.

- **RS232** **DEFAULT** Enables serial port RS-232 support.
- **RS422** Enables serial port RS-422 support.
- **RS485** Enables serial port RS-485 support.

5.3.6 IT8528TRD Super IO Configuration

Use the **IT8528TRD Super IO Configuration** menu (**BIOS Menu 12**) to set or change the configurations for the serial ports.

```

Aptio Setup Utility - Copyright (C) 2018 American Megatrends, Inc.
  Advanced
IT8528TRD Super IO Configuration
Super IO Chip                IT8528TRD
> Serial Port 1 Configuration
> Serial Port 2 Configuration

Set Parameters of Serial
Port 1 (COMA)

-----
<->: Select Screen
↑ ↓: Select Item
EnterSelect
+/-: Change Opt.
F1:  General Help
F2:  Previous Values
F3:  Optimized Defaults
F4:  Save & Exit
ESC: Exit

Version 2.18.1263. Copyright (C) 2018 American Megatrends, Inc.
  
```

BIOS Menu 12: F81866 Super IO Configuration

5.3.6.1 Serial Port n Configuration

Use the **Serial Port n Configuration** menu (**BIOS Menu 13**) to configure the serial port n.

```

Aptio Setup Utility - Copyright (C) 2018 American Megatrends, Inc.
  Advanced
Serial Port n Configuration
Serial Port                [Enabled]
Device Settings            IO=288h; IRQ=6

Enable or Disable Serial
Port (COM)

-----
<->: Select Screen
↑ ↓: Select Item
EnterSelect
+/-: Change Opt.
F1:  General Help
F2:  Previous Values
F3:  Optimized Defaults
F4:  Save & Exit
ESC: Exit

Version 2.18.1263. Copyright (C) 2018 American Megatrends, Inc.
  
```

BIOS Menu 13: Serial Port n Configuration Menu

TANK-620-ULT3 Embedded System

5.3.6.1.1 Serial Port 1 Configuration

→ Serial Port [Enabled]

Use the **Serial Port** option to enable or disable the serial port.

→ **Disabled** Disable the serial port

→ **Enabled** **DEFAULT** Enable the serial port

→ Device Settings [IO=288h; IRQ=6]

Use the **Device Settings** option to view the serial port IO port address and interrupt address.

→ **IO=288h; IRQ=6** **DEFAULT** Serial Port I/O port address is 288h and the interrupt address is IRQ6

5.3.6.1.2 Serial Port 2 Configuration

→ Serial Port [Enabled]

Use the **Serial Port** option to enable or disable the serial port.

→ **Disabled** Disable the serial port

→ **Enabled** **DEFAULT** Enable the serial port

→ Device Settings [IO=2E8h; IRQ=6]

Use the **Device Settings** option to view the serial port IO port address and interrupt address.

→ **IO=2E8h; IRQ=6** **DEFAULT** Serial Port I/O port address is 2E8h and the interrupt address is IRQ6

5.3.7 RTC Wake Settings

The **RTC Wake Settings** menu (**BIOS Menu 14**) configures RTC wake event.

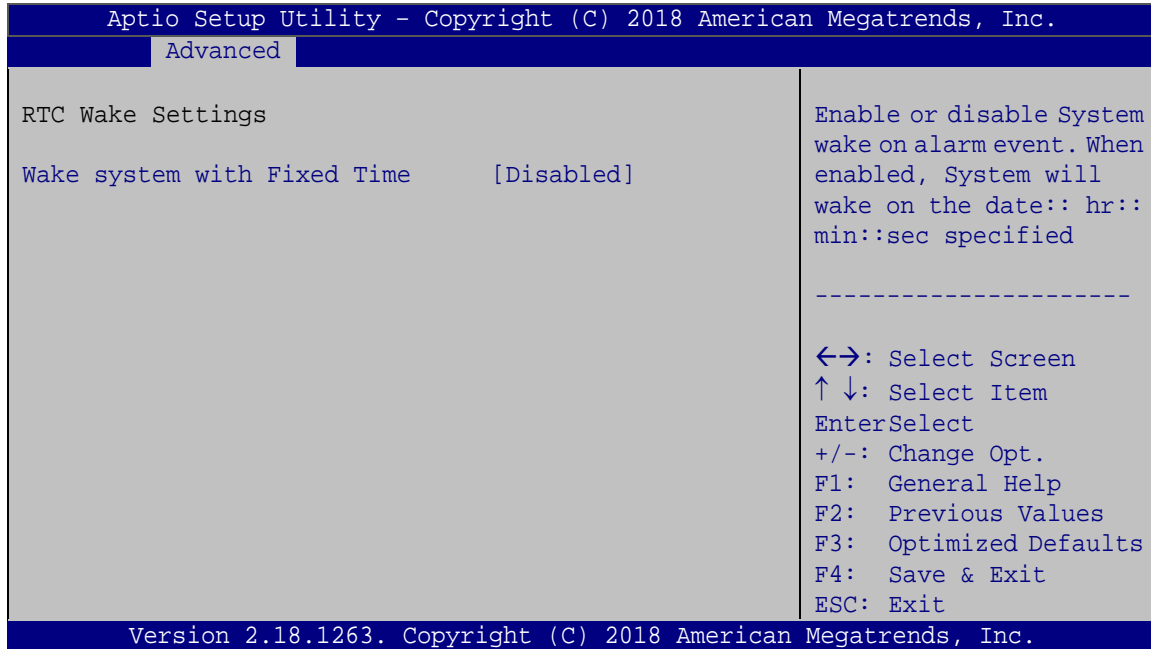

BIOS Menu 14: RTC Wake Settings

→ Wake System with Fixed Time [Disabled]

Use the **Wake System with Fixed Time** option to specify the time the system should be roused from a suspended state.

- **Disabled** **DEFAULT** The real time clock (RTC) cannot generate a wake event
- **Enabled** If selected, the following appears with values that can be selected:
 - *Wake up every day
 - *Wake up date
 - *Wake up hour
 - *Wake up minute
 - *Wake up second

After setting the alarm, the computer turns itself on from a suspend state when the alarm goes off.

TANK-620-ULT3 Embedded System

5.3.8 Serial Port Console Redirection

The **Serial Port Console Redirection** menu (**BIOS Menu 15**) allows the console redirection options to be configured. Console redirection allows users to maintain a system remotely by re-directing keyboard input and text output through the serial port.

```

Aptio Setup Utility - Copyright (C) 2018 American Megatrends, Inc.
  Advanced
COM1
  Console Redirection          [Disabled]
> Console Redirection Settings
COM2
  Console Redirection          [Disabled]
> Console Redirection Settings
COM3
  Console Redirection          [Disabled]
> Console Redirection Settings
COM4
  Console Redirection          [Disabled]
> Console Redirection Settings
COM5
  Console Redirection          [Disabled]
> Console Redirection Settings
COM6
  Console Redirection          [Disabled]
> Console Redirection Settings
COM7
  Console Redirection          [Disabled]
> Console Redirection Settings
COM8
  Console Redirection          [Disabled]
> Console Redirection Settings
COM9
  Console Redirection          [Disabled]
> Console Redirection Settings
COM10
  Console Redirection          [Disabled]
> Console Redirection Settings
COM11
  Console Redirection          [Disabled]
> Console Redirection Settings
COM12
  Console Redirection          [Disabled]
> Console Redirection Settings
COM13
  Console Redirection          [Disabled]
> Console Redirection Settings
COM14
  Console Redirection          [Disabled]
> Console Redirection Settings
-----
<=>: Select Screen
↑ ↓: Select Item
Enter>Select
+/-: Change Opt.
F1:  General Help
F2:  Previous Values
F3:  Optimized Defaults
F4:  Save & Exit
ESC: Exit
Version 2.18.1263. Copyright (C) 2018 American Megatrends, Inc.
  
```

BIOS Menu 15: Serial Port Console Redirection

→ Console Redirection [Disabled]

Use **Console Redirection** option to enable or disable the console redirection function.

- **Disabled** **DEFAULT** Disabled the console redirection function
- **Enabled** Enabled the console redirection function

5.3.8.1 Console Redirection Settings

The **Console Redirection Settings** menu (**BIOS Menu 16**) allows the console redirection options to be configured. The option is active when Console Redirection option is enabled.

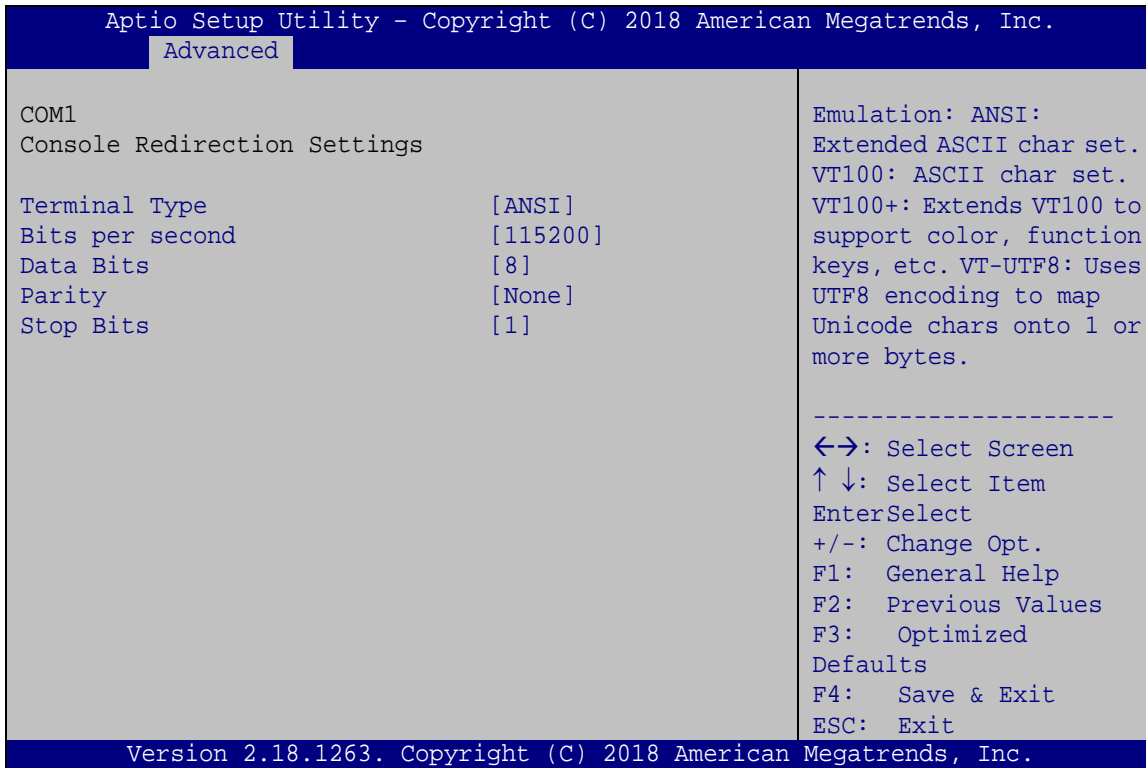

BIOS Menu 16: Console Redirection Settings

→ Terminal Type [ANSI]

Use the **Terminal Type** option to specify the remote terminal type..

- **VT100** The target terminal type is VT100
- **VT100+** The target terminal type is VT100+

TANK-620-ULT3 Embedded System

- ➔ **VT-UTF8** The target terminal type is VT-UTF8
- ➔ **ANSI** **DEFAULT** The target terminal type is ANSI

➔ **Bits per second [115200]**

Use the **Bits per second** option to specify the transmission speed of the serial port.

- ➔ **9600** The transmission speed is 9600
- ➔ **19200** The transmission speed is 19200
- ➔ **38400** The transmission speed is 38400
- ➔ **57600** The transmission speed is 57600
- ➔ **115200** **DEFAULT** The transmission speed is 115200

➔ **Data Bits [8]**

Use the **Data Bits** option to specify the number of data bits.

- ➔ **7** Sets the data bits at 7.
- ➔ **8** **DEFAULT** Sets the data bits at 8.

➔ **Parity [None]**

Use the **Parity** option to specify the parity bit that can be sent with the data bits for detecting the transmission errors.

- ➔ **None** **DEFAULT** No parity bit is sent with the data bits.
- ➔ **Even** The parity bit is 0 if the number of ones in the data bits is even.
- ➔ **Odd** The parity bit is 0 if the number of ones in the data bits is odd.
- ➔ **Mark** The parity bit is always 1. This option does not provide error detection.

→ **Space**

The parity bit is always 0. This option does not provide error detection.

→ **Stop Bits [1]**

Use the **Stop Bits** option to specify the number of stop bits used to indicate the end of a serial data packet. Communication with slow devices may require more than 1 stop bit.

→ **1** **DEFAULT** Sets the number of stop bits at 1.

→ **2** Sets the number of stop bits at 2.

5.3.9 CPU Configuration

Use the **CPU Configuration** menu (**BIOS Menu 17**) to enter the **CPU Information** submenu or enable Intel Virtualization Technology.

TANK-620-ULT3 Embedded System

```

Aptio Setup Utility - Copyright (C) 2018 American Megatrends, Inc.
  Advanced
CPU Configuration
Intel(R) Celeron(R) CPU 3855U @ 1.60GHz
CPU Signature          406E3
Microcode Patch       C2
Max CPU Speed         1600 MHz
Min CPU Speed         400 MHz
CPU Speed             1500 MHz
Processor Cores       2
Hyper Threading Technology Not Supported
Intel VT-x Technology Supported
Intel SMX Technology  Not Supported
64-bit               Supported
EIST Technology       Supported

L1 Data Cache        32 KB x 2
L1 Code Cache        32 KB x 2
L2 Cache             256 KB x 2
L3 Cache             3 MB
L4 Cache             Not Present

Active Processor Cores [All]
Intel Virtualization Technology [Disabled]
Intel(R) SpeedStep(tm) [Enabled]
CPU C State          [Disabled]

Number of cores to
enable in each
processor package.
-----
-
<->: Select Screen
^ v: Select Item
Enter>Select
+/-: Change Opt.
F1:  General Help
F2:  Previous Values
F3:  Optimized
Defaults
F4:  Save & Exit
ESC: Exit

Version 2.18.1263. Copyright (C) 2018 American Megatrends, Inc.
  
```

BIOS Menu 17: CPU Configuration

The CPU Configuration menu (**BIOS Menu 17**) lists the following CPU details:

- Processor Type: Lists the brand name of the CPU being used
- CPU Signature: Lists the CPU signature value.
- Microcode Patch: Lists the microcode patch being used.
- Max CPU Speed: Lists the maximum CPU processing speed.
- Min CPU Speed: Lists the minimum CPU processing speed.
- CPU Speed: Lists the CPU processing speed
- Processor Cores: Lists the number of the processor cores
- Hyper Threading Technology: Indicates if Intel Hyper Threading Technology is supported by the CPU.
- Intel VT-x Technology: Indicates if Intel VT-x Technology is supported by the CPU.

- Intel SMX Technology: Indicates if Intel SMX Technology is supported by the CPU.
- 64-bit: Indicates if 64-bit is supported by the CPU.
- EIST Technology: Indicates if Intel EIST Technology is supported by the CPU.
- L1 Data Cache: Lists the amount of data storage space on the L1 cache.
- L1 Code Cache: Lists the amount of code storage space on the L1 cache.
- L2 Cache: Lists the amount of storage space on the L2 cache.
- L3 Cache: Lists the amount of storage space on the L3 cache.
- L4 Cache: Lists the amount of storage space on the L4 cache.

→ Active Processor Cores [All]

Use the **Active Processor Cores** option to configure the number of the active processor cores.

- **All** **DEFAULT** Active all of the processor cores
- **1** Active one of the processor cores

→ Intel Virtualization Technology [Disabled]

Use the **Intel Virtualization Technology** option to enable or disable virtualization on the system. When combined with third party software, Intel Virtualization technology allows several OSs to run on the same system at the same time.

- **Disabled** **DEFAULT** Disables Intel Virtualization
Technology.
- **Enabled** Enables Intel Virtualization Technology.

→ Intel® SpeedStep™ [Enabled]

Use the **Intel® SpeedStep™** option to enable or disable the Intel® SpeedStep Technology.

- **Disabled** Disables the Intel® SpeedStep Technology.
- **Enabled** **DEFAULT** Enables the Intel® SpeedStep Technology.

TANK-620-ULT3 Embedded System

→ CPU C State [Disabled]

Use the **CPU C State** option to enable or disable CPU C State.

- **Disabled** **DEFAULT** Disables CPU C State.
- **Enabled** Enables CPU C State.

5.3.10 SATA Configuration

Use the **SATA Configuration** menu (**BIOS Menu 18**) to change and/or set the configuration of the SATA devices installed in the system.

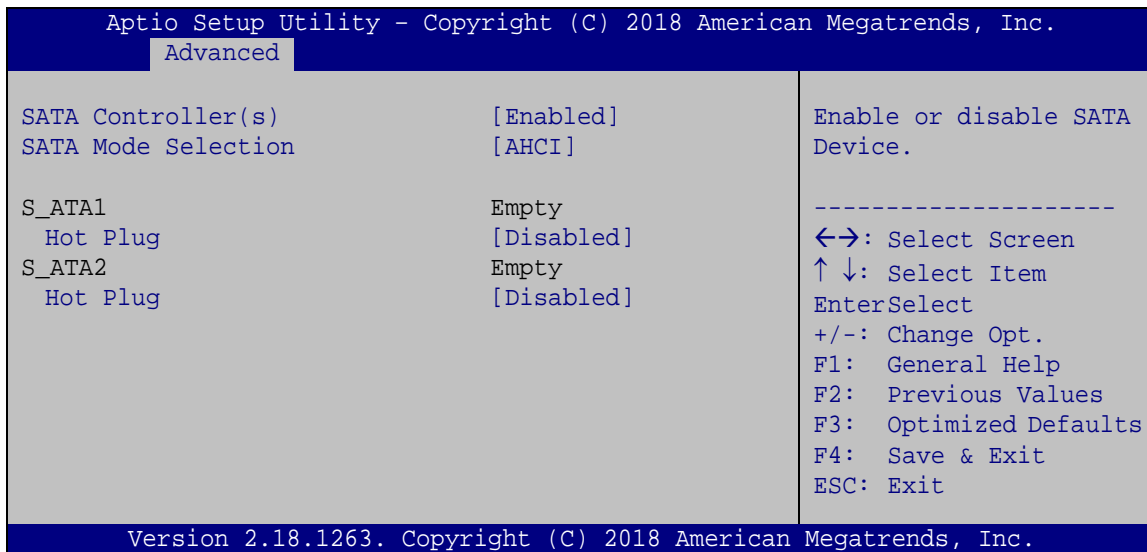

BIOS Menu 18: SATA Configuration

→ SATA Controller(s) [Enabled]

Use the **SATA Controller(s)** option to configure the serial ATA controller.

- **Enabled** **DEFAULT** Enables the on-board SATA controller.
- **Disabled** Disables the on-board SATA controller.

→ SATA Mode Selection [AHCI]

Use the **SATA Selection Mode** option to configure SATA devices.

- ➔ **AHCI** **DEFAULT** Configures SATA devices as AHCI device.
- ➔ **RAID** Configures SATA devices as RAID device.

➔ **Hot Plug [Disabled]**

Use the **Hot Plug** option to enable or disable the hot plug function.

- ➔ **Disabled** **DEFAULT** Disables the hot plug function.
- ➔ **Enabled** Enables the hot plug function.

5.3.11 USB Configuration

Use the **USB Configuration** menu (**BIOS Menu 19**) to read USB configuration information and configure the USB settings.

```

Aptio Setup Utility - Copyright (C) 2018 American Megatrends, Inc.
  Advanced
-----
USB Configuration
USB Devices:
  1 Keyboard
Legacy USB Support                [Enabled]
-----
                                  Enables Legacy USB
                                  support. AUTO option
                                  disables legacy support
                                  if no USB devices are
                                  connected. DISABLE
                                  option will keep USB
                                  devices available only
                                  for EFI applications.
-----
                                  -----
                                  ←→: Select Screen
                                  ↑↓: Select Item
                                  Enter>Select
                                  +/-: Change Opt.
                                  F1:  General Help
                                  F2:  Previous Values
                                  F3:  Optimized Defaults
                                  F4:  Save & Exit
                                  ESC: Exit
-----
Version 2.18.1263. Copyright (C) 2018 American Megatrends, Inc.
  
```

BIOS Menu 19: USB Configuration

➔ **USB Devices**

The **USB Devices** field lists the USB devices that are enabled on the system

TANK-620-ULT3 Embedded System

→ Legacy USB Support [Enabled]

Use the **Legacy USB Support** BIOS option to enable USB mouse and USB keyboard support. Normally if this option is not enabled, any attached USB mouse or USB keyboard does not become available until a USB compatible operating system is fully booted with all USB drivers loaded. When this option is enabled, any attached USB mouse or USB keyboard can control the system even when there is no USB driver loaded onto the system.

- **Enabled** **DEFAULT** Legacy USB support enabled
- **Disabled** Legacy USB support disabled
- **Auto** Legacy USB support disabled if no USB devices are connected

5.3.12 iEi Feature

Use the **iEi Feature** menu (**BIOS Menu 20**) to configure the iEi features.

```
Aptio Setup Utility - Copyright (C) 2018 American Megatrends, Inc.
  Advanced
iEi Feature
Auto Recovery Function      [Disabled]
Auto Recovery Function      Auto Recovery Function
                            Reboot and recover
                            system automatically
                            within 10 min, when OS
                            crashes. Please install
                            Auto Recovery API
                            service before enabling
                            this function.

-----
<->: Select Screen
↑ ↓: Select Item
Enter>Select
+/-: Change Opt.
F1: General Help
F2: Previous Values
F3: Optimized Defaults
F4: Save & Exit
ESC: Exit

Version 2.18.1263. Copyright (C) 2018 American Megatrends, Inc.
```

BIOS Menu 20: iEi Feature

➔ **Auto Recovery Function [Disabled]**

Use **Auto Recovery Function** option to enable or disable the auto recovery function.

- ➔ **Disabled** **DEFAULT** Disabled the auto recovery function
- ➔ **Enabled** Enabled the auto recovery function

5.4 Chipset

Use the **Chipset** menu (**BIOS Menu 21**) to access the PCH-IO and System Agent (SA) configuration menus.



WARNING!

Setting the wrong values for the Chipset BIOS selections in the Chipset BIOS menu may cause the system to malfunction.

```

Aptio Setup Utility - Copyright (C) 2018 American Megatrends, Inc.
  Chipset
-----
> System Agent (SA) Configuration
> PCH-IO Configuration

System Agent (SA)
Parameters
-----
<->: Select Screen
↑ ↓: Select Item
EnterSelect
+/-: Change Opt.
F1:  General Help
F2:  Previous Values
F3:  Optimized Defaults
F4:  Save & Exit
ESC: Exit

Version 2.18.1263. Copyright (C) 2018 American Megatrends, Inc.
  
```

BIOS Menu 21: Chipset

TANK-620-ULT3 Embedded System

5.4.1 System Agent (SA) Configuration

Use the **System Agent (SA) Configuration** menu (**BIOS Menu 22**) to configure the System Agent (SA) parameters.

```

Aptio Setup Utility - Copyright (C) 2018 American Megatrends, Inc.
Chipset
VT-d [Disabled] VT-d capability
> Graphics Configuration
> Memory Configuration
-----
-><: Select Screen
↑↓: Select Item
Enter: Select
+/-: Change Opt.
F1: General Help
F2: Previous Values
F3: Optimized Defaults
F4: Save & Exit
ESC: Exit
Version 2.18.1263. Copyright (C) 2018 American Megatrends, Inc.
  
```

BIOS Menu 22: System Agent (SA) Configuration

→ VT-d [Disabled]

Use the **VT-d** option to enable or disable VT-d support.

- **Disabled** **DEFAULT** Disable VT-d support.
- **Enabled** Enable VT-d support.

5.4.1.1 Graphics Configuration

Use the **Graphics Configuration** (**BIOS Menu 23**) menu to configure the video device connected to the system.

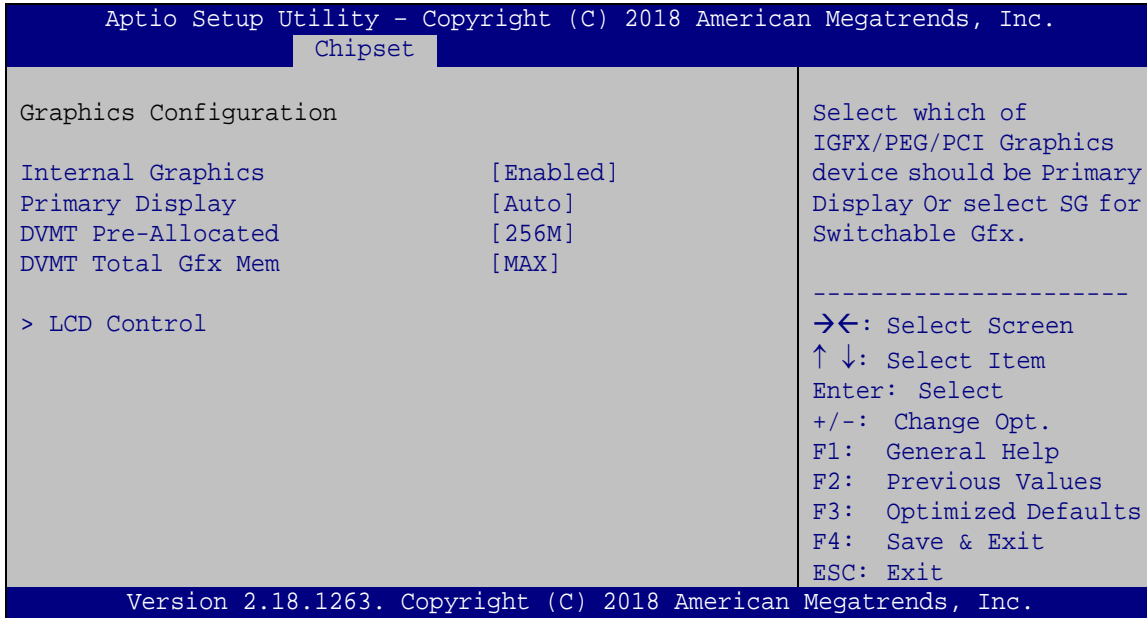

BIOS Menu 23: Graphics Configuration

→ Internal Graphics [Enabled]

Use the **Internal Graphics** option to enable or disable the internal graphics device.

- **Auto** The internal graphics device is automatically detected and enabled.
- **Disabled** Disable the internal graphics device.
- **Enabled** **DEFAULT** Enable the internal graphics device. The following options/submenu appear with values that can be selected:
 - DVMT Pre-Allocated
 - DVMT Total Gfx Mem
 - LCD Control

→ Primary Display [Auto]

Use the **Primary Display** option to select the display device used by the system when it boots. Configuration options are listed below.

- Auto **DEFAULT**

TANK-620-ULT3 Embedded System

- IGFX
- PCIE

→ DVMT Pre-Allocated [256M]

Use the **DVMT Pre-Allocated** option to set the amount of system memory allocated to the integrated graphics processor when the system boots. The system memory allocated can then only be used as graphics memory, and is no longer available to applications or the operating system. Configuration options are listed below:

- 32M
- 64M
- 128M
- 256M **Default**
- 512M

→ DVMT Total Gfx Mem [MAX]

Use the **DVMT Total Gfx Mem** option to select DVMT5.0 total graphic memory size used by the internal graphic device. The following options are available:

- 256M
- 128M
- MAX **Default**

5.4.1.1.1 LCD Control

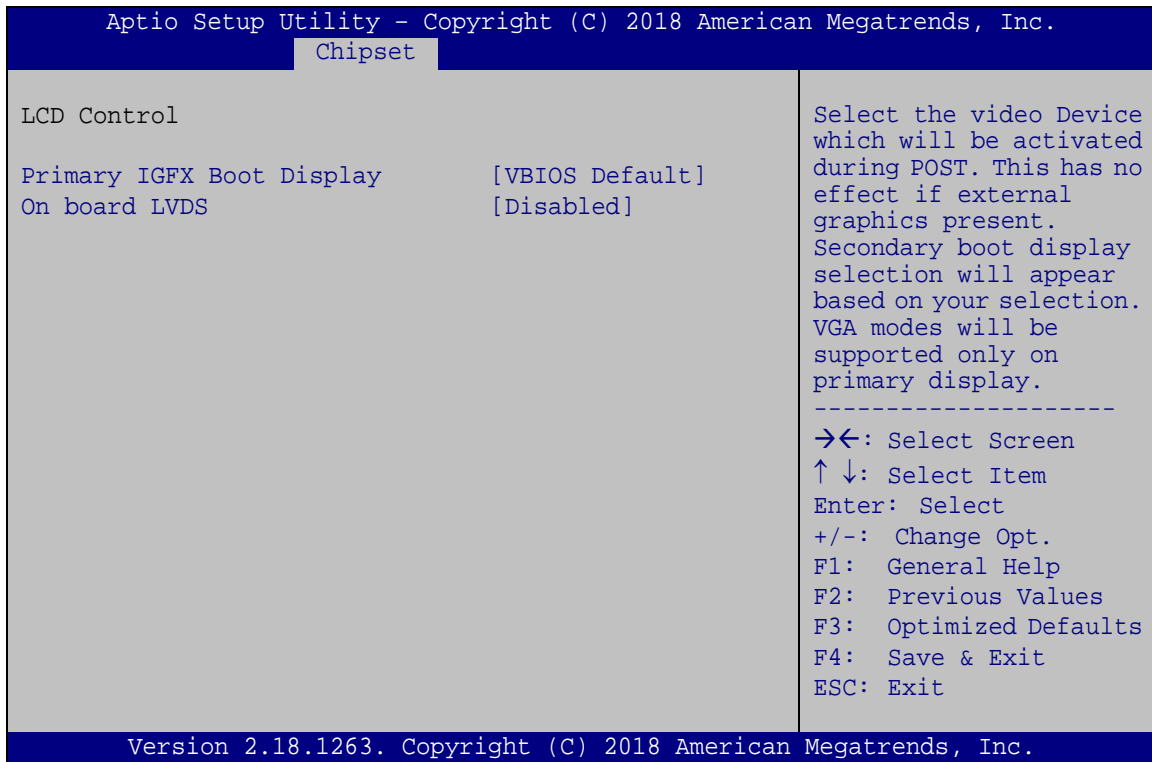

BIOS Menu 24: LCD Control

→ Primary IGFX Boot Display [VBIOS Default]

Use the **Primary IGFX Boot Display** option to select the display device used by the system when it boots. Configuration options are listed below.

- VBIOS Default **DEFAULT**
- CRT1
- CRT2
- CRT3/LVDS

→ On board LVDS [Disabled]

Use the **On board LVDS** option enables or disables the on-board LVDS connector.

- **Disabled** **DEFAULT** The on-board LVDS connector is disabled.
- **Enabled** The on-board LVDS connector is disabled.

TANK-620-ULT3 Embedded System



NOTE:

The following option will be available to configure only when the **On board LVDS** option is set to **Enabled**.

→ Backlight Control [LED]

Use the **Backlight Control** BIOS option to select the LCD backlight control type. Configuration options are listed below.

- LED **DEFAULT**
- CCFL

5.4.1.2 Memory Configuration

Use the **Memory Configuration** submenu (**BIOS Menu 25**) to view memory information.

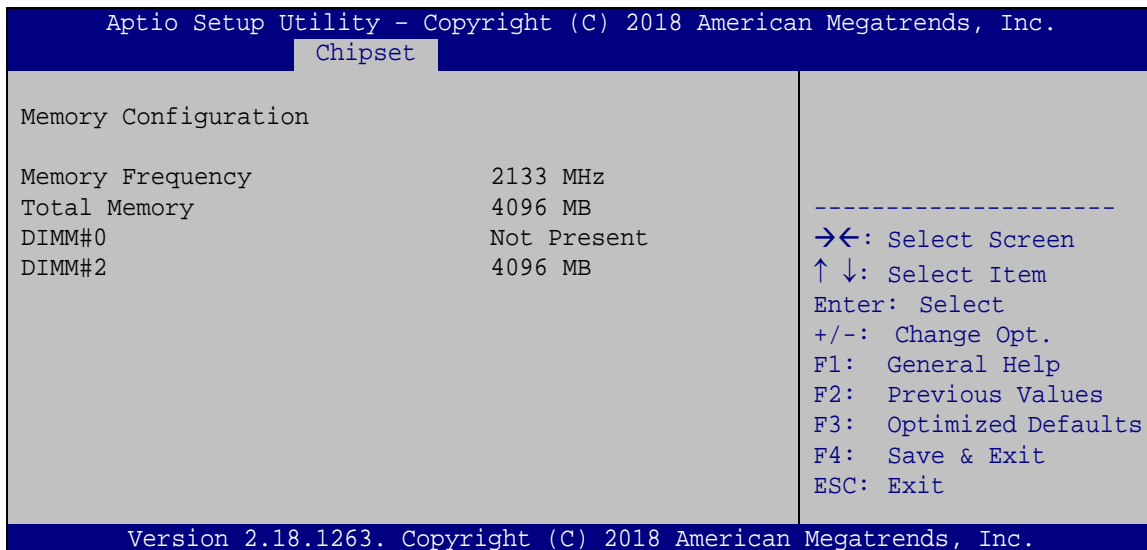

BIOS Menu 25: Memory Configuration

5.4.2 PCH-IO Configuration

Use the **PCH-IO Configuration** menu (**BIOS Menu 26**) to configure the PCH parameters.

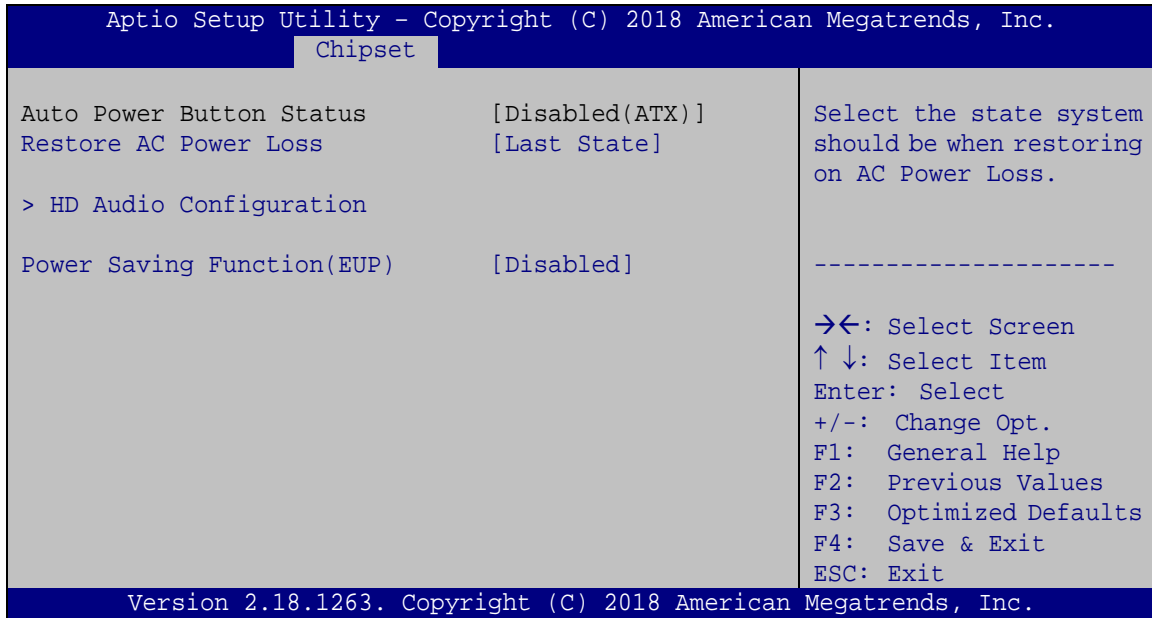

BIOS Menu 26: PCH-IO Configuration

→ Restore AC Power Loss [Last State]

Use the **Restore on AC Power Loss** option to specify what state the system returns to if there is a sudden loss of power to the system.

- **Power Off** The system remains turned off
- **Power On** The system turns on
- **Last State** **DEFAULT** The system returns to its previous state. If it was on, it turns itself on. If it was off, it remains off.

→ Power Saving Function (ERP) [Disabled]

Use the **Power Saving Function (ERP)** BIOS option to enable or disable the power saving function.

- **Disabled** **DEFAULT** Power saving function is disabled.

TANK-620-ULT3 Embedded System

- ➔ **Enabled** Power saving function is enabled. It will reduce power consumption when the system is off.

5.4.2.1 HD Audio Configuration

Use the **HD Audio Configuration** menu (**BIOS Menu 27**) to configure the HD Audio settings.

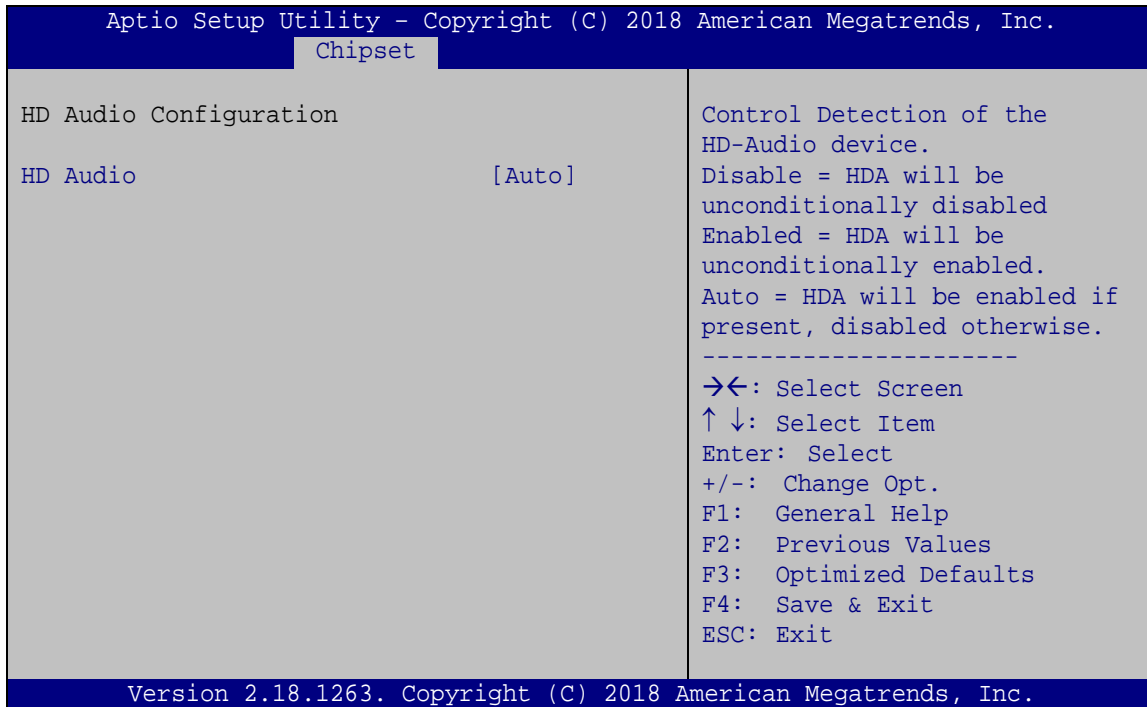

BIOS Menu 27: PCH Azalia Configuration

➔ **HD Audio [Auto]**

Use the **HD Audio** option to enable or disable the High Definition Audio controller.

- ➔ **Disabled** The onboard High Definition Audio controller is disabled
- ➔ **Enabled** The onboard High Definition Audio controller is enabled
- ➔ **Auto** **DEFAULT** The onboard High Definition Audio controller automatically detected and enabled

5.5 Security

Use the **Security** menu (**BIOS Menu 28**) to set system and user passwords.

```

Aptio Setup Utility - Copyright (C) 2018 American Megatrends, Inc.
Security
-----
Password Description
If ONLY the Administrator's password is set,
then this only limits access to Setup and is
only asked for when entering Setup.
If ONLY the User's password is set, then this
is a power on password and must be entered to
boot or enter Setup. In Setup the User will
have Administrator rights.
The password length must be:
Minimum length          3
Maximum length          20

Administrator Password
User Password

Set Administrator
Password

-----
<->: Select Screen
↑ ↓: Select Item
Enter>Select
+/-: Change Opt.
F1:  General Help
F2:  Previous Values
F3:  Optimized Defaults
F4:  Save & Exit
ESC: Exit

Version 2.18.1263. Copyright (C) 2018 American Megatrends, Inc.
    
```

BIOS Menu 28: Security

➔ **Administrator Password**

Use the **Administrator Password** to set or change an administrator password.

➔ **User Password**

Use the **User Password** to set or change a user password.

TANK-620-ULT3 Embedded System

5.6 Boot

Use the **Boot** menu (**BIOS Menu 29**) to configure system boot options.

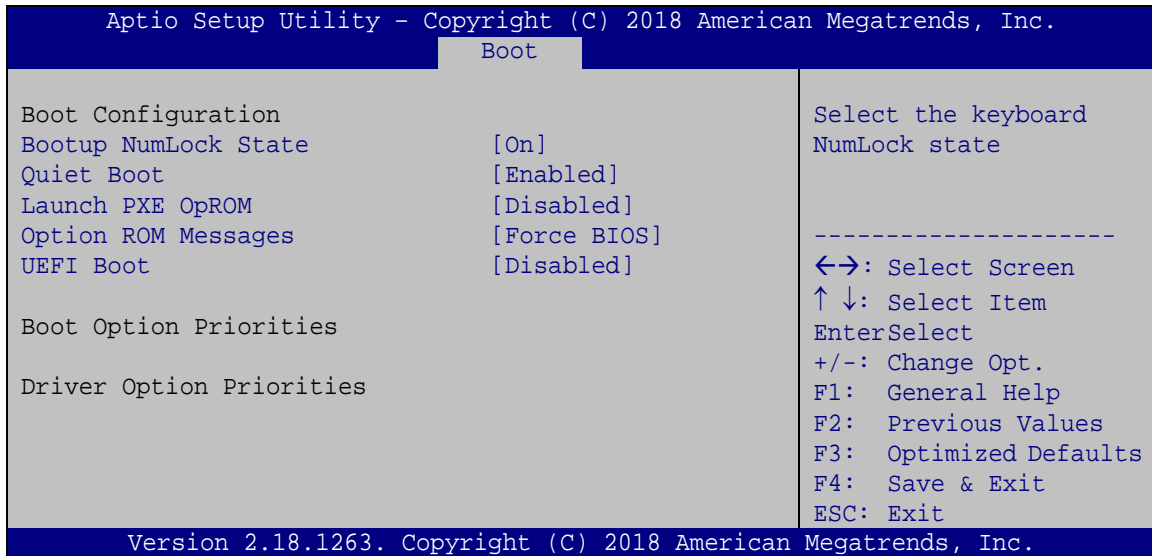

BIOS Menu 29: Boot

→ Bootup NumLock State [On]

Use the **Bootup NumLock State** BIOS option to specify if the number lock setting must be modified during boot up.

→ **On** **DEFAULT** Allows the Number Lock on the keyboard to be enabled automatically when the computer system boots up. This allows the immediate use of the 10-key numeric keypad located on the right side of the keyboard. To confirm this, the Number Lock LED light on the keyboard is lit.

→ **Off** Does not enable the keyboard Number Lock automatically. To use the 10-keys on the keyboard, press the Number Lock key located on the upper left-hand corner of the 10-key pad. The Number Lock LED on the keyboard lights up when the Number Lock is engaged.

→ Quiet Boot [Enabled]

Use the **Quiet Boot** BIOS option to select the screen display when the system boots.

- **Disabled** Normal POST messages displayed
- **Enabled** **DEFAULT** OEM Logo displayed instead of POST messages

→ Launch PXE OpROM [Disabled]

Use the **Launch PXE OpROM** option to enable or disable boot option for legacy network devices.

- **Disabled** **DEFAULT** Ignore all PXE Option ROMs.
- **Enabled** Load PXE Option ROMs.

→ Option ROM Messages [Force BIOS]

Use the **Option ROM Messages** option to set the Option ROM display mode.

- **Force BIOS** **DEFAULT** Sets display mode to force BIOS.
- **Keep Current** Sets display mode to current.

→ UEFI Boot [Disabled]

Use the **UEFI Boot** option to enable or disable to boot from the UEFI devices.

- **Enabled** Boot from UEFI devices is enabled.
- **Disabled** **DEFAULT** Boot from UEFI devices is disabled.

→ Boot Option Priority

Use the **Boot Option Priority** function to set the system boot sequence from the available devices. The drive sequence also depends on the boot sequence in the individual device section.

TANK-620-ULT3 Embedded System

5.7 Save & Exit

Use the **Save & Exit** menu (**BIOS Menu 30**) to load default BIOS values, optimal failsafe values and to save configuration changes.

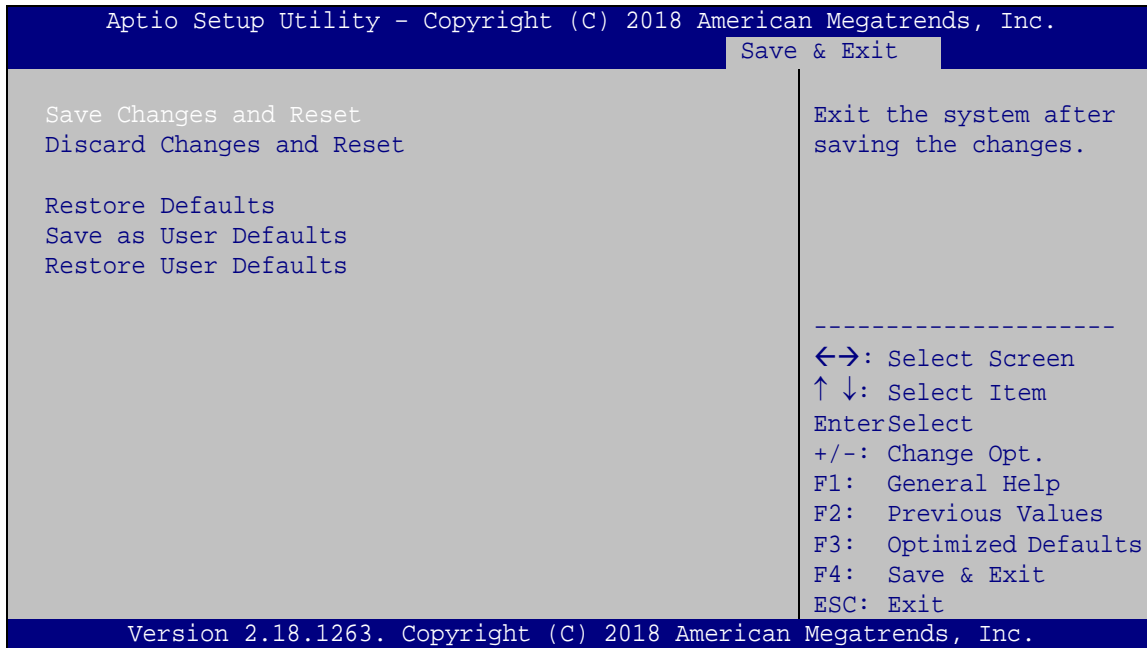

BIOS Menu 30:Exit

→ Save Changes and Reset

Use the **Save Changes and Reset** option to save the changes made to the BIOS options and reset the system.

→ Discard Changes and Reset

Use the **Discard Changes and Reset** option to exit the system without saving the changes made to the BIOS configuration setup program.

→ Restore Defaults

Use the **Restore Defaults** option to load the optimal default values for each of the parameters on the Setup menus. **F3 key can be used for this operation.**

→ **Save as User Defaults**

Use the **Save as User Defaults** option to save the changes done so far as user defaults.

→ **Restore User Defaults**

Use the **Restore User Defaults** option to restore the user defaults to all the setup options.

Appendix

A

Regulatory Compliance

DECLARATION OF CONFORMITY

This equipment is in conformity with the following EU directives:

- EMC Directive (2004/108/EC, 2014/30/EU)
- Low-Voltage Directive (2006/95/EC, 2014/35/EU)
- RoHS II Directive (2011/65/EU, 2015/863/EU)

If the user modifies and/or install other devices in the equipment, the CE conformity declaration may no longer apply.

If this equipment has telecommunications functionality, it also complies with the requirements of the Radio Equipment Directive 2014/53/EU.

English

IEI Integration Corp declares that this equipment is in compliance with the essential requirements and other relevant provisions of Directive 2014/53/EU.

Български [Bulgarian]

IEI Integration Corp. декларира, че този оборудване е в съответствие със съществените изисквания и другите приложими правила на Директива 2014/53/EU.

Česky [Czech]

IEI Integration Corp tímto prohlašuje, že tento zařizení je ve shodě se základními požadavky a dalšími příslušnými ustanoveními směrnice 2014/53/EU.

Dansk [Danish]

IEI Integration Corp erklærer herved, at følgende udstyr overholder de væsentlige krav og øvrige relevante krav i direktiv 2014/53/EU.

Deutsch [German]

IEI Integration Corp, erklärt dieses Gerät entspricht den grundlegenden Anforderungen und den weiteren entsprechenden Vorgaben der Richtlinie 2014/53/EU.

TANK-620-ULT3 Embedded System

Eesti [Estonian]

IEI Integration Corp deklareerib seadme seadme vastavust direktiivi 2014/53/EÜ põhinõuetele ja nimetatud direktiivist tulenevatele teistele asjakohastele sätetele.

Español [Spanish]

IEI Integration Corp declara que el equipo cumple con los requisitos esenciales y cualesquiera otras disposiciones aplicables o exigibles de la Directiva 2014/53/EU.

Ελληνική [Greek]

IEI Integration Corp ΔΗΛΩΝΕΙ ΟΤΙ ΕΞΟΠΛΙΣΜΟΣ ΣΥΜΜΟΡΦΩΝΕΤΑΙ ΠΡΟΣ ΤΙΣ ΟΥΣΙΩΔΕΙΣ ΑΠΑΙΤΗΣΕΙΣ ΚΑΙ ΤΙΣ ΛΟΙΠΕΣ ΣΧΕΤΙΚΕΣ ΔΙΑΤΑΞΕΙΣ ΤΗΣ ΟΔΗΓΙΑΣ 2014/53/EU.

Français [French]

IEI Integration Corp déclare que l'appareil est conforme aux exigences essentielles et aux autres dispositions pertinentes de la directive 2014/53/EU.

Italiano [Italian]

IEI Integration Corp dichiara che questo apparecchio è conforme ai requisiti essenziali ed alle altre disposizioni pertinenti stabilite dalla direttiva 2014/53/EU.

Latviski [Latvian]

IEI Integration Corp deklarē, ka iekārta atbilst būtiskajām prasībām un citiem ar to saistītajiem noteikumiem Direktīvas 2014/53/EU.

Lietuvių [Lithuanian]

IEI Integration Corp deklaruoja, kad šis įranga atitinka esminius reikalavimus ir kitas 2014/53/EU Direktyvos nuostatas.

Nederlands [Dutch]

IEI Integration Corp dat het toestel toestel in overeenstemming is met de essentiële eisen en de andere relevante bepalingen van richtlijn 2014/53/EU.

Malti [Maltese]

IEI Integration Corp jiddikjara li dan prodott jikkonforma mal-ħtiġijiet essenzjali u ma provvedimenti oħrajn relevanti li hemm fid-Dirrettiva 2014/53/EU.

Magyar [Hungarian]

IEI Integration Corp nyilatkozom, hogy a berendezés megfelel a vonatkozó alapvető követelményeknek és az 2014/53/EU irányelv egyéb előírásainak.

Polski [Polish]

IEI Integration Corp oświadcza, że wyrobu jest zgodny z zasadniczymi wymogami oraz pozostałymi stosownymi postanowieniami Dyrektywy 2014/53/EU.

Português [Portuguese]

IEI Integration Corp declara que este equipamento está conforme com os requisitos essenciais e outras disposições da Directiva 2014/53/EU.

Româna [Romanian]

IEI Integration Corp declară că acest echipament este în conformitate cu cerințele esențiale și cu celelalte prevederi relevante ale Directivei 2014/53/EU.

Slovensko [Slovenian]

IEI Integration Corp izjavlja, da je ta opreme v skladu z bistvenimi zahtevami in ostalimi relevantnimi določili direktive 2014/53/EU.

Slovensky [Slovak]

IEI Integration Corp týmto vyhlasuje, že zariadenia spĺňa základné požiadavky a všetky príslušné ustanovenia Smernice 2014/53/EU.

Suomi [Finnish]

IEI Integration Corp vakuuttaa täten että laitteet on direktiivin 2014/53/EU oleellisten vaatimusten ja sitä koskevien direktiivin muiden ehtojen mukainen.

Svenska [Swedish]

IEI Integration Corp förklarar att denna utrustningstyp står i överensstämmelse med de väsentliga egenskapskrav och övriga relevanta bestämmelser som framgår av direktiv 2014/53/EU.



FCC WARNING

This equipment complies with Part 15 of the FCC Rules. Operation is subject to the following two conditions:

- This device may not cause harmful interference, and
- This device must accept any interference received, including interference that may cause undesired operation.

This equipment has been tested and found to comply with the limits for a Class A digital device, pursuant to part 15 of the FCC Rules. These limits are designed to provide reasonable protection against harmful interference when the equipment is operated in a commercial environment. This equipment generates, uses, and can radiate radio frequency energy and, if not installed and used in accordance with the instruction manual, may cause harmful interference to radio communications. Operation of this equipment in a residential area is likely to cause harmful interference in which case the user will be required to correct the interference at his own expense.

Federal Communication Commission Interference Statement

This equipment has been assembled with components that comply with the limits for a Class B digital device, pursuant to Part 15 of the FCC Rules. These limits are designed to provide reasonable protection against harmful interference in a residential installation. This equipment generates, uses and can radiate radio frequency energy and, if not installed and used in accordance with the instructions, may cause harmful interference to radio communications. However, there is no guarantee that interference will not occur in a particular installation. If this equipment does cause harmful interference to radio or television reception, which can be determined by turning the equipment off and on, the user is encouraged to try to correct the interference by one of the following measures:

- Reorient or relocate the receiving antenna.
- Increase the separation between the equipment and receiver.
- Connect the equipment into an outlet on a circuit different from that to which the receiver is connected.
- Consult the dealer or an experienced radio/TV technician for help.

Appendix

B

BIOS Options

TANK-620-ULT3 Embedded System

Below is a list of BIOS configuration options in the BIOS chapter.

➔ System Date [xx/xx/xx]	41
➔ System Time [xx:xx:xx]	41
➔ Security Device Support [Disable]	43
➔ ACPI Sleep State [S3 (Suspend to RAM)]	43
➔ Serial Port [Enabled]	45
➔ Device Settings [IO=3E8h; IRQ=4]	45
➔ Serial Port [Enabled]	45
➔ Device Settings [IO=2F8h; IRQ=3]	45
➔ Serial Port [Enabled]	46
➔ Device Settings [IO=2C0h; IRQ=10]	46
➔ Serial Port [Enabled]	46
➔ Device Settings [IO=2C8h; IRQ=10]	46
➔ Serial Port [Enabled]	47
➔ Device Settings [IO=2D0h; IRQ=10]	47
➔ Device Mode [RS232]	47
➔ Serial Port [Enabled]	47
➔ Device Settings [IO=2D8h; IRQ=10]	48
➔ Device Mode [RS232]	48
➔ Parallel Port [Enabled]	48
➔ Change Settings [IO=378h; IRQ=7]	49
➔ Device Mode [STD Printer Mode]	49
➔ PC Health Status	50
➔ Tcc Activation Offset	51
➔ F81866 Smart Fan Function [Enabled]	51
➔ FAN1 Smart Fan Control [Auto Duty-Cycle Mode]	52
➔ CPU Temperature n	52
➔ Serial Port [Enabled]	53
➔ Device Settings [IO=240h; IRQ=11]	53
➔ Device Mode [RS232]	54
➔ Serial Port [Enabled]	54
➔ Device Settings [IO=248h; IRQ=11]	54
➔ Device Mode [RS232]	54
➔ Serial Port [Enabled]	55

➔ Device Settings [IO=250h; IRQ=11]	55
➔ Device Mode [RS232].....	55
➔ Serial Port [Enabled].....	55
➔ Device Settings [IO=258h; IRQ=11]	56
➔ Device Mode [RS232].....	56
➔ Serial Port [Enabled].....	56
➔ Device Settings [IO=260h; IRQ=11]	56
➔ Device Mode [RS232].....	56
➔ Serial Port [Enabled].....	57
➔ Device Settings [IO=268h; IRQ=11]	57
➔ Device Mode [RS232].....	57
➔ Serial Port [Enabled].....	59
➔ Device Settings [IO=288h; IRQ=6]	59
➔ Serial Port [Enabled].....	59
➔ Device Settings [IO=2E8h; IRQ=6]	59
➔ Wake System with Fixed Time [Disabled]	60
➔ Console Redirection [Disabled]	62
➔ Terminal Type [ANSI].....	62
➔ Bits per second [115200].....	63
➔ Data Bits [8]	63
➔ Parity [None].....	63
➔ Stop Bits [1].....	64
➔ Active Processor Cores [All]	66
➔ Intel Virtualization Technology [Disabled]	66
➔ Intel® SpeedStep™ [Enabled]	66
➔ CPU C State [Disabled].....	67
➔ SATA Controller(s) [Enabled]	67
➔ SATA Mode Selection [AHCI].....	67
➔ Hot Plug [Disabled].....	68
➔ USB Devices	68
➔ Legacy USB Support [Enabled].....	69
➔ Auto Recovery Function [Disabled].....	70
➔ VT-d [Disabled].....	71
➔ Internal Graphics [Enabled].....	72
➔ Primary Display [Auto]	72

TANK-620-ULT3 Embedded System

➔ DVMT Pre-Allocated [256M]	73
➔ DVMT Total Gfx Mem [MAX].....	73
➔ Primary IGFX Boot Display [VBIOS Default]	74
➔ On board LVDS [Disabled].....	74
➔ Backlight Control [LED]	75
➔ Restore AC Power Loss [Last State]	76
➔ Power Saving Function (ERP) [Disabled].....	76
➔ HD Audio [Auto].....	77
➔ Administrator Password	78
➔ User Password	78
➔ Bootup NumLock State [On].....	79
➔ Quiet Boot [Enabled]	80
➔ Launch PXE OpROM [Disabled]	80
➔ Option ROM Messages [Force BIOS].....	80
➔ UEFI Boot [Disabled]	80
➔ Boot Option Priority.....	80
➔ Save Changes and Reset	81
➔ Discard Changes and Reset	81
➔ Restore Defaults	81
➔ Save as User Defaults	82
➔ Restore User Defaults	82

Appendix

C

Terminology

TANK-620-ULT3 Embedded System

AC '97	Audio Codec 97 (AC'97) refers to a codec standard developed by Intel® in 1997.
ACPI	Advanced Configuration and Power Interface (ACPI) is an OS-directed configuration, power management, and thermal management interface.
AHCI	Advanced Host Controller Interface (AHCI) is a SATA Host controller register-level interface.
ATA	The Advanced Technology Attachment (ATA) interface connects storage devices including hard disks and CD-ROM drives to a computer.
ARMD	An ATAPI Removable Media Device (ARMD) is any ATAPI device that supports removable media, besides CD and DVD drives.
ASKIR	Amplitude Shift Keyed Infrared (ASKIR) is a form of modulation that represents a digital signal by varying the amplitude (“volume”) of the signal. A low amplitude signal represents a binary 0, while a high amplitude signal represents a binary 1.
BIOS	The Basic Input/Output System (BIOS) is firmware that is first run when the computer is turned on and can be configured by the end user
CODEC	The Compressor-Decompressor (CODEC) encodes and decodes digital audio data on the system.
CompactFlash®	CompactFlash® is a solid-state storage device. CompactFlash® devices use flash memory in a standard size enclosure. Type II is thicker than Type I, but a Type II slot can support both types.
CMOS	Complimentary metal-oxide-conductor is an integrated circuit used in chips like static RAM and microprocessors.
COM	COM refers to serial ports. Serial ports offer serial communication to expansion devices. The serial port on a personal computer is usually a male D-sub 9 connector.
DAC	The Digital-to-Analog Converter (DAC) converts digital signals to analog signals.
DDR	Double Data Rate refers to a data bus transferring data on both the rising and falling edges of the clock signal.

DMA	Direct Memory Access (DMA) enables some peripheral devices to bypass the system processor and communicate directly with the system memory.
DIMM	Dual Inline Memory Modules are a type of RAM that offer a 64-bit data bus and have separate electrical contacts on each side of the module.
DIO	The digital inputs and digital outputs are general control signals that control the on/off circuit of external devices or TTL devices. Data can be read or written to the selected address to enable the DIO functions.
EHCI	The Enhanced Host Controller Interface (EHCI) specification is a register-level interface description for USB 2.0 Host Controllers.
EIDE	Enhanced IDE (EIDE) is a newer IDE interface standard that has data transfer rates between 4.0 MBps and 16.6 MBps.
EIST	Enhanced Intel® SpeedStep Technology (EIST) allows users to modify the power consumption levels and processor performance through application software. The application software changes the bus-to-core frequency ratio and the processor core voltage.
FSB	The Front Side Bus (FSB) is the bi-directional communication channel between the processor and the Northbridge chipset.
GbE	Gigabit Ethernet (GbE) is an Ethernet version that transfers data at 1.0 Gbps and complies with the IEEE 802.3-2005 standard.
GPIO	General purpose input
HDD	Hard disk drive (HDD) is a type of magnetic, non-volatile computer storage device that stores digitally encoded data.
ICH	The Input/Output Control Hub (ICH) is an Intel® Southbridge chipset.
IrDA	Infrared Data Association (IrDA) specify infrared data transmission protocols used to enable electronic devices to wirelessly communicate with each other.
L1 Cache	The Level 1 Cache (L1 Cache) is a small memory cache built into the system processor.
L2 Cache	The Level 2 Cache (L2 Cache) is an external processor memory cache.

TANK-620-ULT3 Embedded System

LCD	Liquid crystal display (LCD) is a flat, low-power display device that consists of two polarizing plates with a liquid crystal panel in between.
LVDS	Low-voltage differential signaling (LVDS) is a dual-wire, high-speed differential electrical signaling system commonly used to connect LCD displays to a computer.
POST	The Power-on Self Test (POST) is the pre-boot actions the system performs when the system is turned-on.
RAM	Random Access Memory (RAM) is volatile memory that loses data when power is lost. RAM has very fast data transfer rates compared to other storage like hard drives.
SATA	Serial ATA (SATA) is a serial communications bus designed for data transfers between storage devices and the computer chipsets. The SATA bus has transfer speeds up to 1.5 Gbps and the SATA II bus has data transfer speeds of up to 3.0 Gbps.
S.M.A.R.T	Self Monitoring Analysis and Reporting Technology (S.M.A.R.T) refers to automatic status checking technology implemented on hard disk drives.
UART	Universal Asynchronous Receiver-transmitter (UART) is responsible for asynchronous communications on the system and manages the system's serial communication (COM) ports.
UHCI	The Universal Host Controller Interface (UHCI) specification is a register-level interface description for USB 1.1 Host Controllers.
USB	The Universal Serial Bus (USB) is an external bus standard for interfacing devices. USB 1.1 supports 12Mbps data transfer rates and USB 2.0 supports 480Mbps data transfer rates.
VGA	The Video Graphics Array (VGA) is a graphics display system developed by IBM.

Appendix

D

Safety Precautions

TANK-620-ULT3 Embedded System

D.1 Safety Precautions



WARNING:

The precautions outlined in this appendix should be strictly followed. Failure to follow these precautions may result in permanent damage to the TANK-620-ULT3.

Please follow the safety precautions outlined in the sections that follow:

D.1.1 General Safety Precautions

Please ensure the following safety precautions are adhered to at all times.

- ***Make sure the power is turned off and the power cord is disconnected*** when moving, installing or modifying the system.
- ***Do not apply voltage levels that exceed the specified voltage range.*** Doing so may cause fire and/or an electrical shock.
- ***Electric shocks can occur*** if opened while still powered on.
- ***Do not drop or insert any objects*** into the ventilation openings.
- ***If considerable amounts of dust, water, or fluids enter the system***, turn off the power supply immediately, unplug the power cord, and contact the system vendor.
- **DO NOT:**
 - Drop the system against a hard surface.
 - In a site where the ambient temperature exceeds the rated temperature

D.1.2 Anti-static Precautions

**WARNING:**

Failure to take ESD precautions during the installation of the TANK-620-ULT3 may result in permanent damage to the TANK-620-ULT3 and severe injury to the user.

Electrostatic discharge (ESD) can cause serious damage to electronic components, including the TANK-620-ULT3. Dry climates are especially susceptible to ESD. It is therefore critical that whenever the TANK-620-ULT3 is opened and any of the electrical components are handled, the following anti-static precautions are strictly adhered to.

- ***Wear an anti-static wristband:*** Wearing a simple anti-static wristband can help to prevent ESD from damaging any electrical component.
- ***Self-grounding:*** Before handling any electrical component, touch any grounded conducting material. During the time the electrical component is handled, frequently touch any conducting materials that are connected to the ground.
- ***Use an anti-static pad:*** When configuring or working with an electrical component, place it on an anti-static pad. This reduces the possibility of ESD damage.
- ***Only handle the edges of the electrical component:*** When handling the electrical component, hold the electrical component by its edges.

TANK-620-ULT3 Embedded System

D.1.3 Product Disposal



CAUTION:

Risk of explosion if battery is replaced by and incorrect type. Only certified engineers should replace the on-board battery.

Dispose of used batteries according to instructions and local regulations.

- Outside the European Union – If you wish to dispose of used electrical and electronic products outside the European Union, please contact your local authority so as to comply with the correct disposal method.
- Within the European Union – The device that produces less waste and is easier to recycle is classified as electronic device in terms of the European Directive 2012/19/EU (WEEE), and must not be disposed of as domestic garbage.

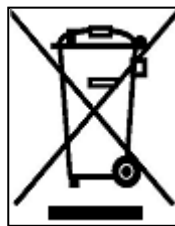

EU-wide legislation, as implemented in each Member State, requires that waste electrical and electronic products carrying the mark (left) must be disposed of separately from normal household waste. This includes monitors and electrical accessories, such as signal cables or power cords.

When you need to dispose of your display products, please follow the guidance of your local authority, or ask the shop where you purchased the product. The mark on electrical and electronic products only applies to the current European Union Member States.

Please follow the national guidelines for electrical and electronic product disposal.

D.2 Maintenance and Cleaning Precautions

When maintaining or cleaning the TANK-620-ULT3, please follow the guidelines below.

D.2.1 Maintenance and Cleaning

Prior to cleaning any part or component of the TANK-620-ULT3, please read the details below.

- The interior of the TANK-620-ULT3 does not require cleaning. Keep fluids away from the TANK-620-ULT3 interior.
- Be cautious of all small removable components when vacuuming the TANK-620-ULT3.
- Turn the TANK-620-ULT3 off before cleaning the TANK-620-ULT3.
- Never drop any objects or liquids through the openings of the TANK-620-ULT3.
- Be cautious of any possible allergic reactions to solvents or chemicals used when cleaning the TANK-620-ULT3.
- Avoid eating, drinking and smoking within vicinity of the TANK-620-ULT3.

D.2.2 Cleaning Tools

Some components in the TANK-620-ULT3 may only be cleaned using a product specifically designed for the purpose. In such case, the product will be explicitly mentioned in the cleaning tips. Below is a list of items to use when cleaning the TANK-620-ULT3.

- **Cloth** – Although paper towels or tissues can be used, a soft, clean piece of cloth is recommended when cleaning the TANK-620-ULT3.
- **Water or rubbing alcohol** – A cloth moistened with water or rubbing alcohol can be used to clean the TANK-620-ULT3.
- **Using solvents** – The use of solvents is not recommended when cleaning the TANK-620-ULT3 as they may damage the plastic parts.
- **Vacuum cleaner** – Using a vacuum specifically designed for computers is one of the best methods of cleaning the TANK-620-ULT3. Dust and dirt can restrict the airflow in the TANK-620-ULT3 and cause its circuitry to corrode.
- **Cotton swabs** - Cotton swabs moistened with rubbing alcohol or water are excellent tools for wiping hard to reach areas.
- **Foam swabs** - Whenever possible, it is best to use lint free swabs such as foam swabs for cleaning.

Appendix

E

Digital I/O Interface

E.1 Introduction

The DIO connector on the TANK-620-ULT3 is interfaced to GPIO ports on the Super I/O chipset. The DIO has both 4-bit digital inputs and 4-bit digital outputs. The digital inputs and digital outputs are generally control signals that control the on/off circuit of external devices or TTL devices. Data can be read or written to the selected address to enable the DIO functions.



NOTE:

For further information, please refer to the datasheet for the Super I/O chipset.

The BIOS interrupt call **INT 15H** controls the digital I/O.

INT 15H:

AH – 6FH
<u>Sub-function:</u>
AL – 8 : Set the digital port as INPUT
AL : Digital I/O input value

TANK-620-ULT3 Embedded System

E.2 Assembly Language Sample 1

```

MOV     AX, 6F08H      ;setting the digital port as input
INT     15H           ;

```

AL low byte = value

AH – 6FH
<u>Sub-function:</u>
AL – 9 : Set the digital port as OUTPUT
BL : Digital I/O input value

E.3 Assembly Language Sample 2

```

MOV     AX, 6F09H      ;setting the digital port as output
MOV     BL, 09H        ;digital value is 09H
INT     15H           ;

```

Digital Output is 1001b

Appendix

F

Hazardous Materials Disclosure

TANK-620-ULT3 Embedded System

The details provided in this appendix are to ensure that the product is compliant with the Peoples Republic of China (China) RoHS standards. The table below acknowledges the presences of small quantities of certain materials in the product, and is applicable to China RoHS only.

A label will be placed on each product to indicate the estimated “Environmentally Friendly Use Period” (EFUP). This is an estimate of the number of years that these substances would “not leak out or undergo abrupt change.” This product may contain replaceable sub-assemblies/components which have a shorter EFUP such as batteries and lamps. These components will be separately marked.

Please refer to the following table.

Part Name	Toxic or Hazardous Substances and Elements					
	Lead (Pb)	Mercury (Hg)	Cadmium (Cd)	Hexavalent Chromium (CR(VI))	Polybrominated Biphenyls (PBB)	Polybrominated Diphenyl Ethers (PBDE)
Housing	O	O	O	O	O	O
Display	O	O	O	O	O	O
Printed Circuit Board	O	O	O	O	O	O
Metal Fasteners	O	O	O	O	O	O
Cable Assembly	O	O	O	O	O	O
Fan Assembly	O	O	O	O	O	O
Power Supply Assemblies	O	O	O	O	O	O
Battery	O	O	O	O	O	O

O: This toxic or hazardous substance is contained in all of the homogeneous materials for the part is below the limit requirement in SJ/T11363-2006 (now replaced by GB/T 26572-2011).

X: This toxic or hazardous substance is contained in at least one of the homogeneous materials for this part is above the limit requirement in SJ/T11363-2006 (now replaced by GB/T 26572-2011).

此附件旨在确保本产品符合中国 RoHS 标准。以下表格标示此产品中某有毒物质的含量符合中国 RoHS 标准规定的限量要求。

本产品上会附有“环境友好使用期限”的标签，此期限是估算这些物质“不会有泄漏或突变”的年限。本产品可能包含有较短的环境友好使用期限的可替换元件，像是电池或灯管，这些元件将会单独标示出来。

部件名称	有毒有害物质或元素					
	铅 (Pb)	汞 (Hg)	镉 (Cd)	六价铬 (CR(VI))	多溴联苯 (PBB)	多溴二苯 醚 (PBDE)
壳体	○	○	○	○	○	○
显示	○	○	○	○	○	○
印刷电路板	○	○	○	○	○	○
金属螺帽	○	○	○	○	○	○
电缆组装	○	○	○	○	○	○
风扇组装	○	○	○	○	○	○
电力供应组装	○	○	○	○	○	○
电池	○	○	○	○	○	○

○: 表示该有毒有害物质在该部件所有物质材料中的含量均在 SJ/T 11363-2006 (现由 GB/T 26572-2011 取代) 标准规定的限量要求以下。

X: 表示该有毒有害物质至少在该部件的某一均质材料中的含量超出 SJ/T 11363-2006 (现由 GB/T 26572-2011 取代) 标准规定的限量要求。