



MODEL:

# TANK-860-HM86 Series

Embedded System with 4th Generation Intel® Core™ processor,  
VGA, DVI-I, DisplayPort, Two Gigabit Ethernet,  
Four USB 3.0, Two USB 2.0, RS-232/422/485,  
RoHS Compliant

## User Manual

# Revision

---

Date	Version	Changes
14 November 2014	1.00	Initial release

# Copyright

---

## COPYRIGHT NOTICE

The information in this document is subject to change without prior notice in order to improve reliability, design and function and does not represent a commitment on the part of the manufacturer.

In no event will the manufacturer be liable for direct, indirect, special, incidental, or consequential damages arising out of the use or inability to use the product or documentation, even if advised of the possibility of such damages.

This document contains proprietary information protected by copyright. All rights are reserved. No part of this manual may be reproduced by any mechanical, electronic, or other means in any form without prior written permission of the manufacturer.

## TRADEMARKS

All registered trademarks and product names mentioned herein are used for identification purposes only and may be trademarks and/or registered trademarks of their respective owners.

# Table of Contents

<b>1 INTRODUCTION.....</b>	<b>12</b>
1.1 OVERVIEW.....	13
1.2 MODEL VARIATIONS .....	14
1.3 FEATURES.....	14
1.4 TECHNICAL SPECIFICATIONS .....	15
1.5 FRONT PANEL.....	17
1.5.1 TANK-860-HM86-2 slot Front Panel.....	17
1.5.2 TANK-860-HM86-4 slot Front Panel.....	19
1.5.3 TANK-860-HM86-6 slot Front Panel.....	21
1.6 REAR PANEL.....	22
1.7 LED INDICATORS .....	23
1.8 BACKPLANE OPTIONS .....	25
1.9 PHYSICAL DIMENSIONS .....	28
1.9.1 TANK-860-HM86-2 slot Physical Dimensions .....	28
1.9.2 TANK-860-HM86-4 slot Physical Dimensions .....	29
1.9.3 TANK-860-HM86-6 slot Physical Dimensions .....	30
<b>2 UNPACKING .....</b>	<b>31</b>
2.1 ANTI-STATIC PRECAUTIONS .....	32
2.2 UNPACKING PRECAUTIONS.....	32
2.3 UNPACKING CHECKLIST .....	33
<b>3 INSTALLATION .....</b>	<b>35</b>
3.1 INSTALLATION PRECAUTIONS .....	36
3.2 CFAST INSTALLATION.....	36
3.3 HARD DISK DRIVE (HDD) INSTALLATION.....	37
3.4 SYSTEM FAN INSTALLATION .....	40
3.5 MOUNTING THE SYSTEM WITH MOUNTING BRACKETS .....	41
3.6 EXTERNAL PERIPHERAL INTERFACE CONNECTORS.....	41
3.6.1 ACC Mode Selection .....	42
3.6.2 AT/ATX Power Mode Selection.....	42

3.6.3 Audio Connector .....	43
3.6.4 CFast Socket .....	44
3.6.5 Digital Input/Output Connector.....	44
3.6.6 DVI Connector.....	44
3.6.7 LAN Connectors.....	45
3.6.8 Power Input, 3-pin Terminal Block.....	47
3.6.9 Power Input, 4-pin DIN Connector .....	47
3.6.10 RJ-45 RS-232 Serial Ports.....	47
3.6.11 DB-9 RS-232/422/485 Serial Port Connectors .....	48
3.6.12 USB Connectors.....	49
3.6.13 VGA Connector .....	50
3.7 POWERING ON/OFF THE SYSTEM .....	51
<b>4 SYSTEM MOTHERBOARD .....</b>	<b>53</b>
4.1 OVERVIEW.....	54
4.1.1 Layout .....	54
4.2 INTERNAL PERIPHERAL CONNECTORS .....	55
4.2.1 Backplane +12V Power Connector (BP_PWR1).....	56
4.2.2 Battery Connector (BAT1).....	56
4.2.3 BIOS Programming Connector (SPI1).....	56
4.2.4 CFast Card connector (CFAST1).....	56
4.2.5 CPU Fan Connector (CPU_FAN1).....	57
4.2.6 EC Debug Connector (LPT_DB1).....	57
4.2.7 EC Programming Connector (JSP11).....	57
4.2.8 LED Connector (J2).....	58
4.2.9 PCH Fan Connector (PCH_FAN).....	58
4.2.10 SATA 3Gb/s Drive Connectors (SATA2).....	58
4.2.11 SATA Power Connectors (CN2, CN3).....	59
4.2.12 TPM Connector (TPM1).....	59
4.3 EXTERNAL INTERFACE PANEL CONNECTORS .....	59
4.3.1 Audio Jack (JAUDIO1).....	60
4.3.2 DIO connector (DIO1).....	60
4.3.3 DisplayPort connector (DISPLAY_PORT1).....	61
4.3.4 DVI Connector (DVI_1).....	61
4.3.5 Ethernet and USB3.0 Connectors (LAN1_USB1).....	62



4.3.6 Ethernet and USB3.0 Connectors (LAN2_USB2).....	62
4.3.7 Power Connector (PWR1) .....	63
4.3.8 Power Connector (PWR2) .....	63
4.3.9 RS-232 Serial Port Connector (COM1_2).....	63
4.3.10 RS-232/422/485 Serial Port Connector (COM3_4) .....	64
4.3.11 RS-232 Serial Port Connectors (LANCOM1).....	64
4.3.12 USB 2.0 Connectors (USB1).....	64
4.3.13 VGA Connector (VGA1).....	65
<b>5 BIOS.....</b>	<b>66</b>
5.1 INTRODUCTION.....	67
5.1.1 Starting Setup.....	67
5.1.2 Using Setup .....	67
5.1.3 Getting Help.....	68
5.1.4 Unable to Reboot after Configuration Changes .....	68
5.1.5 BIOS Menu Bar.....	68
5.2 MAIN.....	70
5.3 ADVANCED.....	71
5.3.1 ACPI Settings .....	72
5.3.2 RTC Wake Settings .....	73
5.3.3 Trusted Computing.....	74
5.3.4 CPU Configuration.....	75
5.3.5 SATA Configuration .....	79
5.3.6 Intel(R) Rapid Start Technology.....	79
5.3.7 USB Configuration.....	81
5.3.8 F81866 Super IO Configuration .....	82
5.3.8.1 Serial Port n Configuration .....	83
5.3.9 F81866 H/W Monitor.....	88
5.3.9.1 Smart Fan Mode Configuration .....	88
5.3.10 Serial Port Console Redirection .....	91
5.3.10.1 Console Redirection Settings .....	93
5.3.11 iEi Feature.....	95
5.4 CHIPSET .....	96
5.4.1 PCH-IO Configuration .....	97
5.4.1.1 PCI Express Configuration .....	98

## TANK-860-HM86 Embedded System

5.4.1.2 PCH Azalia Configuration .....	99
5.4.2 <i>System Agent (SA) Configuration</i> .....	99
5.4.2.1 Graphics Configuration.....	100
5.4.2.2 NB PCIe Configuration.....	102
5.4.2.3 Memory Configuration .....	103
5.5 BOOT.....	104
5.6 SECURITY.....	105
5.7 EXIT .....	107
<b>A SAFETY PRECAUTIONS .....</b>	<b>109</b>
A.1 SAFETY PRECAUTIONS .....	110
A.1.1 <i>General Safety Precautions</i> .....	110
A.1.2 <i>Anti-static Precautions</i> .....	110
A.1.3 <i>Product Disposal</i> .....	111
A.2 MAINTENANCE AND CLEANING PRECAUTIONS .....	112
A.2.1 <i>Maintenance and Cleaning</i> .....	112
A.2.2 <i>Cleaning Tools</i> .....	112
<b>B DIGITAL I/O INTERFACE .....</b>	<b>114</b>
B.1 INTRODUCTION .....	115
B.2 ASSEMBLY LANGUAGE SAMPLE 1 .....	116
B.3 ASSEMBLY LANGUAGE SAMPLE 2.....	116
<b>C HAZARDOUS MATERIALS DISCLOSURE .....</b>	<b>117</b>
C.1 HAZARDOUS MATERIALS DISCLOSURE TABLE FOR IPB PRODUCTS CERTIFIED AS ROHS COMPLIANT UNDER 2002/95/EC WITHOUT MERCURY .....	118

# List of Figures

---

Figure 1-1: TANK-860-HM86 Series .....	13
Figure 1-2: TANK-860-HM86 Series Front Panel .....	17
Figure 1-3: TANK-860-HM86 Series Front Panel .....	19
Figure 1-4: TANK-860-HM86 Series Front Panel .....	21
Figure 1-5: TANK-860-HM86 Series Rear Panel.....	22
Figure 1-6: TANK-860-HM86 Series LED Indicators.....	23
Figure 1-7: 2-slot model .....	25
Figure 1-8: 4-slot model .....	25
Figure 1-9: 6-slot model .....	25
Figure 1-10: TANK-860-HM86-2 slot Physical Dimensions (millimeters).....	28
Figure 1-11: TANK-860-HM86-4 slot Physical Dimensions (millimeters).....	29
Figure 1-12: TANK-860-HM86-6 slot Physical Dimensions (millimeters).....	30
Figure 3-1: CFast Socket .....	37
Figure 3-2: CFast Socket Cover .....	37
Figure 3-3: Unscrew the Cover.....	38
Figure 3-4: Remove the Cover from TANK-860-HM86 Series .....	38
Figure 3-5: HDD Installation .....	39
Figure 3-6: HDD Retention Screws .....	39
Figure 3-7: System Fan Installation .....	40
Figure 3-8: Mounting Bracket Retention Screws .....	41
Figure 3-9: ACC Mode Switch .....	42
Figure 3-10: AT/ATX Power Mode Switch .....	43
Figure 3-11: Audio Connector .....	43
Figure 3-12: DIO Connector.....	44
Figure 3-13: DVI Connector .....	45
Figure 3-14: LAN Connection .....	46
Figure 3-15: RJ-45 Ethernet Connector.....	46
Figure 3-16: 3-pin Terminal Block.....	47
Figure 3-17: Power Input Connector.....	47
Figure 3-18: RJ-45 RS-232 Serial Device Connection.....	48



## TANK-860-HM86 Embedded System

<b>Figure 3-19: RJ-45 RS-232 Serial Port Connector .....</b>	<b>48</b>
<b>Figure 3-20: Serial Device Connector .....</b>	<b>49</b>
<b>Figure 3-21: DB-9 RS-232/422/485 Serial Port Connector .....</b>	<b>49</b>
<b>Figure 3-22: USB Device Connection .....</b>	<b>50</b>
<b>Figure 3-23: VGA Connector .....</b>	<b>51</b>
<b>Figure 3-24: VGA Connector .....</b>	<b>51</b>
<b>Figure 3-25: Power Button .....</b>	<b>52</b>
<b>Figure 4-1: System Motherboard (Front).....</b>	<b>54</b>
<b>Figure 4-2: System Motherboard (Rear).....</b>	<b>55</b>

# List of Tables

---

<b>Table 1-1: TANK-860-HM86 Series Model Variations</b> .....	<b>14</b>
<b>Table 1-2: Technical Specifications</b> .....	<b>17</b>
<b>Table 1-3: LED Indicators Description</b> .....	<b>23</b>
<b>Table 1-4: Supported Signals</b> .....	<b>26</b>
<b>Table 1-5: Rated Voltage and Current</b> .....	<b>26</b>
<b>Table 1-6: Rated Voltage and Current</b> .....	<b>27</b>
<b>Table 1-7: Rated Voltage and Current</b> .....	<b>27</b>
<b>Table 3-1: RJ-45 Ethernet Connector LEDs</b> .....	<b>46</b>
<b>Table 4-1: Peripheral Interface Connectors</b> .....	<b>56</b>
<b>Table 4-2: Backplane +12V Power Connector Pinouts (BP_PWR1)</b> .....	<b>56</b>
<b>Table 4-3: Battery Connector Pinouts (BAT1)</b> .....	<b>56</b>
<b>Table 4-4: BIOS Programming Connector Pinouts (SPI1)</b> .....	<b>56</b>
<b>Table 4-5: CFast Card Connector Pinouts (CFAST1)</b> .....	<b>57</b>
<b>Table 4-6: CPU Fan Connector Pinouts (CPU_FAN1)</b> .....	<b>57</b>
<b>Table 4-7: EC Debug Connector Pinouts (LPT_DB1)</b> .....	<b>57</b>
<b>Table 4-8: EC Programming Connector Pinouts (JSPI1)</b> .....	<b>57</b>
<b>Table 4-9: LED Connector Pinouts (J2)</b> .....	<b>58</b>
<b>Table 4-10: PCH Fan Connector Pinouts (PCH_FAN)</b> .....	<b>58</b>
<b>Table 4-11: SATA 3Gb/s Drive Connectors Pinouts (SATA2)</b> .....	<b>58</b>
<b>Table 4-12: SATA Power Connectors Pinouts (CN2, CN3)</b> .....	<b>59</b>
<b>Table 4-13: TPM Connector Pinouts (TPM1)</b> .....	<b>59</b>
<b>Table 4-14: Rear Panel Connectors</b> .....	<b>60</b>
<b>Table 4-15: Audio Jack Pinouts (AUDIO1)</b> .....	<b>60</b>
<b>Table 4-16: DIO connector Pinouts (DIO1)</b> .....	<b>60</b>
<b>Table 4-17: DisplayPort connector Pinouts (DISPLAY_PORT1)</b> .....	<b>61</b>
<b>Table 4-18: DVI Connector Pinouts (DVI_I)</b> .....	<b>61</b>
<b>Table 4-19: Ethernet and USB3.0 Connectors Pinouts (LAN1_USB1)</b> .....	<b>62</b>
<b>Table 4-20: Ethernet and USB3.0 Connectors Pinouts (LAN2_USB2)</b> .....	<b>63</b>
<b>Table 4-21: Power Connector Pinouts (PWR2)</b> .....	<b>63</b>
<b>Table 4-22: Power Connector Pinouts (PWR1)</b> .....	<b>63</b>

## TANK-860-HM86 Embedded System

<b>Table 4-23: RS-232 Serial Port Connector Pinouts (COM1_2)</b> .....	<b>64</b>
<b>Table 4-24: RS-232/422/485 Serial Port Connector Pinouts (COM3_4)</b> .....	<b>64</b>
<b>Table 4-25: RS-232 Serial Port Connectors Pinouts (LANCOM1)</b> .....	<b>64</b>
<b>Table 4-26: USB 2.0 Connectors Pinouts (USB1)</b> .....	<b>65</b>
<b>Table 4-27: VGA Connector Pinouts (VGA1)</b> .....	<b>65</b>
<b>Table 5-1: BIOS Navigation Keys</b> .....	<b>68</b>

Chapter

1

# Introduction

---

## TANK-860-HM86 Embedded System

### 1.1 Overview



**Figure 1-1: TANK-860-HM86 Series**

The TANK-860-HM86 Series is an embedded system for wide range temperature environments. It is powered by the 4th generation Intel® Core™ processor, uses the Intel® HM86 chipset and supports two 204-pin DDR3 SDRAM SO-DIMM modules up to 16 GB (4GB memory preinstalled). The TANK-860-HM86 Series includes one VGA port, one DVI-I port, one DisplayPort, two GbE LAN ports, four USB 3.0 ports, two USB 2.0 ports, four RS-232 connectors and two RS-232/422/485 connectors.



## 1.2 Model Variations

The model variations of the TANK-860-HM86 Series series are listed below.

Model No.	Variations	CPU	Expansion Slots
TANK-860-HM86	TANK-860-HM86i-i5/4G/2A-R10	Intel® Core™ i5-4400E 2.7 GHz dual-core	2 x PCIe expansion
	TANK-860-HM86i-i5/4G/4A-R10		2 x PCIe and 2 x PCI expansion
	TANK-860-HM86i-i5/4G/6A-R10		3 x PCIe and 3 x PCI expansion
	TANK-860-HM86i-C/4G/2A-R10	Intel® Celeron® 2000E 2.2 GHz dual-core	2 x PCIe expansion
	TANK-860-HM86i-C/4G/4A-R10		2 x PCIe and 2 x PCI expansion
	TANK-860-HM86i-C/4G/6A-R10		3 x PCIe and 3 x PCI expansion

**Table 1-1: TANK-860-HM86 Series Model Variations**

## 1.3 Features

The TANK-860-HM86 Series features are listed below:

- Intel® HM86 chipset + 4th generation Intel® Core™ CPU
- Great flexibility of expansion slots
  - 2 slot model: 2 x PCIe x 16
  - 4 slot model: 2 x PCIe x 16 , 2 x PCI , 1 x PCIe mini slot
  - 6 slot model: 2 x PCIe x 16 , 1 x PCIe x 1 , 3 x PCI , 1 x PCIe mini slot
- IPMI function for remote control management
- Three independent video outputs support high resolution
- 2 x 2.5" SATA HDD bay design fulfills high storage demand

## TANK-860-HM86 Embedded System

### 1.4 Technical Specifications

The TANK-860-HM86 Series technical specifications are listed in **Table 1-2**.

Specifications	
Chassis	
Color	Black C + Silver
Dimensions (WxHxD) (mm)	2 slot: 121.5 x 255.2 x 205 4 slot: 154.8 x 255.2 x 205 6 slot: 195.4 x 255.2 x 205
System Fan	Fanless
Chassis Construction	Extruded aluminum alloys
Motherboard	
Processor CPU	Intel® Core™ i5-4400E 2.7 GHz Intel® Celeron® 2000E 2.2 GHz
Chipset	Intel® HM86
System Memory	2 x 204-pin DDR3 SO-DIMM 4 GB pre-installed (system max: 16 GB)
IPMI	
iRIS Solution	iRIS-2400
Storage	
Hard Drive	2 x 2.5" SATA 6Gb/s HDD/SSD bay
CFast	1 x CFast
mSATA	1 x mSATA (SATA 3Gb/s signal)
I/O Interfaces	
USB 3.0	4
USB 2.0	2
Ethernet	2 x RJ-45 1 x PCIe GbE by Intel® I210 1 x PCIe GbE by Intel® I217LM

Specifications	
RS-232	2 x DB-9 2 x RJ-45
RS-232/422/485	2 x DB-9
Digital I/O	8-bit digital I/O, 4-bit input/4-bit output
Display	1 x VGA, 1 x DVI-I, 1 x DisplayPort
Resolution	VGA: Up to 1920 x 1200@60Hz DVI-I: Up to 2500 x 1600@60Hz DisplayPort: Up to 2500 x 1600@60Hz
Audio	1 x Line-out, 1 x Mic-in
Wireless	802.11b/g/n 1T1R (optional)
Expansions	
PCI/PCIe	Backplane 2 slot model: 2 x PCIe x 16 , 4 slot model: 2 x PCIe x 16 , 2 x PCI , 1 x PCIe mini slot 6 slot model: 2 x PCIe x 16 , 1 x PCIe x 1 , 3 x PCI , 1 x PCIe mini slot
PCIe Mini	1 x Full Size (Co-lay mSATA)
Reliability	
Mounting	Wall mount
Operating Temperature	-20°C ~ 70°C with air flow (SSD), 5% ~ 95%, non-condensing
Operating Shock	Half-sine wave shock 5G, 11ms, 3 shocks per axis
Operating Vibration	MIL-STD-810F 514.5C-2 (with SSD)
Weight (Net/Gross)	2-slot: 4.2 kg/6.3 kg 4-slot: 4.5 kg/6.5 kg 6-slot: 4.8 kg/6.9 kg
Safety/EMC	CE/FCC

TANK-860-HM86 Embedded System

Specifications	
OS	
Supported OS	Microsoft® Windows® 8 Embedded, Microsoft® Windows® Embedded Standard 7 E

**Table 1-2: Technical Specifications**

1.5 Front Panel

1.5.1 TANK-860-HM86-2 slot Front Panel

The front panel of the TANK-860-HM86 Series has the following features (**Figure 1-2**):

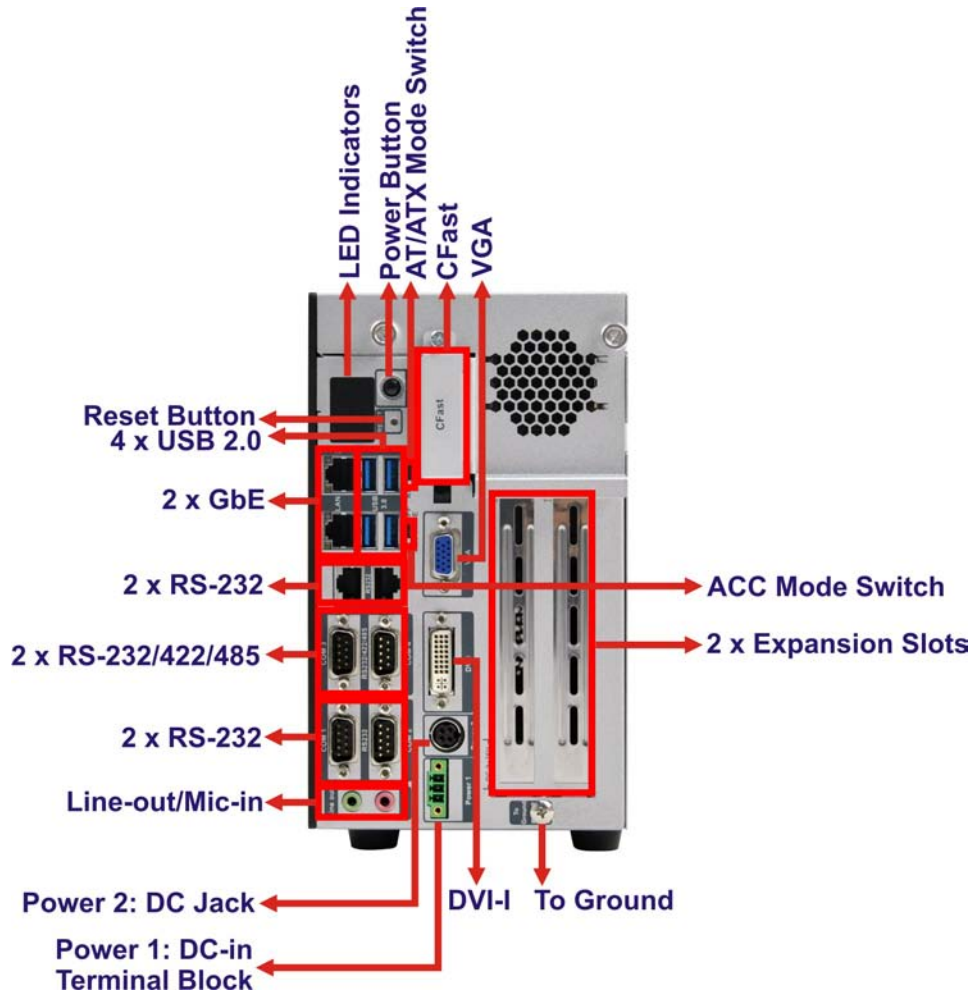

**Figure 1-2: TANK-860-HM86 Series Front Panel**

Connectors and buttons on the front panel include the following:

- 1 x 4-pin power DC jack for 9 V ~ 36 V power input
- 1 x Power terminal block for 9 V ~ 36 V power input
- 1 x Mic-in port (pink)
- 1 x Line-out port (green)
- 2 x RS-232 serial ports (DB-9)
- 2 x RS-232 serial ports (RJ-45)
- 2 x RS-232/422/485 serial ports (DB-9)
- 2 x Gigabit Ethernet ports (RJ-45)
- 4 x USB 2.0 ports
- 1 x Reset button
- 6 x LED indicators (**Section 1.7**)
- 1 x Power button
- 1 x CFast
- 1 x VGA port
- 1 X DVI-I port
- 1 x To Ground
- 2 x Expansion slots
- 1 x ACC mode switch
- 1 x AT/ATX mode switch



## TANK-860-HM86 Embedded System

### 1.5.2 TANK-860-HM86-4 slot Front Panel

The front panel of the TANK-860-HM86 Series has the following features (**Figure 1-2**):

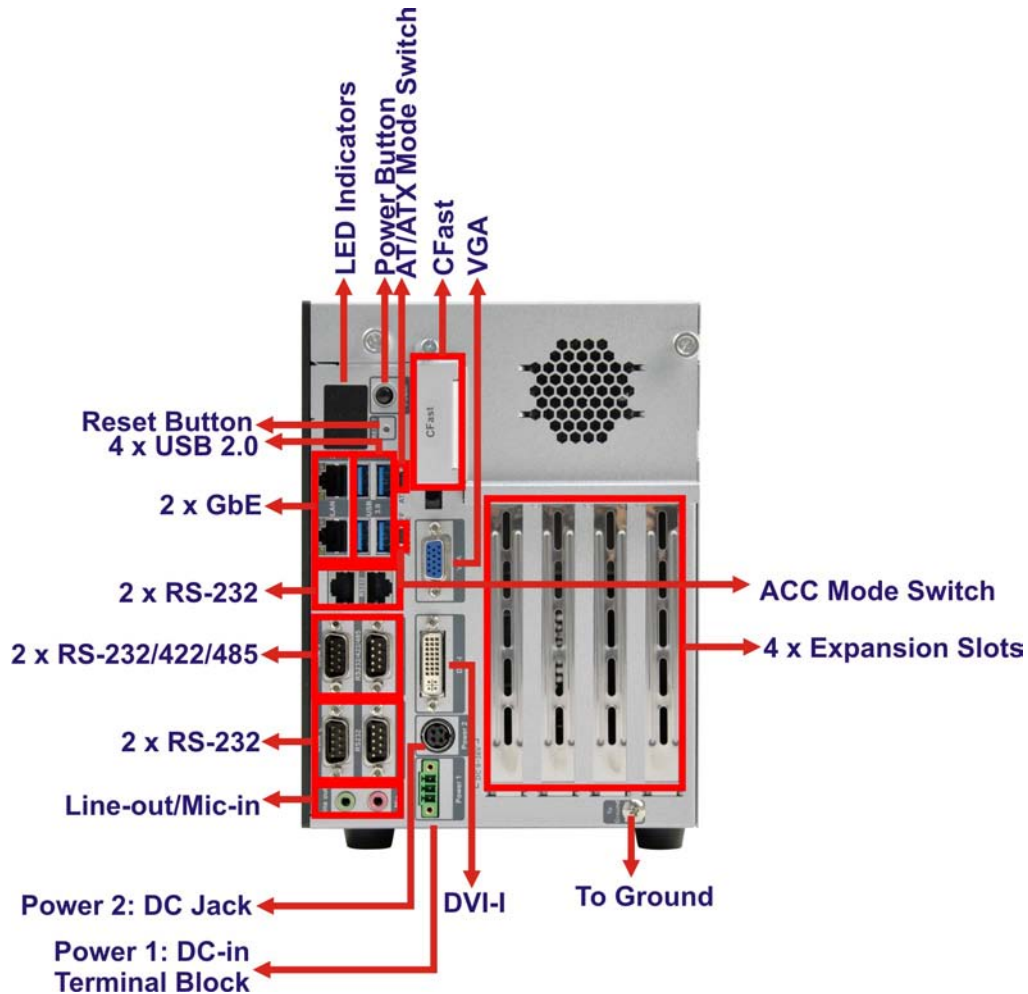

**Figure 1-3: TANK-860-HM86 Series Front Panel**

Connectors and buttons on the front panel include the following:

- 1 x 4-pin power DC jack for 9 V ~ 36 V power input
- 1 x Power terminal block for 9 V ~ 36 V power input
- 1 x Mic-in port (pink)
- 1 x Line-out port (green)
- 2 x RS-232 serial ports (DB-9)
- 2 x RS-232 serial ports (RJ-45)
- 2 x RS-232/422/485 serial ports (DB-9)

- 2 x Gigabit Ethernet ports (RJ-45)
- 4 x USB 2.0 ports
- 1 x Reset button
- 6 x LED indicators (**Section 1.7**)
- 1 x Power button
- 1 x CFast
- 1 x VGA port
- 1 X DVI-I port
- 1 x To Ground
- 4 x Expansion slots
- 1 x ACC mode switch
- 1 x AT/ATX mode switch

## TANK-860-HM86 Embedded System

### 1.5.3 TANK-860-HM86-6 slot Front Panel

The front panel of the TANK-860-HM86 Series has the following features (**Figure 1-2**):

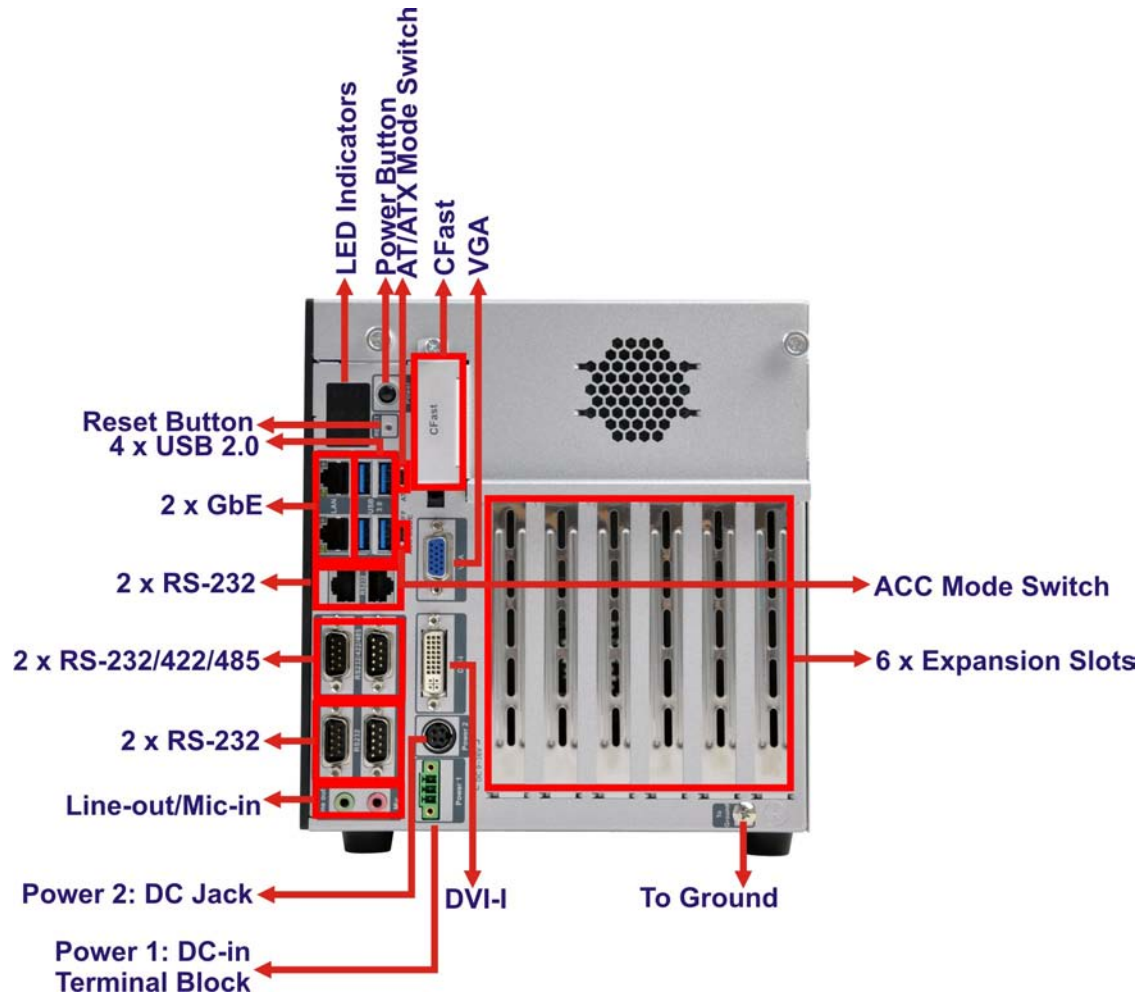

**Figure 1-4: TANK-860-HM86 Series Front Panel**

Connectors and buttons on the front panel include the following:

- 1 x 4-pin power DC jack for 9 V ~ 36 V power input
- 1 x Power terminal block for 9 V ~ 36 V power input
- 1 x Mic-in port (pink)
- 1 x Line-out port (green)
- 2 x RS-232 serial ports (DB-9)
- 2 x RS-232 serial ports (RJ-45)
- 2 x RS-232/422/485 serial ports (DB-9)

- 2 x Gigabit Ethernet ports (RJ-45)
- 4 x USB 2.0 ports
- 1 x Reset button
- 6 x LED indicators (**Section 1.7**)
- 1 x Power button
- 1 x CFast
- 1 x VGA port
- 1 X DVI-I port
- 1 x To Ground
- 6 x Expansion slots
- 1 x ACC mode switch
- 1 x AT/ATX mode switch

## 1.6 Rear Panel

The rear panel of the TANK-860-HM86 Series has the following features (**Figure 1-2**):



**Figure 1-5: TANK-860-HM86 Series Rear Panel**

Connectors on the front panel include the following:

- 1 x DisplayPort connector
- 1 x DIO connector



TANK-860-HM86 Embedded System

- 2 x USB 2.0 ports

### 1.7 LED Indicators

There are several indicators on the rear panel of the TANK-860-HM86 Series as shown in **Figure 1-6**.

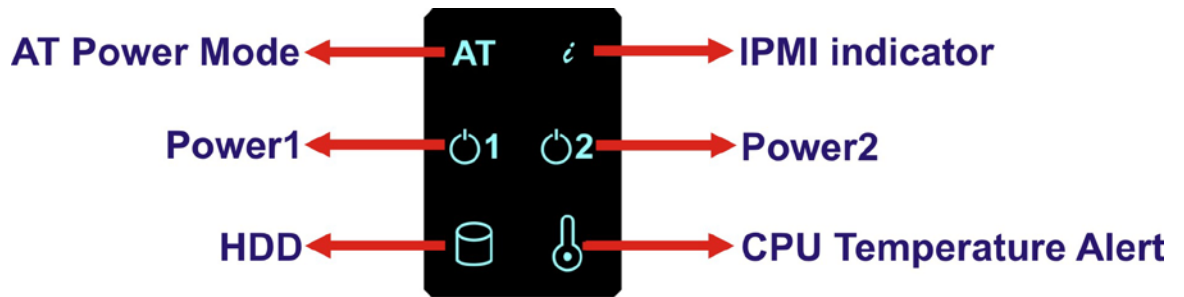

**Figure 1-6: TANK-860-HM86 Series LED Indicators**

The descriptions of each LED indicator are listed below.

LED Indicator	Description
AT Power Mode	The current power mode status is AT mode. Controlled by the AT/ATX power mode switch.
i	Shows IPMI status.
Power 1	<b>Breathing orange:</b> Standby mode.
Power 2	<b>Solid blue:</b> Power-on mode.
HDD	Shows HDD status.
CPU Temperature Alert	BLUE: CPU temperature is normal. RED: CPU temperature is too high.

**Table 1-3: LED Indicators Description**





**WARNING:**

The CPU Temperature Alert LED turns red when the CPU temperature is too high. If this situation occurs, lower the environment temperature or close some running applications to cool down the CPU.

---

TANK-860-HM86 Embedded System

1.8 Backplane Options

The backplane options of the TANK-860-HM86 Series are shown below.

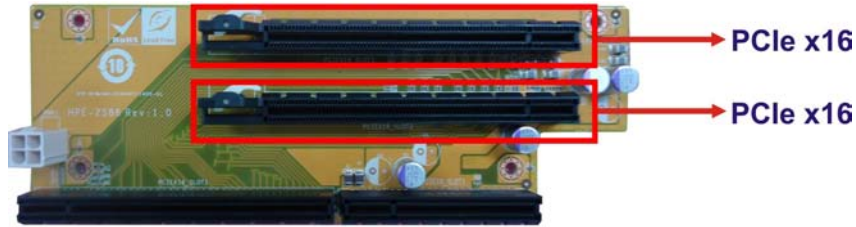

Figure 1-7: 2-slot model



Figure 1-8: 4-slot model

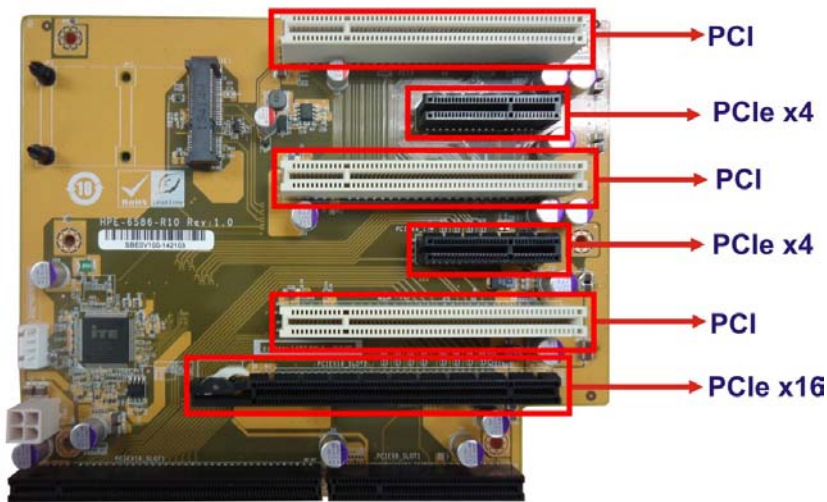

Figure 1-9: 6-slot model

The supported signals of the backplane slots are listed below.

Backplane	Slot	Signal
2-slot model	PCIe x16	PCIe x8
	PCIe x16	PCIe x8
4-slot model	PCIe x16	PCIe x8
	PCIe x16	PCIe x8
	PCI	PCI
	PCI	PCI
6-slot model	PCIe x16	PCIe x8
	PCIe x4	PCIe x4
	PCIe x4	PCIe x4
	PCI	PCI
	PCI	PCI
	PCI	PCI

**Table 1-4: Supported Signals**

The rated voltage and current of the backplanes are listed below.

120W/19V adaptor backplane total power limit:30W

Rated Voltage	Rated Current
+5 V	4.0 A
+12 V	2.5 A
-12 V	0.1 A
+3.3 V	5.0 A

**Table 1-5: Rated Voltage and Current**

150W/12V adaptor backplane total power limit:50W

Rated Voltage	Rated Current
+5 V	4.0 A
+12 V	4.0A
-12 V	0.1 A

## TANK-860-HM86 Embedded System

+3.3 V	5.0 A
--------	-------

**Table 1-6: Rated Voltage and Current**

180W/19V adaptor backplane total power limit:70W

Rated Voltage	Rated Current
+5 V	4.0 A
+12 V	5.5 A
-12 V	0.1 A
+3.3 V	5.0 A

**Table 1-7: Rated Voltage and Current****WARNING:**

The system default power is 120 W. The maximum total power of the backplane to support expansion cards is 30 W. The power of the selected expansion cards can not exceed the max. power (30 W), otherwise, the system may be unstable.

**NOTE:**

When using an expansion card with high power consumption, it is recommended to install an external power supply to the 12V power input connector on the backplane.

## 1.9 Physical Dimensions

The following sections describe the physical dimensions for each model of the TANK-860-HM86 Series series.

### 1.9.1 TANK-860-HM86-2 slot Physical Dimensions

The physical dimensions of the TANK-860-HM86-2 slot are shown in **Figure 1-10**.

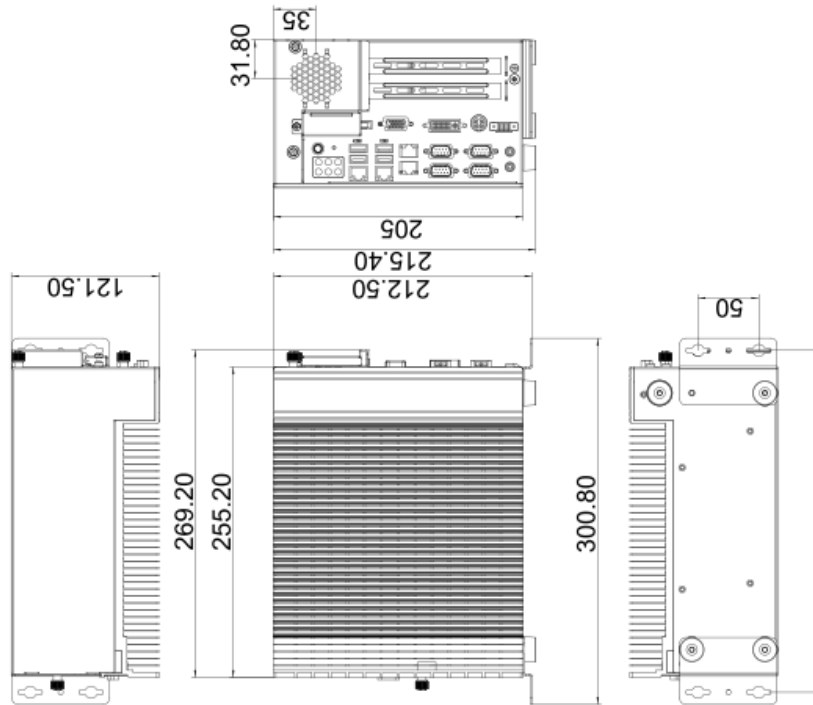

**Figure 1-10: TANK-860-HM86-2 slot Physical Dimensions (millimeters)**



TANK-860-HM86 Embedded System

1.9.2 TANK-860-HM86-4 slot Physical Dimensions

The physical dimensions of the TANK-860-HM86-4 slot are shown in **Figure 1-11**.

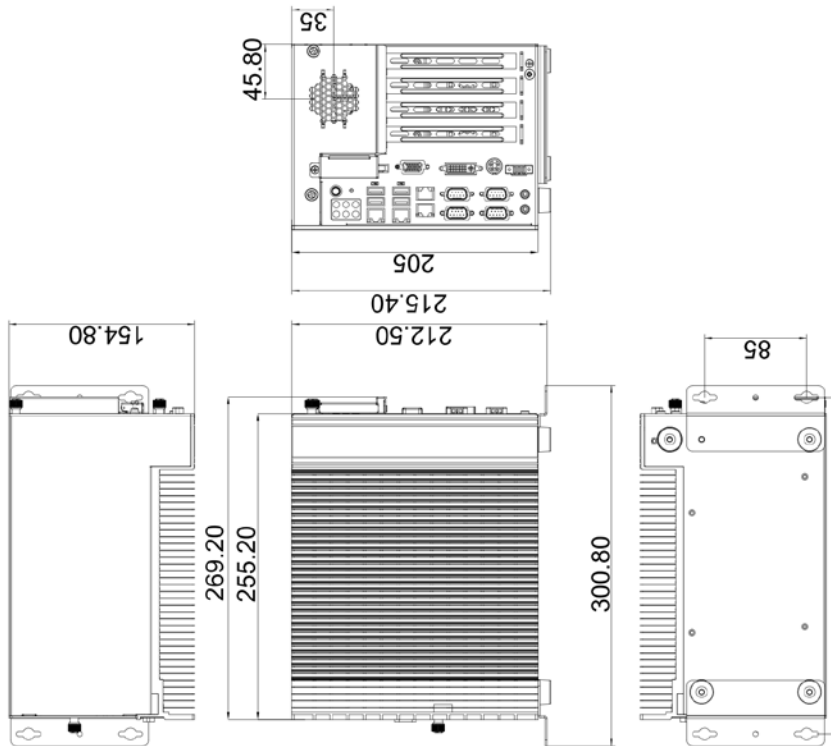

**Figure 1-11: TANK-860-HM86-4 slot Physical Dimensions (millimeters)**

1.9.3 TANK-860-HM86-6 slot Physical Dimensions

The physical dimensions of the TANK-860-HM86-6 slot are shown in **Figure 1-12**.

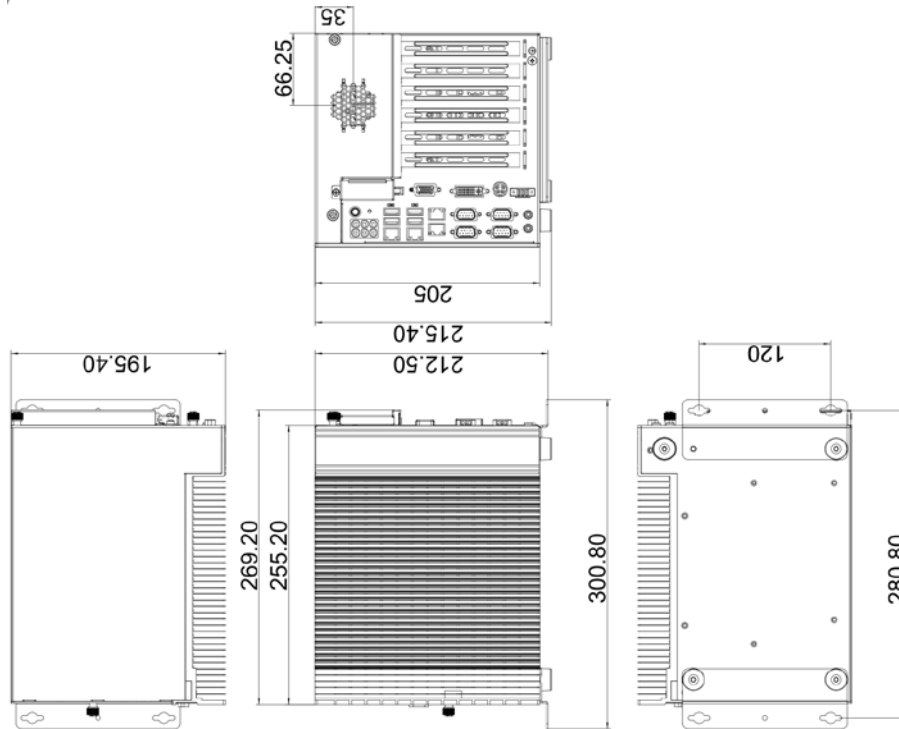

**Figure 1-12: TANK-860-HM86-6 slot Physical Dimensions (millimeters)**

Chapter

2

# Unpacking

---

## 2.1 Anti-static Precautions

---



### WARNING:

Failure to take ESD precautions during installation may result in permanent damage to the TANK-860-HM86 Series and severe injury to the user.

---

Electrostatic discharge (ESD) can cause serious damage to electronic components, including the TANK-860-HM86 Series. Dry climates are especially susceptible to ESD. It is therefore critical that whenever the TANK-860-HM86 Series or any other electrical component is handled, the following anti-static precautions are strictly adhered to.

- **Wear an anti-static wristband:** Wearing a simple anti-static wristband can help to prevent ESD from damaging the board.
- **Self-grounding:** Before handling the board touch any grounded conducting material. During the time the board is handled, frequently touch any conducting materials that are connected to the ground.
- **Use an anti-static pad:** When configuring the TANK-860-HM86 Series, place it on an anti-static pad. This reduces the possibility of ESD damaging the TANK-860-HM86 Series.

## 2.2 Unpacking Precautions

When the TANK-860-HM86 Series is unpacked, please do the following:

- Follow the anti-static precautions outlined in **Section 2.1**.
- Make sure the packing box is facing upwards so the TANK-860-HM86 Series does not fall out of the box.
- Make sure all the components shown in **Section 2.3** are present.





## 2.3 Unpacking Checklist



**NOTE:**



If some of the components listed in the checklist below are missing, please do not proceed with the installation. Contact the IEI reseller or vendor you purchased the TANK-860-HM86 Series from or contact an IEI sales representative directly. To contact an IEI sales representative, please send an email to [sales@iei.com.tw](mailto:sales@iei.com.tw).

The TANK-860-HM86 Series is shipped with the following components:

Quantity	Item and Part Number	Image
Standard		
1	TANK-860-HM86 Series	
2	Mounting Brackets	
1	One Key Recovery CD (P/N: 7B000-000724-RS)	
1	User Manual and Driver CD	

The following table lists the optional items that can be purchased separately.



Optional	
<p>System Fan (P/N: 19FR124010BL-000003-RS)</p>	
<p>Power Adapter (120W) (P/N: 63040-010090-050-RS)</p> <p>Note: *90W adapter is suggested for no add-on cards applications. For add-on cards applications, please choose adapter based on power consumption of TANK-860 (65W) + add-on card power consumption.</p>	
<p>Power Cord</p>	

Chapter

3

# Installation

---

### 3.1 Installation Precautions

During installation, be aware of the precautions below:

- **Read the user manual:** The user manual provides a complete description of the TANK-860-HM86 Series, installation instructions and configuration options.
- **DANGER! Disconnect Power:** Power to the TANK-860-HM86 Series must be disconnected during the installation process, or before any attempt is made to access the rear panel. Electric shock and personal injury might occur if the rear panel of the TANK-860-HM86 Series is opened while the power cord is still connected to an electrical outlet.
- **Qualified Personnel:** The TANK-860-HM86 Series must be installed and operated only by trained and qualified personnel. Maintenance, upgrades, or repairs may only be carried out by qualified personnel who are familiar with the associated dangers.
- **Air Circulation:** Make sure there is sufficient air circulation when installing the TANK-860-HM86 Series. The TANK-860-HM86 Series's cooling vents must not be obstructed by any objects. Blocking the vents can cause overheating of the TANK-860-HM86 Series. Leave at least 5 cm of clearance around the TANK-860-HM86 Series to prevent overheating.
- **Grounding:** The TANK-860-HM86 Series should be properly grounded. The voltage feeds must not be overloaded. Adjust the cabling and provide external overcharge protection per the electrical values indicated on the label attached to the back of the TANK-860-HM86 Series.

### 3.2 CFast Installation

To install the CFast card, please follow the steps below:

**Step 1:** Locate the CFast socket, and then loosen the thumbscrew (**Figure 3-1**).

## TANK-860-HM86 Embedded System



**Figure 3-1: CFast Socket**

**Step 2:** Open the CFast socket cover (Figure 3-2).

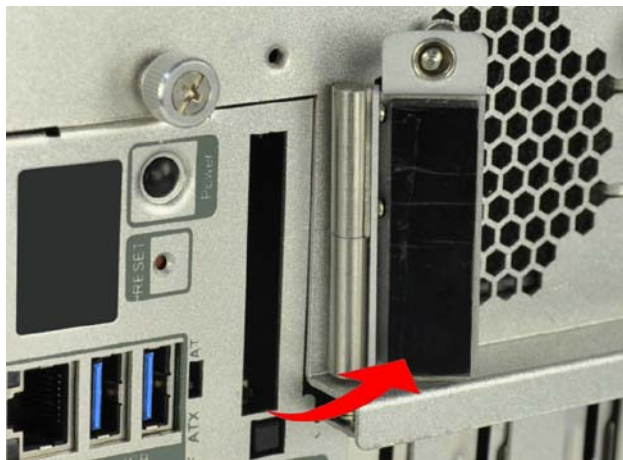

**Figure 3-2: CFast Socket Cover**

**Step 3:** Correctly align the CFast card with the socket and insert the CFast card into the socket.

**Step 4:** Reinstall the cover.

### 3.3 Hard Disk Drive (HDD) Installation

To install the hard drive, please follow the steps below:

**Step 1:** Remove the two retention screws on the rear panel and loosen the two thumbscrews on the front panel, slide the cover inwards, and then lift the cover up gently (**Figure 3-3**).



**Figure 3-3: Unscrew the Cover**

**Step 2:** Unplug the SATA signal and power cables connected to the TANK-860-HM86 Series, and then put the cover on a flat surface (**Figure 3-4**).

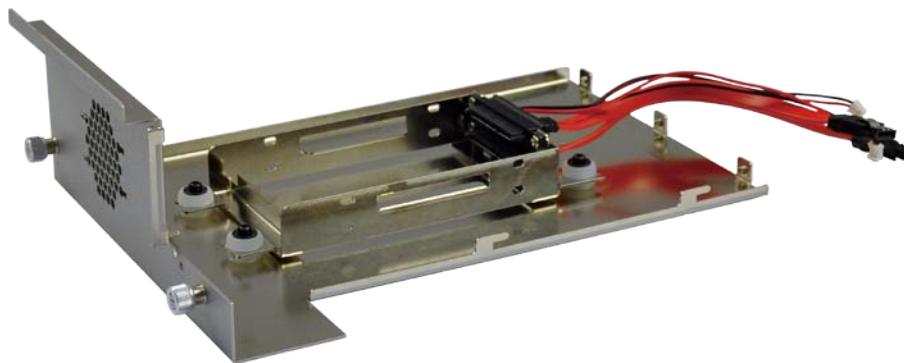
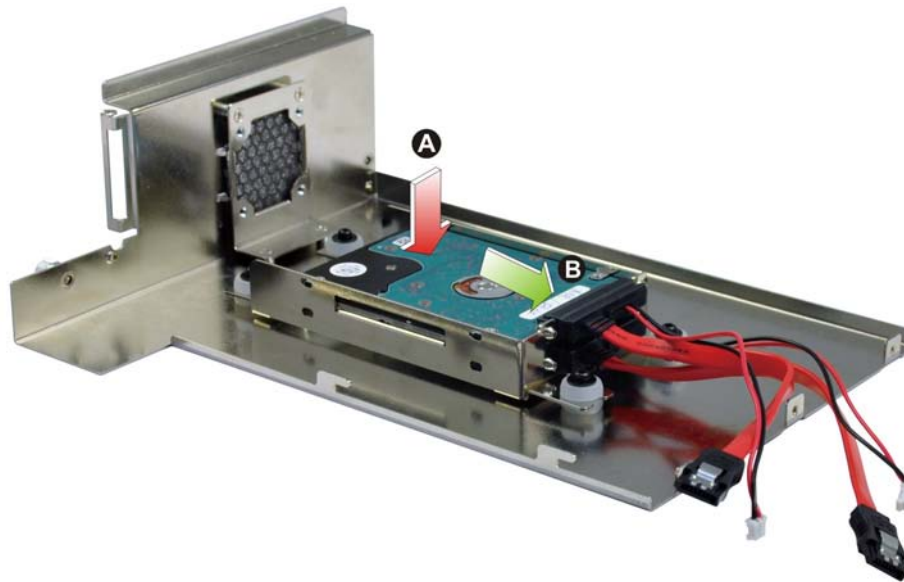

**Figure 3-4: Remove the Cover from TANK-860-HM86 Series**

**Step 3:** Attach the HDD to the HDD bracket, and then slide the HDD to connect the HDD to the SATA connector (**Figure 3-5**).



## TANK-860-HM86 Embedded System



**Figure 3-5: HDD Installation**

**Step 4:** Secure the HDD with the HDD bracket by four retention screws (**Figure 3-6**).

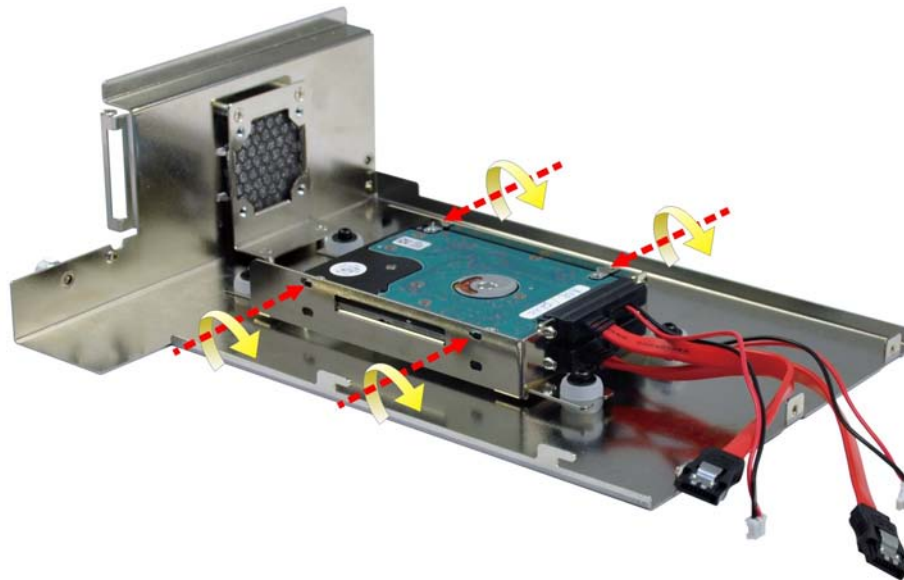

**Figure 3-6: HDD Retention Screws**

**Step 5:** Reconnect the SATA signal and power cables to the TANK-860-HM86 Series.

**Step 6:** Reinstall the cover.

### 3.4 System Fan Installation

To install the optional system fan, please follow the steps below:

- Step 1:** Remove the two retention screws on the rear panel and loosen the two thumbscrews on the front panel, slide the cover inwards, and then lift the cover up gently (**Figure 3-3**).
- Step 2:** Unplug the SATA signal and power cables connected to the TANK-860-HM86 Series, and then place the cover on a flat surface (**Figure 3-4**).
- Step 3:** Attach the system fan to the TANK-860-HM86 Series and secure it by four retention screws (**Figure 3-7**).

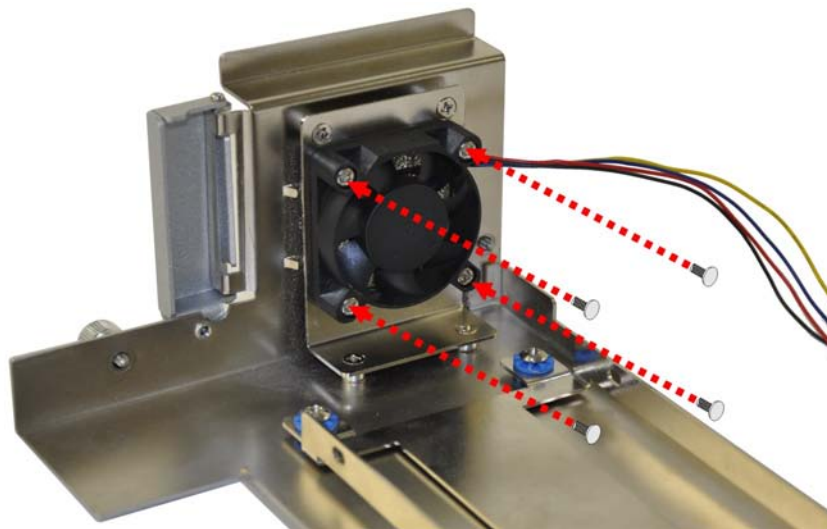

**Figure 3-7: System Fan Installation**

- Step 4:** Connect the system fan cable to the **CPU\_FAN** connector on the motherboard of TANK-860-HM86 Series.
- Step 5:** Reconnect the SATA signal and power cables to the TANK-860-HM86 Series.
- Step 6:** Reinstall the cover.

### 3.5 Mounting the System with Mounting Brackets

To mount the embedded system onto a wall or some other surface using the two mounting brackets, please follow the steps below.

**Step 1:** Turn the embedded system to the left side panel.

**Step 2:** Align the two retention screw holes in each bracket with the corresponding retention screw holes on the bottom surface or the left side panel (**Figure 3-8**).

#### Left Side Panel



**Figure 3-8: Mounting Bracket Retention Screws**

**Step 3:** Secure the brackets to the system by inserting two retention screws into each bracket (**Figure 3-8**).

**Step 4:** Drill holes in the intended installation surface.

**Step 5:** Align the mounting holes in the sides of the mounting brackets with the predrilled holes in the mounting surface.

**Step 6:** Insert four retention screws, two in each bracket, to secure the system to the wall.

### 3.6 External Peripheral Interface Connectors

The TANK-860-HM86 Series has the following connectors. Detailed descriptions of the connectors can be found in the subsections below.

- ACC mode switch

- AT/ATX power mode switch
- Audio
- CFast Socket
- DIO
- DVI-I
- Ethernet
- Power button
- Power DC jack
- Power terminal block
- Reset button
- RS-232
- RS-232/422/485
- USB
- VGA

### 3.6.1 ACC Mode Selection

The TANK-860-HM86 Series allows turning the ACC mode on or off. The setting can be made through the ACC mode switch on the external peripheral interface panel as shown below.

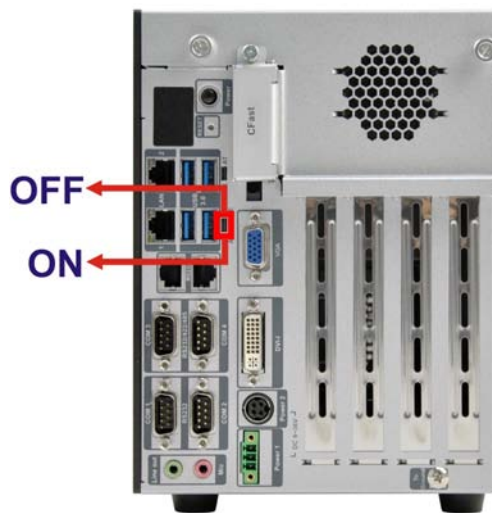

**Figure 3-9: ACC Mode Switch**

### 3.6.2 AT/ATX Power Mode Selection



## TANK-860-HM86 Embedded System

The TANK-860-HM86 Series supports AT and ATX power modes. The setting can be made through the AT/ATX power mode switch on the external peripheral interface panel as shown below.

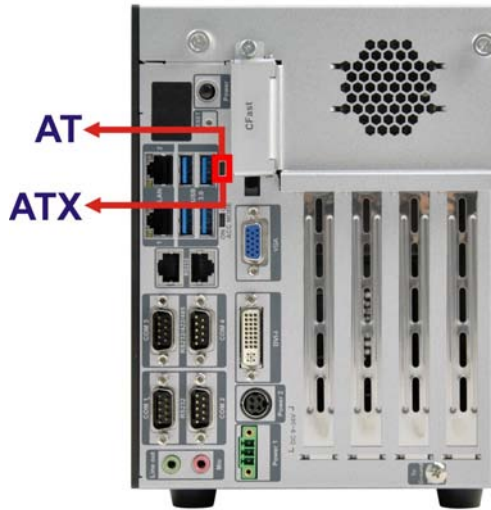

Figure 3-10: AT/ATX Power Mode Switch

### 3.6.3 Audio Connector

The audio jacks connect to external audio devices.

- **Line Out port (Green):** Connects to a headphone or a speaker. With multi-channel configurations, this port can also connect to front speakers.
- **Microphone (Pink):** Connects a microphone.



Figure 3-11: Audio Connector



### 3.6.4 CFast Socket

The TANK-860-HM86 Series has one CFast socket. The location of the socket is shown in **Figure 1-2**. To install the CFast card, refer to **Section 3.2**.

### 3.6.5 Digital Input/Output Connector

The digital I/O connector provides programmable input and output for external devices. The pinouts for the digital I/O connector are listed in the table below.

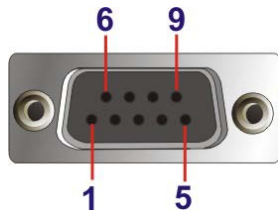
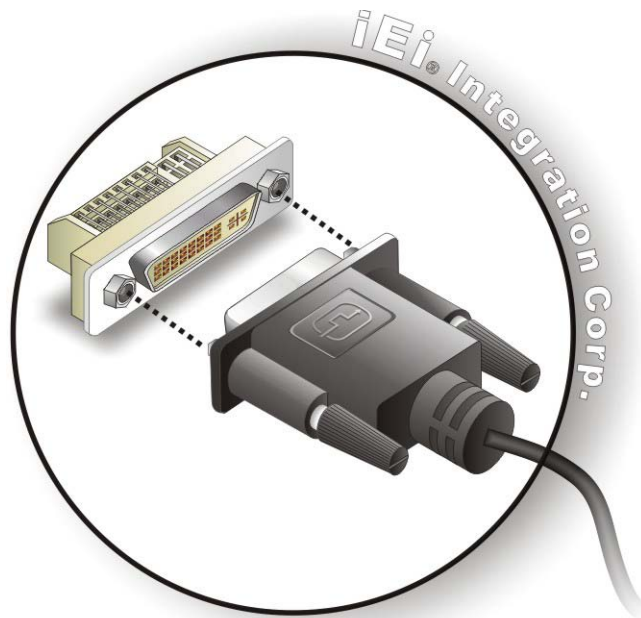

**Figure 3-12: DIO Connector**

### 3.6.6 DVI Connector

The TANK-860-HM86 Series has one female DVI-I connector on the front panel. The DVI connectors are connected to digital display devices. To connect a digital display device to the TANK-860-HM86 Series, please follow the instructions below.

- Step 1: Locate the DVI connector.** The location of the DVI connector is shown in **Chapter 1**.
- Step 2: Align the DVI connector.** Align the male DVI connector on the digital display device cable with the female DVI connector on the external peripheral interface.
- Step 3: Insert the DVI connector.** Once the connectors are properly aligned with the male connector, insert the male connector from the digital display device into the female connector on the TANK-860-HM86 Series. See **Figure 3-13**.



**Figure 3-13: DVI Connector**

- Step 4: Secure the connector.** Secure the DVI connector from the digital display device to the external interface by tightening the two retention screws on either side of the connector.

### 3.6.7 LAN Connectors

The LAN connectors allow connection to an external network.

- Step 1: Locate the RJ-45 connectors.** The locations of the RJ-45 connectors are shown in **Figure 1-2**.
- Step 2: Align the connectors.** Align the RJ-45 connector on the LAN cable with one of the RJ-45 connectors on the TANK-860-HM86 Series. See **Figure 3-14**.

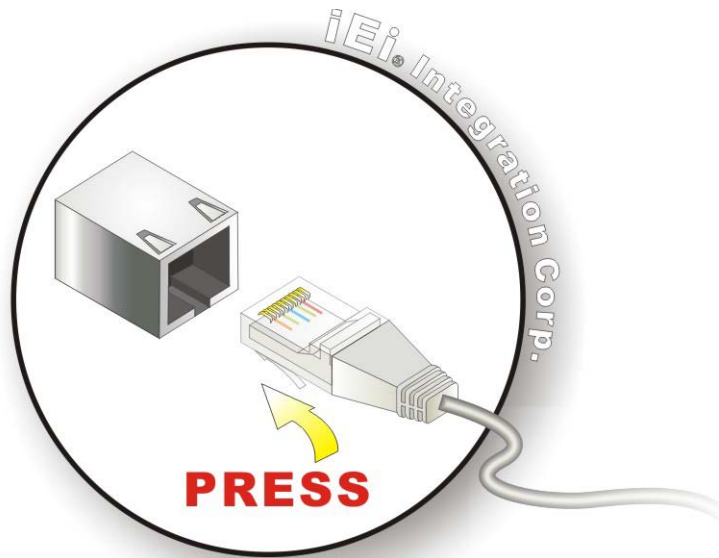

**Figure 3-14: LAN Connection**

**Step 3:** Insert the LAN cable RJ-45 connector. Once aligned, gently insert the LAN cable RJ-45 connector into the on-board RJ-45 connector.



**Figure 3-15: RJ-45 Ethernet Connector**

The RJ-45 Ethernet connector has two status LEDs, one green and one yellow. The green LED indicates activity on the port and the yellow LED indicates the port is linked. See **Table 3-1**.

Activity/Link LED		Speed LED	
STATUS	DESCRIPTION	STATUS	DESCRIPTION
Off	No link	Off	10 Mbps connection
Yellow	Linked	Green	100 Mbps connection
Blinking	TX/RX activity	Orange	1 Gbps connection

**Table 3-1: RJ-45 Ethernet Connector LEDs**

## TANK-860-HM86 Embedded System

## 3.6.8 Power Input, 3-pin Terminal Block

The power connector connects the leads of a 9 V~36 V DC power supply into the terminal block. Make sure that the power and ground wires are attached to the correct sockets of the connector.

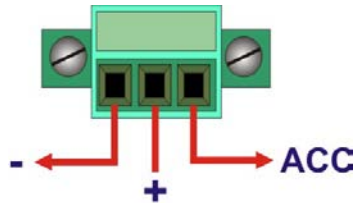

Figure 3-16: 3-pin Terminal Block

## 3.6.9 Power Input, 4-pin DIN Connector

The power connector connects to the 9 V~36 V DC power adapter.



Figure 3-17: Power Input Connector

## 3.6.10 RJ-45 RS-232 Serial Ports

RS-232 serial port devices can be attached to the RJ-45 RS-232/422/485 serial ports on the rear panel.

**Step 1: Locate the RJ-45 RS-232 connectors.** The locations of the RJ-45 RS-232 connectors are shown in **Figure 1-2**.

**Step 2: Insert the RJ-45 connector.** Insert the RJ-45 connector on the RJ-45 to DB-9 COM port cable to one of the RJ-45 RS-232 connectors on the TANK-860-HM86 Series. See **Figure 3-18**.

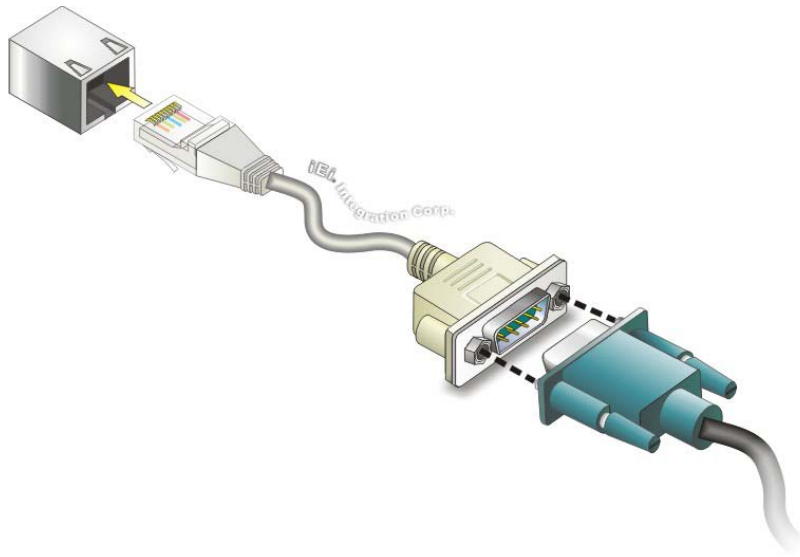

**Figure 3-18: RJ-45 RS-232 Serial Device Connection**

**Step 3: Insert the serial connector.** Insert the DB-9 connector of a serial device into the DB-9 connector on the RJ-45 to DB-9 COM port cable.

**Step 4: Secure the connector.** Secure the serial device connector to the external interface by tightening the two retention screws on either side of the connector.

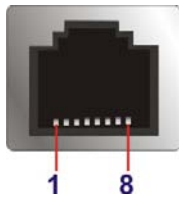

**Figure 3-19: RJ-45 RS-232 Serial Port Connector**

### 3.6.11 DB-9 RS-232/422/485 Serial Port Connectors

DB-9 RS-232/422/485 serial port devices can be attached to the DB-9 ports on the rear panel.

**Step 1: Locate the DB-9 connector.** The locations of the DB-9 connectors are shown in **Figure 1-2**.



## TANK-860-HM86 Embedded System

**Step 2: Insert the serial connector.** Insert the DB-9 connector of a serial device into the DB-9 connector on the external peripheral interface. See **Figure 3-20**.

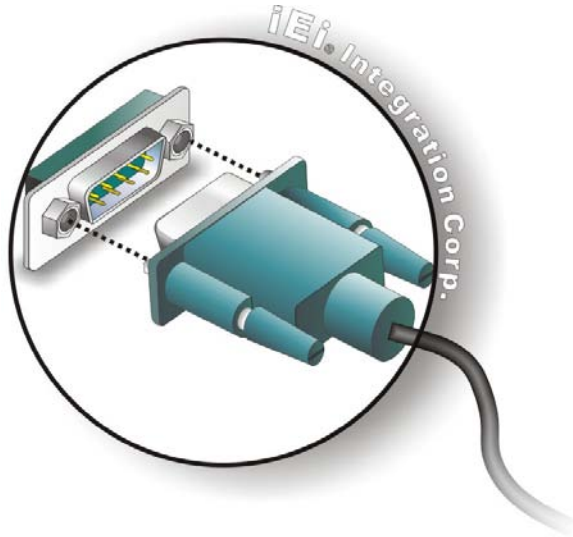

**Figure 3-20: Serial Device Connector**

**Step 3: Secure the connector.** Secure the serial device connector to the external interface by tightening the two retention screws on either side of the connector.

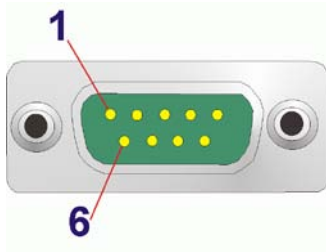

**Figure 3-21: DB-9 RS-232/422/485 Serial Port Connector**

### 3.6.12 USB Connectors

The USB ports are for connecting USB peripheral devices to the system.

**Step 1: Locate the USB connectors.** The locations of the USB connectors are shown in **Figure 1-2**.

**Step 2:** **Align the connectors.** Align the USB device connector with one of the connectors. See **Figure 3-22**.

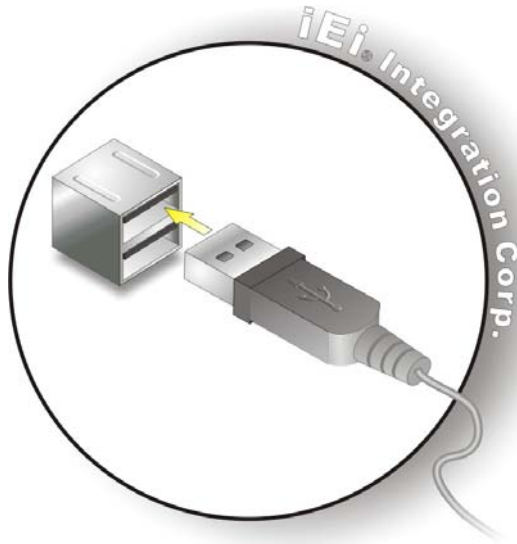

**Figure 3-22: USB Device Connection**

**Step 3:** **Insert the device connector.** Once aligned, gently insert the USB device connector into the on-board connector.

### 3.6.13 VGA Connector

The VGA connector connects to a monitor that accepts VGA video input.

**Step 1:** **Locate the female DB-15 connector.** The location of the female DB-15 connector is shown in **Figure 1-2**.

**Step 2:** **Align the VGA connector.** Align the male DB-15 connector on the VGA screen cable with the female DB-15 connector on the external peripheral interface.

**Step 3:** **Insert the VGA connector** Once the connectors are properly aligned with, insert the male connector from the VGA screen into the female connector on the TANK-860-HM86 Series. See **Figure 3-23**.

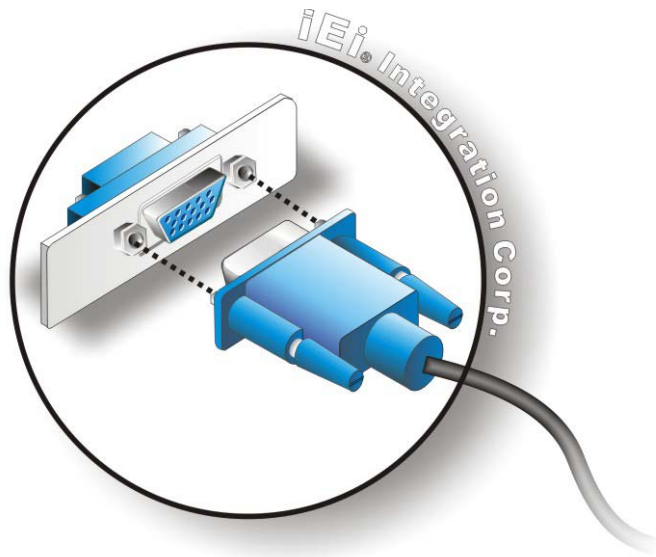

Figure 3-23: VGA Connector

**Step 4: Secure the connector.** Secure the DB-15 VGA connector from the VGA monitor to the external interface by tightening the two retention screws on either side of the connector.

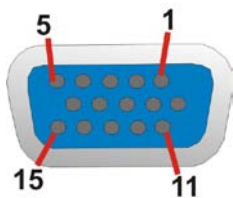

Figure 3-24: VGA Connector

### 3.7 Powering On/Off the System



#### **WARNING:**

Make sure a power supply with the correct input voltage is being fed into the system. Incorrect voltages applied to the system may cause damage to the internal electronic components and may also cause injury to the user.

- **Power on** the system: press the power button for 3 seconds
- **Power off** the system: press the power button for 6 seconds



Figure 3-25: Power Button

Chapter

4

# System Motherboard

---



## 4.1 Overview

This chapter details all the jumpers and connectors of the system motherboard.

### 4.1.1 Layout

The figures below show all the connectors and jumpers of the system motherboard. The Pin 1 locations of the on-board connectors are also indicated in the diagram below.

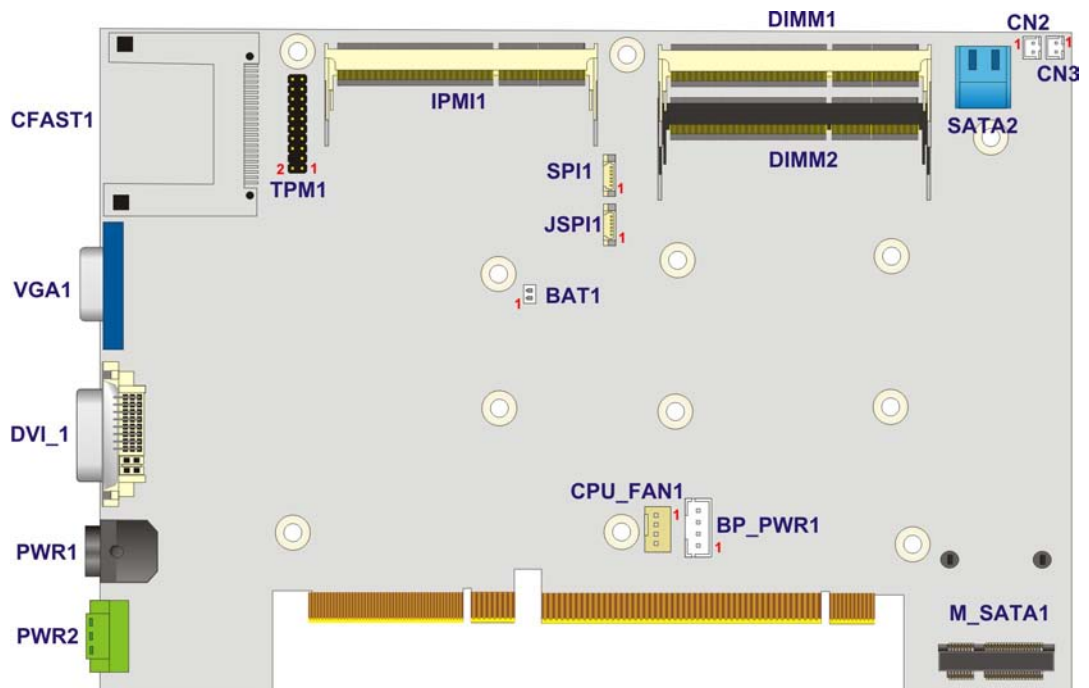

**Figure 4-1: System Motherboard (Front)**



Figure 4-2: System Motherboard (Rear)

## 4.2 Internal Peripheral Connectors

The table below shows a list of the internal peripheral interface connectors on the system motherboard. Pinouts of these connectors can be found in the following sections.

Connector	Type	Label
Backplane +12V power connector	4-pin wafer	BP_PWR1
Battery connector	2-pin wafer	BAT1
BIOS programming connector	6-pin wafer	SPI1
CFast card connector	CFast socket	CFAST1
CPU fan connector	4-pin wafer	CPU_FAN1
DDR3 SO-DIMM slot	DDR3 SO-DIMM slot	DIMM1, DIMM2
EC debug connector	20-pin FPC connector	LPT_DB1
EC programming connector	6-pin wafer	JSPI1
LED connector	12-pin header	J2
SATA 3Gb/s drive connectors	14-pin SATA connector	SATA2
SATA power connectors	2-pin wafer	CN2, CN3
TPM connector	20-pin header	TPM1

Connector	Type	Label
-----------	------	-------

**Table 4-1: Peripheral Interface Connectors**

4.2.1 Backplane +12V Power Connector (BP\_PWR1)

PIN NO.	DESCRIPTION	PIN NO.	DESCRIPTION
1	+12V	2	+12V
3	GND	4	GND

**Table 4-2: Backplane +12V Power Connector Pinouts (BP\_PWR1)**

4.2.2 Battery Connector (BAT1)

PIN NO.	DESCRIPTION
1	VBATT
2	GND

**Table 4-3: Battery Connector Pinouts (BAT1)**

4.2.3 BIOS Programming Connector (SPI1)

PIN NO.	DESCRIPTION	PIN NO.	DESCRIPTION
1	+SPI_VCC	2	SPI_CS#0_CN
3	SPI_S00_CN	4	SPI_CLK0_CN
5	SPI_S10_CN	6	GND

**Table 4-4: BIOS Programming Connector Pinouts (SPI1)**

4.2.4 CFast Card connector (CFAST1)

PIN NO.	DESCRIPTION	PIN NO.	DESCRIPTION
S1	GND	S2	SATA_TX2+
S3	SATA_TX2-	S4	GND
S5	SATA_RX2-	S6	SATA_RX2+
S7	GND	PC1	CFAST_EN#
PC2	GND	PC7	GND
PC13	+3.3V	PC14	+3.3V

## TANK-860-HM86 Embedded System

PC15	GND	PC16	GND
------	-----	------	-----

**Table 4-5: CFast Card Connector Pinouts (CFAST1)**

### 4.2.5 CPU Fan Connector (CPU\_FAN1)

PIN NO.	DESCRIPTION	PIN NO.	DESCRIPTION
1	GND	2	+12V
3	FANIO1	4	FANOUT1

**Table 4-6: CPU Fan Connector Pinouts (CPU\_FAN1)**

### 4.2.6 EC Debug Connector (LPT\_DB1)

PIN NO.	DESCRIPTION	PIN NO.	DESCRIPTION
1	KSI0	11	KSO9
2	KSO0	12	KSO10
3	KSO1	13	KSO12
4	KSO2	14	KSI1
5	KSO3	15	KSO11
6	KSO4	16	KSI2
7	KSO5	17	KSI3
8	KSO6	18	GND
9	KSO7	19	GND
10	KSO8	20	GND

**Table 4-7: EC Debug Connector Pinouts (LPT\_DB1)**

### 4.2.7 EC Programming Connector (JSPI1)

PIN NO.	DESCRIPTION	PIN NO.	DESCRIPTION
1	+SPI_VCC_EC	2	SPI_CS0#_CN_EC
3	SPI_S00_CN_EC	4	SPI_CLK0_CN_EC
5	SPI_SIO_CN_EC	6	GND

**Table 4-8: EC Programming Connector Pinouts (JSPI1)**

#### 4.2.8 LED Connector (J2)

PIN NO.	DESCRIPTION	PIN NO.	DESCRIPTION
1	+V3.3S_LED	2	+V3.3A_EC_LED
3	LRST_PD#	4	LATX_LED#
5	LPWRLED01#	6	LPWRLED02#
7	LIPMI_LED#	8	LCPU_LED#
9	LDISKLED#	10	N/A
11	LED_GND	12	LED_GND

**Table 4-9: LED Connector Pinouts (J2)**

#### 4.2.9 PCH Fan Connector (PCH\_FAN)

PIN NO.	DESCRIPTION	PIN NO.	DESCRIPTION
1	GND	2	FANOUT2
3	FANIO2		

**Table 4-10: PCH Fan Connector Pinouts (PCH\_FAN)**

#### 4.2.10 SATA 3Gb/s Drive Connectors (SATA2)

PIN NO.	DESCRIPTION	PIN NO.	DESCRIPTION
1	GND	2	SATA_TX4+
3	SATA_TX4-	4	GND
5	SATA_RX4-	6	SATA_RX4+
7	GND	8	GND
9	SATA_TX5+	10	SATA_TX5-
11	GND	12	SATA_RX5-
13	SATA_RX5+	14	GND

**Table 4-11: SATA 3Gb/s Drive Connectors Pinouts (SATA2)**



#### 4.2.11 SATA Power Connectors (CN2, CN3)

PIN NO.	DESCRIPTION
1	+5V
2	GND

**Table 4-12: SATA Power Connectors Pinouts (CN2, CN3)**

#### 4.2.12 TPM Connector (TPM1)

PIN NO.	DESCRIPTION	PIN NO.	DESCRIPTION
1	TPMPCLK	2	GND
3	LPC_FRAME#		
5	BUF_PCIRST#	6	+5V
7	LPC_AD3	8	LPC_AD2
9	+3.3V	10	LPC_AD1
11	LPC_AD0	12	GND
13	SMBCLK_RESUME	14	SMBDATA_RESUME
15	+3V_DUAL	16	SERIRQ
17	GND	18	+3.3V
19	LPCPD_N	20	LDRQ0#

**Table 4-13: TPM Connector Pinouts (TPM1)**

### 4.3 External Interface Panel Connectors

The table below shows a list of the external interface panel connectors on the system motherboard. Pinouts of these connectors can be found in the following sections.

Connector	Type	Label
Audio jack (mic, line-out)	Audio jack	JAUDIO1
DIO connector	DB-9	DIO1
DisplayPort connector		DISPLAY_PORT1
DVI connector	24-pin female	DVI_I

Connector	Type	Label
Ethernet and USB3.0 connectors	RJ-45, USB 3.0 port	LAN1_USB1, LAN2_USB2
Power connector	4-pin DC jack	PWR1
Power connector	3-pin terminal block	PWR2
RS-232 serial port connectors	DB-9	COM1_2
RS-232/422/485 serial port connectors	DB-9	COM3_4
RS-232 serial port connectors	Dual RJ-45	LANCOM1
USB 2.0 connectors	USB 2.0 port	USB1
VGA connector	DB-15	VGA1

**Table 4-14: Rear Panel Connectors**

#### 4.3.1 Audio Jack (J AUDIO1)

PIN NO.	DESCRIPTION	PIN NO.	DESCRIPTION
1	GND	2	ILMIC1-L
3	GND	4	IMIC1_JD
5	ILMIC1-R	22	ILINE_OUTL
23	GND	24	ISPK_JD
25	ILINE_OUTR		

**Table 4-15: Audio Jack Pinouts (AUDIO1)**

#### 4.3.2 DIO connector (DIO1)

PIN NO.	DESCRIPTION	PIN NO.	DESCRIPTION
1	DIN0	2	DOUT0
3	DIN1	4	DOUT1
5	DIN2	6	DOUT2
7	DIN3	8	DOUT3
9	+5V		

**Table 4-16: DIO connector Pinouts (DIO1)**

### 4.3.3 DisplayPort connector (DISPLAY\_PORT1)

PIN NO.	DESCRIPTION	PIN NO.	DESCRIPTION
1	DPD_OB_LANE0_P	2	GND
3	DPD_OB_LANE0_N	4	DPD_OB_LANE1_P
5	GND	6	DPD_OB_LANE1_N
7	DPD_OB_LANE2_P	8	GND
9	DPD_OB_LANE2_N	10	DPD_OB_LANE3_P
11	GND	12	DPD_OB_LANE3_N
13	GND	14	GND
15	DPD_AUX_CTRL_P2	16	GND
17	DPD_AUX_CTRL_N2	18	DDI1_HPD#
19	GND	20	+3.3V

**Table 4-17: DisplayPort connector Pinouts (DISPLAY\_PORT1)**

### 4.3.4 DVI Connector (DVI\_1)

PIN NO.	DESCRIPTION	PIN NO.	DESCRIPTION
1	DVI_TMDS_C_DATA2#	15	GND
2	DVI_TMDS_C_DATA2	16	DVI_HPD
3	GND	17	DVI_TMDS_C_DATA0#
4	NC	18	DVI_TMDS_C_DATA0
5	NC	19	GND
6	DVI_DDC_SCLK	20	NC
7	DVI_DDC_SDATA	21	NC
8	VSYNC	22	GND
9	DVI_TMDS_C_DATA1#	23	DVI_TMDS_C_CLK
10	DVI_TMDS_C_DATA1	24	DVI_TMDS_C_CLK#
11	GND	C1	RED
12	NC	C2	GREEN
13	NC	C3	BLUE
14	+5V_DVI	C4	HSYNC

**Table 4-18: DVI Connector Pinouts (DVI\_I)**

#### 4.3.5 Ethernet and USB3.0 Connectors (LAN1\_USB1)

PIN NO.	DESCRIPTION	PIN NO.	DESCRIPTION
1	USB3_PWR1	2	USB2P0_DM1
3	USB2P0_DP1	4	GND
5	USB3P0_RXDN1	6	USB3P0_RXDP1
7	GND	8	USB3P0_TXDN1
9	USB3P0_TXDP1	10	USB3_PWR1
11	USB2P0_DM2	12	USB2P0_DP2
13	GND	14	USB3P0_RXDN2
15	USB3P0_RXDP2	16	GND
17	USB3P0_TXDN2	18	USB3P0_TXDP2
19	+0.9V_LAN1	20	LAN1_MDIP0
21	LAN1_MDIN0	22	LAN1_MDIP1
23	LAN1_MDIN1	24	LAN1_MDIP2
25	LAN1_MDN2	26	LAN1_MDIP3
27	LAN1_MDIN3	28	GND
29	+3.3V_LAN1	30	LAN1_LINK_ACT#
31	LAN1_100#	32	LAN1_1000#

**Table 4-19: Ethernet and USB3.0 Connectors Pinouts (LAN1\_USB1)**

#### 4.3.6 Ethernet and USB3.0 Connectors (LAN2\_USB2)

PIN NO.	DESCRIPTION	PIN NO.	DESCRIPTION
1	USB3_PWR2	2	USB2P0_DM3
3	USB2P0_DP3	4	GND
5	USB3P0_RXDN3	6	USB3P0_RXDP3
7	GND	8	USB3P0_TXDN3
9	USB3P0_TXDP3	10	USB3_PWR2
11	USB2P0_DM4	12	USB2P0_DP4
13	GND	14	USB3P0_RXDN4
15	USB3P0_RXDP4	16	GND
17	USB3P0_TXDN4	18	USB3P0_TXDP4
19	+1.5V_LAN2	20	LAN2_MDIP0

## TANK-860-HM86 Embedded System

21	LAN2_MDINO	22	LAN2_MDIP1
23	LAN2_MDIN1	24	LAN2_MDIP2
25	LAN2_MDN2	26	LAN2_MDIP3
27	LAN2_MDIN3	28	GND
29	+3.3V_LAN2	30	LAN2_LINK_ACT#
31	LAN2_100#	32	LAN2_1000#

**Table 4-20: Ethernet and USB3.0 Connectors Pinouts (LAN2\_USB2)**

### 4.3.7 Power Connector (PWR1)

PIN NO.	DESCRIPTION	PIN NO.	DESCRIPTION
1	+VIN	2	GND
3	+VIN	4	GND
5	GND		

**Table 4-21: Power Connector Pinouts (PWR2)**

### 4.3.8 Power Connector (PWR2)

PIN NO.	DESCRIPTION	PIN NO.	DESCRIPTION
1	ACCON	2	+VIN
3	GND		

**Table 4-22: Power Connector Pinouts (PWR1)**

### 4.3.9 RS-232 Serial Port Connector (COM1\_2)

PIN NO.	DESCRIPTION	PIN NO.	DESCRIPTION
1	NDCD1#	2	NRXD1
3	NTXD1	4	NDTR1#
5	GND	6	NDSR1#
7	NRTS1#	8	NCTS1#
9	NR11#	10	NDCD2#
11	NRXD2	12	NTXD2
13	NDTR2#	14	GND
15	NDSR2#	16	NRTS2#



17	NCTS2#	18	NRI2#
----	--------	----	-------

**Table 4-23: RS-232 Serial Port Connector Pinouts (COM1\_2)**

4.3.10 RS-232/422/485 Serial Port Connector (COM3\_4)

PIN NO.	DESCRIPTION	PIN NO.	DESCRIPTION
1	NDCD3/RX+	2	NRXD3/RX-
3	NTXD3/TX+	4	NDTR3/TX-
5	GND	6	NDSR3
7	NRTS3	8	NCTS3
9	NRI3	10	NDCD4/RX+
11	NRXD4/RX-	12	NTXD4/TX+
13	NDTR4/TX-	14	GND
15	NDSR4	16	NRTS4
17	NCTS4	18	NRI4

**Table 4-24: RS-232/422/485 Serial Port Connector Pinouts (COM3\_4)**

4.3.11 RS-232 Serial Port Connectors (LANCOM1)

PIN NO.	DESCRIPTION	PIN NO.	DESCRIPTION
A1	NRI5	A2	NDTR5
A3	NCTS5	A4	NTXD5
A5	NRTS5	A6	NRXD5
A7	NDSR5	A8	NDCD5
B1	NRI6	B2	NDTR6
B3	NCTS6	B4	NTXD6
B5	NRTS6	B6	NRXD6
B7	NDSR6	B8	NDCD6

**Table 4-25: RS-232 Serial Port Connectors Pinouts (LANCOM1)**

4.3.12 USB 2.0 Connectors (USB1)

PIN NO.	DESCRIPTION	PIN NO.	DESCRIPTION
1	+5V	2	GND

## TANK-860-HM86 Embedded System

3	USB20_C_N10	4	USB20_C_P11
5	USB20_C_P10	6	USB20_C_N11
7	GND	8	+5V

**Table 4-26: USB 2.0 Connectors Pinouts (USB1)**

### 4.3.13 VGA Connector (VGA1)

PIN NO.	DESCRIPTION	PIN NO.	DESCRIPTION
1	Red	2	Green
3	Blue	4	NC
5	GND	6	GND
7	GND	8	GND
9	VGAVCC	10	HOTPLUG
11	NC	12	DDCDAT
13	HSYNC	14	VSYNC
15	DDCCLK		

**Table 4-27: VGA Connector Pinouts (VGA1)**

Chapter

5

**BIOS**

---

## 5.1 Introduction

The BIOS is programmed onto the BIOS chip. The BIOS setup program allows changes to certain system settings. This chapter outlines the options that can be changed.



### NOTE:

Some of the BIOS options may vary throughout the life cycle of the product and are subject to change without prior notice.

### 5.1.1 Starting Setup

The UEFI BIOS is activated when the computer is turned on. The setup program can be activated in one of two ways.

1. Press the **DEL** or **F2** key as soon as the system is turned on or
2. Press the **DEL** or **F2** key when the “**Press DEL or F2 to enter SETUP**” message appears on the screen.

If the message disappears before the **DEL** or **F2** key is pressed, restart the computer and try again.

### 5.1.2 Using Setup

Use the arrow keys to highlight items, press **ENTER** to select, use the PageUp and PageDown keys to change entries, press **F1** for help and press **ESC** to quit. Navigation keys are shown in.

Key	Function
Up arrow	Move to previous item
Down arrow	Move to next item
Left arrow	Move to the item on the left hand side
Right arrow	Move to the item on the right hand side
+	Increase the numeric value or make changes

Key	Function
-	Decrease the numeric value or make changes
Page Up key	Increase the numeric value or make changes
Page Dn key	Decrease the numeric value or make changes
Esc key	Main Menu – Quit and not save changes into CMOS Status Page Setup Menu and Option Page Setup Menu -- Exit current page and return to Main Menu
F1	General help, only for Status Page Setup Menu and Option Page Setup Menu
F2	Previous values
F3	Load optimized defaults
F4	Save changes and Exit BIOS

**Table 5-1: BIOS Navigation Keys**

### 5.1.3 Getting Help

When **F1** is pressed a small help window describing the appropriate keys to use and the possible selections for the highlighted item appears. To exit the Help Window press **Esc** or the **F1** key again.

### 5.1.4 Unable to Reboot after Configuration Changes

If the computer cannot boot after changes to the system configuration is made, CMOS defaults. Use the jumper described in Chapter 2.

### 5.1.5 BIOS Menu Bar

The **menu bar** on top of the BIOS screen has the following main items:

- Main – Changes the basic system configuration.
- Advanced – Changes the advanced system settings.
- Chipset – Changes the chipset settings.
- Boot – Changes the system boot configuration.
- Security – Sets User and Supervisor Passwords.



## TANK-860-HM86 Embedded System

- Save & Exit – Selects exit options and loads default settings.

The following sections completely describe the configuration options found in the menu items at the top of the BIOS screen and listed above.

## 5.2 Main

The **Main** BIOS menu (**BIOS Menu 1**) appears when the **BIOS Setup** program is entered.

The **Main** menu gives an overview of the basic system information.

Aptio Setup Utility - Copyright (C) 2011 American Megatrends, Inc.					
Main	Advanced	Chipset	Boot	Security	Save & Exit
BIOS Information					
BIOS Vendor	American Megatrends			Set the Date. Use Tab to switch between Data elements.	
Core Version	4.6.5.4				
Compliancy	UEFI 2.3.1; PI 1.2				
Project Version	SED7AR10.bin				
Build Date	08/11/2014 12:38:08				
iWDD Vendor	iEi				
iWDD Version	SED7ER10.BIN				
IPMI Card Status	Not Present				
Processor Information					
Name	Haswell				
Brand String	Intel(R) Core(TM) i5-4400E CPU @ 2.70GHz				
Frequency	3200 MHz				
Processor ID	306c3				
Stepping	C0				
Number of Processors	2Core(s) / 4Thread(s)				
Microcode Revision	12				
GT Info	GT2 (800 MHz)				
IGFX VBIOS Version	2178				
Memory RC Version	1.6.1.2				
Total Memory	4096 MB (DDR3)				
Memory Frequency	1333 MHz			-----	
PCH Information					
Name	LynxPoint			←→: Select Screen	
PCH SKU	HM86			↑ ↓: Select Item	
Stepping	05/C2			EnterSelect	
LAN PHY Revision	A3			+/-: Change Opt.	
ME FW Version	9.0.13.1402			F1: General Help	
ME Firmware SKU	1.5MB			F2: Previous Values	
SPI Clock Frequency				F3: Optimized Defaults	
DOFR Support	Supported			F4: Save & Exit	
Read Status Clock Frequency	50 MHz			ESC: Exit	
Write Status Clock Frequency	50 MHz				
Fast Read Status Clock Frequency	50 MHz				
System Date	[Wed 104/09/2014]				
System Time	[15:43:27]				
Access Level	Administrator				

### BIOS Menu 1: Main

The Main menu lists the following system details:

- BIOS Information
- Processor Information
- Memory Information
- PCH Information
- SPI Clock Frequency

The Main menu has two user configurable fields:

➔ System Date [xx/xx/xx]

Use the **System Date** option to set the system date. Manually enter the day, month and year.

➔ System Time [xx:xx:xx]

Use the **System Time** option to set the system time. Manually enter the hours, minutes and seconds.

## 5.3 Advanced

Use the **Advanced** menu (**BIOS Menu 2**) to configure the CPU and peripheral devices through the following sub-menus:



### WARNING!

Setting the wrong values in the sections below may cause the system to malfunction. Make sure that the settings made are compatible with the hardware.

---

```

Aptio Setup Utility - Copyright (C) 2011 American Megatrends, Inc.
Main  Advanced  Chipset  Boot  Security  Save & Exit
-----
> ACPI Settings
> RTC Wake Settings
> Trusted Computing
> CPU Configuration
> SATA Configuration
> Intel(R)Rapid Start Technology
> USB Configuration
> F81866 Super IO Configuration
> F81866 H/M Monitor
> Serial Port Console Redirection
> iEi Feature

System ACPI Parameters
-----
<=>: Select Screen
↑↓: Select Item
EnterSelect
+/-: Change Opt.
F1: General Help
F2: Previous Values
F3: Optimized Defaults
F4: Save & Exit
ESC: Exit

Version 2.14.1219. Copyright (C) 2011 American Megatrends, Inc.
    
```

**BIOS Menu 2: Advanced**

5.3.1 ACPI Settings

The **ACPI Settings** menu (**BIOS Menu 3**) configures the Advanced Configuration and Power Interface (ACPI) options.

```

Aptio Setup Utility - Copyright (C) 2011 American Megatrends, Inc.
Advanced
-----
ACPI Settings
ACPI Sleep State          [S1 (CPU Stop Clock)]

Select ACPI sleep state
the system will enter
when the SUSPEND button
is pressed.
-----
<=>: Select Screen
↑↓: Select Item
EnterSelect
+/-: Change Opt.
F1: General Help
F2: Previous Values
F3: Optimized Defaults
F4: Save & Exit
ESC: Exit

Version 2.14.1219. Copyright (C) 2011 American Megatrends, Inc.
    
```

**BIOS Menu 3: ACPI Configuration**

## TANK-860-HM86 Embedded System

### → ACPI Sleep State [S1 (CPU Stop Clock)]

Use the **ACPI Sleep State** option to specify the sleep state the system enters when it is not being used.

- **S1 (CPU Stop Clock)** **DEFAULT** The system enters S1(POS) sleep state. The system appears off. The CPU is stopped; RAM is refreshed; the system is running in a low power mode.
- **S3 (Suspend to RAM)** The caches are flushed and the CPU is powered off. Power to the RAM is maintained. The computer returns slower to a working state, but more power is saved.

### 5.3.2 RTC Wake Settings

The **RTC Wake Settings** menu (**BIOS Menu 4**) configures RTC wake event.

```

Aptio Setup Utility - Copyright (C) 2011 American Megatrends, Inc.
  Advanced
Wake system with Fixed Time      [Disabled]
                                     Enable or disable System
                                     wake on alarm event. When
                                     enabled, System will
                                     wake on the date:: hr::
                                     min::sec specified
-----
<=>: Select Screen
↑↓: Select Item
Enter>Select
+/-: Change Opt.
F1:  General Help
F2:  Previous Values
F3:  Optimized Defaults
F4:  Save & Exit
ESC: Exit
Version 2.14.1219. Copyright (C) 2011 American Megatrends, Inc.

```

**BIOS Menu 4: RTC Wake Settings**



→ Wake System with Fixed Time [Disabled]

Use the **Wake System with Fixed Time** option to specify the time the system should be roused from a suspended state.

→ **Disabled**      **DEFAULT**      The real time clock (RTC) cannot generate a wake event

→ **Enabled**      If selected, the following appears with values that can be selected:

\*Wake up every day

\*Wake up date

\*Wake up hour

\*Wake up minute

\*Wake up second

After setting the alarm, the computer turns itself on from a suspend state when the alarm goes off.

### 5.3.3 Trusted Computing

Use the **Trusted Computing** menu (**BIOS Menu 5**) to configure settings related to the Trusted Computing Group (TCG) Trusted Platform Module (TPM).

## TANK-860-HM86 Embedded System

```

Aptio Setup Utility - Copyright (C) 2011 American Megatrends, Inc.
  Advanced
Configuration
  Security Device Support          [Disable]
Current Status Information
  NO Security Device Found
-----
<->: Select Screen
↑ ↓: Select Item
Enter>Select
+/-: Change Opt.
F1:  General Help
F2:  Previous Values
F3:  Optimized Defaults
F4:  Save & Exit
ESC: Exit
Version 2.14.1219. Copyright (C) 2011 American Megatrends, Inc.
  
```

### BIOS Menu 5: TPM Configuration

➔ Security Device Support [Disable]

Use the **Security Device Support** option to configure support for the security device.

➔ **Disable** **DEFAULT** Security device support is disabled.

➔ **Enable** Security device support is enabled.

### 5.3.4 CPU Configuration

Use the **CPU Configuration** menu (**BIOS Menu 6**) to enter the **CPU Information** submenu or enable Intel Virtualization Technology.

```

Aptio Setup Utility - Copyright (C) 2011 American Megatrends, Inc.
  Advanced
CPU Configuration

Intel(R) Core(TM) i5-4400E CPU @ 2.70GHz
CPU Signature          306c3
Processor Family      6
Microcode Patch       12
FSB Speed             100 MHz
Max CPU Speed         2700 MHz
Min CPU Speed         800 MHz
CPU Speed             3200 MHz
Processor Cores       2
Intel HT Technology   Supported
Intel VT-x Technology Supported
Intel SMX Technology  Supported
64-bit               Supported
EIST Technology       Supported
CPU C3 Technology     Supported
CPU C6 Technology     Supported
CPU C7 Technology     Supported

L1 Data Cache        32 kB x 2
L1 Code Cache        32 kB x 2
L2 Cache             256 kB x 2
L3 Cache             3072 kB

Hyper-threading      [Enabled]
Active Processor Cores [All]
Intel Virtualization Technology [Disabled]
EIST                  [Enabled]
Intel TXT(LT) Support [Disabled]

-----
<=>: Select Screen
↑ ↓: Select Item
EnterSelect
+/-: Change Opt.
F1: General Help
F2: Previous Values
F3: Optimized Defaults
F4: Save & Exit
ESC: Exit

Version 2.14.1219. Copyright (C) 2011 American Megatrends, Inc.
  
```

### BIOS Menu 6: CPU Configuration

The CPU Configuration menu (**BIOS Menu 6**) lists the following CPU details:

- Processor Type: Lists the brand name of the CPU being used
- CPU Signature: Lists the CPU signature value.
- Processor Family: Lists the processor family value.
- Microcode Patch: Lists the microcode patch being used.
- FSB Speed: Lists the FSB speed.
- Max CPU Speed: Lists the maximum CPU processing speed.
- Min CPU Speed: Lists the minimum CPU processing speed.
- CPU Speed: Lists the CPU processing speed.
- Processor Cores: Lists the number of the processor core

## TANK-860-HM86 Embedded System

- Intel HT Technology: Indicates if Intel HT Technology is supported by the CPU.
- Intel VT-x Technology: Indicates if Intel VT-x Technology is supported by the CPU.
- Intel SMX Technology: Indicates if Intel SMX Technology is supported by the CPU.
- 64-bit: Indicates if 64-bit is supported by the CPU.
- EIST Technology: Indicates if EIST Technology is supported by the CPU.
- CPU C3 state: Indicates if C3 state is supported by the CPU.
- CPU C6 state: Indicates if C6 state is supported by the CPU.
- CPU C7 state: Indicates if C7 state is supported by the CPU.
- L1 Data Cache: Lists the amount of data storage space on the L1 cache.
- L1 Code Cache: Lists the amount of code storage space on the L1 cache.
- L2 Cache: Lists the amount of storage space on the L2 cache.
- L3 Cache: Lists the amount of storage space on the L3 cache.

➔ Hyper-threading [Enabled]

Use the **Hyper-threading** BIOS option to enable or disable the Intel Hyper-Threading Technology.

➔ **Disabled**                      Disables the Intel Hyper-Threading Technology.

➔ **Enabled**    **DEFAULT**      Enables the Intel Hyper-Threading Technology.

➔ Active Processor Cores [All]

Use the **Active Processor Cores** option to configure the number of the active processor cores.

➔ **All**                      **DEFAULT**      Active all of the processor cores

➔ **1**                              Active one of the processor cores

➔ **2**                              Active two of the processor cores

➔ **3**                              Active three of the processor cores

→ Intel Virtualization Technology [Disabled]

Use the **Intel Virtualization Technology** option to enable or disable virtualization on the system. When combined with third party software, Intel Virtualization technology allows several OSs to run on the same system at the same time.

→ **Disabled**                      **DEFAULT**      Disables Intel Virtualization Technology.

→ **Enabled**    Enables Intel Virtualization Technology.

→ EIST [Enabled]

Use the **EIST** option to enable or disable the Intel Speed Step Technology.

→ **Disabled**                      Disables the Intel Speed Step Technology.

→ **Enabled**      **DEFAULT**      Enables the Intel Speed Step Technology.

→ Intel TXT(LT) Support [Disabled]

Use the **Intel TXT(LT) Support** option to enable or disable the Intel® Trusted Execution Technology.

→ **Disabled**                      Disables the Intel® Trusted Execution Technology.

→ **Enabled**      **DEFAULT**      Enables the Intel® Trusted Execution Technology.



## TANK-860-HM86 Embedded System

### 5.3.5 SATA Configuration

Use the **SATA Configuration** menu (**BIOS Menu 7**) to change and/or set the configuration of the SATA devices installed in the system.

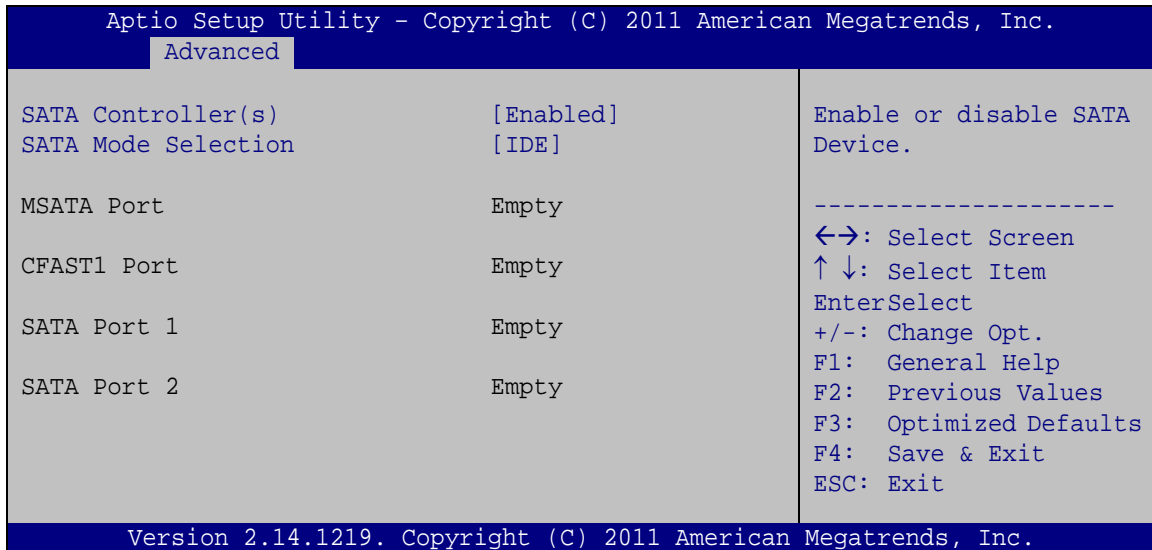

#### BIOS Menu 7: IDE Configuration

##### → SATA Controller(s) [Enabled]

Use the **SATA Controller(s)** option to configure the serial ATA controller.

- **Enabled**      **DEFAULT**      Enables the on-board SATA controller.
- **Disabled**                      Disables the on-board SATA controller.

##### → SATA Mode Selection [IDE]

Use the **SATA Selection Mode** option to configure SATA devices as normal IDE devices.

- **IDE**      **DEFAULT**      Configures SATA devices as normal IDE device.
- **AHCI**                      Configures SATA devices as AHCI device.

### 5.3.6 Intel(R) Rapid Start Technology

Use the **Intel(R) Rapid Start Technology** menu (**BIOS Menu 8**) to configure Intel® Rapid Start Technology support.

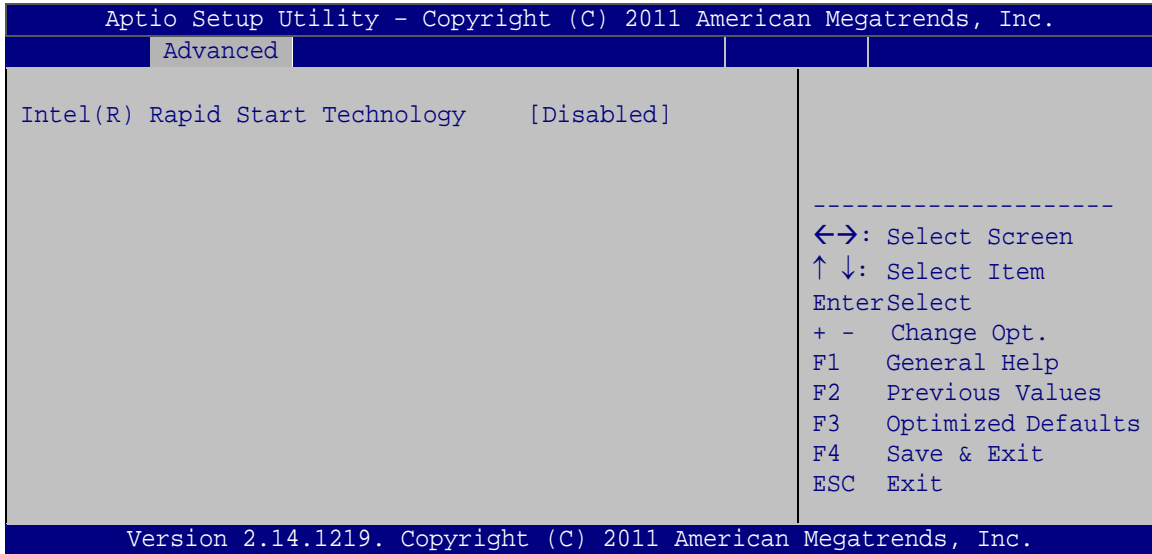

**BIOS Menu 8: Intel(R) Rapid Start Technology**

→ Intel(R) Rapid Start Technology [Disabled]

Use **Intel(R) Rapid Start Technology** option to configure Intel® Rapid Start Technology function.

- **Disabled**      **DEFAULT**      Intel® Rapid Start Technology is disabled
- **Enabled**                      Intel® Rapid Start Technology is enabled

## TANK-860-HM86 Embedded System

### 5.3.7 USB Configuration

Use the **USB Configuration** menu (**BIOS Menu 9**) to read USB configuration information and configure the USB settings.

```

Aptio Setup Utility - Copyright (C) 2011 American Megatrends, Inc.
  Advanced
USB Configuration
USB Devices:
  1 Keyboard
Legacy USB Support          [Enabled]
-----
<=>: Select Screen
↑↓: Select Item
Enter>Select
+/-: Change Opt.
F1: General Help
F2: Previous Values
F3: Optimized Defaults
F4: Save & Exit
ESC: Exit
Version 2.14.1219. Copyright (C) 2011 American Megatrends, Inc.
  
```

#### BIOS Menu 9: USB Configuration

##### ➔ USB Devices

The **USB Devices** field lists the USB devices that are enabled on the system

##### ➔ Legacy USB Support [Enabled]

Use the **Legacy USB Support** BIOS option to enable USB mouse and USB keyboard support. Normally if this option is not enabled, any attached USB mouse or USB keyboard does not become available until a USB compatible operating system is fully booted with all USB drivers loaded. When this option is enabled, any attached USB mouse or USB keyboard can control the system even when there is no USB driver loaded onto the system.

➔ **Enabled**      **DEFAULT**      Legacy USB support enabled

- ➔ **Disabled** Legacy USB support disabled
- ➔ **Auto** Legacy USB support disabled if no USB devices are connected

### 5.3.8 F81866 Super IO Configuration

Use the **F81866 Super IO Configuration** menu (**BIOS Menu 10**) to set or change the configurations for the serial ports.

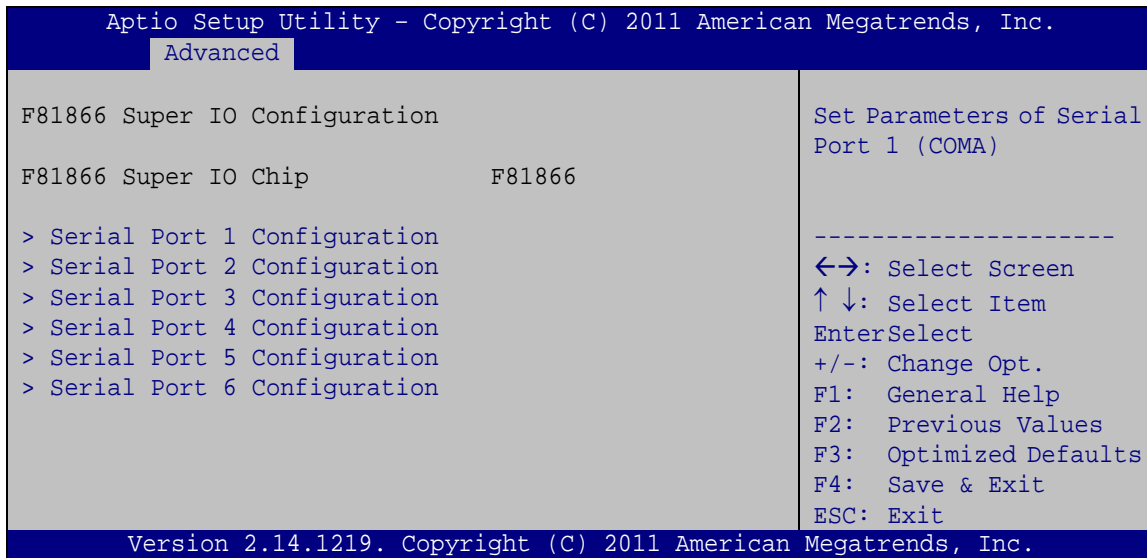

**BIOS Menu 10: F81866 Super IO Configuration**

## TANK-860-HM86 Embedded System

### 5.3.8.1 Serial Port n Configuration

Use the **Serial Port n Configuration** menu (**BIOS Menu 11**) to configure the serial port n.

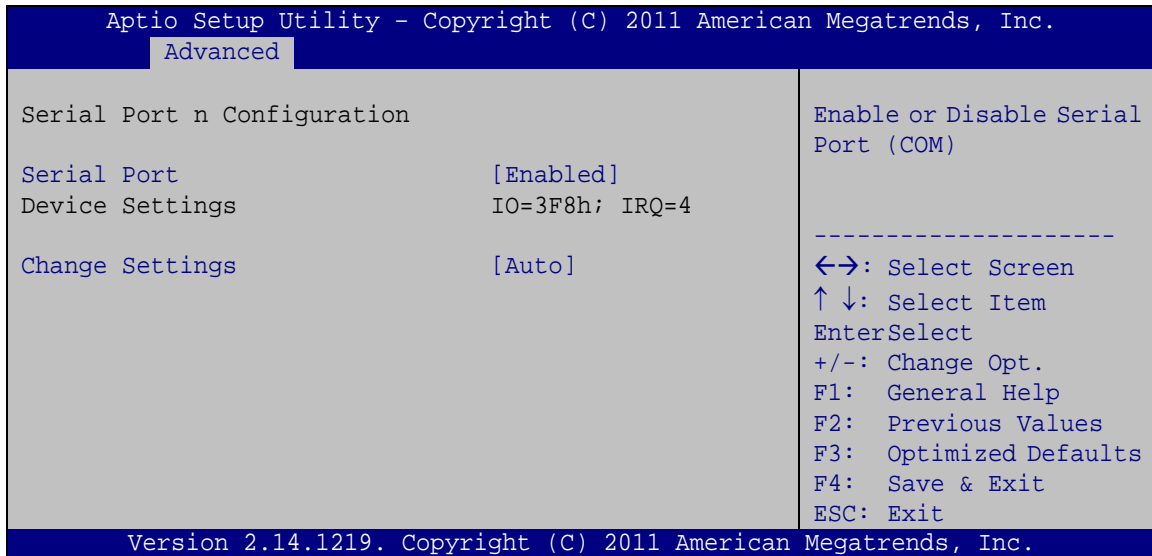

#### BIOS Menu 11: Serial Port n Configuration Menu

##### 5.3.8.1.1 Serial Port 1 Configuration

###### → Serial Port [Enabled]

Use the **Serial Port** option to enable or disable the serial port.

- **Disabled** Disable the serial port
- **Enabled** **DEFAULT** Enable the serial port

###### → Change Settings [Auto]

Use the **Change Settings** option to change the serial port IO port address and interrupt address.

- **Auto** **DEFAULT** The serial port IO port address and interrupt address are automatically detected.
- **IO=3F8h;**  
**IRQ=4** Serial Port I/O port address is 3F8h and the interrupt address is IRQ4



- ➔ **IO=3F8h;**                      Serial Port I/O port address is 3F8h and the interrupt  
**IRQ=3, 4**                      address is IRQ3, 4
- ➔ **IO=2F8h;**                      Serial Port I/O port address is 2F8h and the interrupt  
**IRQ=3, 4**                      address is IRQ3, 4

### 5.3.8.1.2 Serial Port 2 Configuration

- ➔ Serial Port [Enabled]

Use the **Serial Port** option to enable or disable the serial port.

- ➔ **Disabled**                      Disable the serial port
- ➔ **Enabled**                      **DEFAULT**                      Enable the serial port

- ➔ Change Settings [Auto]

Use the **Change Settings** option to change the serial port IO port address and interrupt address.

- ➔ **Auto**                      **DEFAULT**                      The serial port IO port address and interrupt address  
are automatically detected.
- ➔ **IO=2F8h;**                      Serial Port I/O port address is 2F8h and the interrupt  
**IRQ=3**                      address is IRQ3
- ➔ **IO=3F8h;**                      Serial Port I/O port address is 3F8h and the interrupt  
**IRQ=3, 4**                      address is IRQ3, 4
- ➔ **IO=2F8h;**                      Serial Port I/O port address is 2F8h and the interrupt  
**IRQ=3, 4**                      address is IRQ3, 4

### 5.3.8.1.3 Serial Port 3 Configuration

- ➔ Serial Port [Enabled]

Use the **Serial Port** option to enable or disable the serial port.

- ➔ **Disabled**                      Disable the serial port

## TANK-860-HM86 Embedded System

➔ **Enabled**      **DEFAULT**      Enable the serial port

➔ Change Settings [Auto]

Use the **Change Settings** option to change the serial port IO port address and interrupt address.

➔ **Auto**      **DEFAULT**      The serial port IO port address and interrupt address are automatically detected.

➔ **IO=3E8h;**  
**IRQ=10**      Serial Port I/O port address is 3E8h and the interrupt address is IRQ10

➔ **IO=3E8h;**  
**IRQ=10, 11**      Serial Port I/O port address is 3E8h and the interrupt address is IRQ10, 11

➔ **IO=2E8h;**  
**IRQ=10, 11**      Serial Port I/O port address is 2E8h and the interrupt address is IRQ10, 11

➔ Device Mode [RS232]

Use the **Device Mode** option to select the serial port mode.

➔ **RS232**      **DEFAULT**      Enables serial port RS-232 support.

➔ **RS422**      Enables serial port RS-422 support.

➔ **RS485**      Enables serial port RS-485 support.

#### 5.3.8.1.4 Serial Port 4 Configuration

➔ Serial Port [Enabled]

Use the **Serial Port** option to enable or disable the serial port.

➔ **Disabled**      Disable the serial port

➔ **Enabled**      **DEFAULT**      Enable the serial port

→ Change Settings [Auto]

Use the **Change Settings** option to change the serial port IO port address and interrupt address.

- **Auto**            **DEFAULT**            The serial port IO port address and interrupt address are automatically detected.
- **IO=2E8h;**  
**IRQ=10**                            Serial Port I/O port address is 2E8h and the interrupt address is IRQ10
- **IO=3E8h;**  
**IRQ=10, 11**                        Serial Port I/O port address is 3E8h and the interrupt address is IRQ10, 11
- **IO=2E8h;**  
**IRQ=10, 11**                        Serial Port I/O port address is 2E8h and the interrupt address is IRQ10, 11

→ Device Mode [RS232]

Use the **Device Mode** option to select the serial port mode.

- **RS232**            **DEFAULT**            Enables serial port RS-232 support.
- **RS422**                            Enables serial port RS-422 support.
- **RS485**                            Enables serial port RS-485 support.

### 5.3.8.1.5 Serial Port 5 Configuration

→ Serial Port [Enabled]

Use the **Serial Port** option to enable or disable the serial port.

- **Disabled**                            Disable the serial port
- **Enabled**            **DEFAULT**            Enable the serial port

→ Change Settings [Auto]

Use the **Change Settings** option to change the serial port IO port address and interrupt address.

## TANK-860-HM86 Embedded System

- ➔ **Auto**      **DEFAULT**      The serial port IO port address and interrupt address are automatically detected.
- ➔ **IO=2D0h;**  
**IRQ=10**      Serial Port I/O port address is 2D0h and the interrupt address is IRQ10
- ➔ **IO=2D0h;**  
**IRQ=10, 11**      Serial Port I/O port address is 2D0h and the interrupt address is IRQ10, 11
- ➔ **IO=2D8h;**  
**IRQ=10, 11**      Serial Port I/O port address is 2D8h and the interrupt address is IRQ10, 11

### 5.3.8.1.6 Serial Port 6 Configuration

#### ➔ Serial Port [Enabled]

Use the **Serial Port** option to enable or disable the serial port.

- ➔ **Disabled**      Disable the serial port
- ➔ **Enabled**      **DEFAULT**      Enable the serial port

#### ➔ Change Settings [Auto]

Use the **Change Settings** option to change the serial port IO port address and interrupt address.

- ➔ **Auto**      **DEFAULT**      The serial port IO port address and interrupt address are automatically detected.
- ➔ **IO=2D8h;**  
**IRQ=10**      Serial Port I/O port address is 2D8h and the interrupt address is IRQ10
- ➔ **IO=2D0h;**  
**IRQ=10, 11**      Serial Port I/O port address is 2D0h and the interrupt address is IRQ10, 11
- ➔ **IO=2D8h;**  
**IRQ=10, 11**      Serial Port I/O port address is 2D8h and the interrupt address is IRQ10, 11

### 5.3.9 F81866 H/W Monitor

The **F8186 H/W Monitor** menu (**BIOS Menu 12**) shows the operating temperature, fan speeds and system voltages.

```

Aptio Setup Utility - Copyright (C) 2011 American Megatrends, Inc.
Advanced
PC Health Status
> Smart Fan Mode Configuration
CPU Temperature      :+86 C
System Temperature  :+58 C
CPU_FAN1 Speed      :N/A

Smart Fan Mode Select

-----
<=>: Select Screen
↑↓: Select Item
Enter>Select
+/-: Change Opt.
F1:  General Help
F2:  Previous Values
F3:  Optimized
Defaults
F4:  Save & Exit
ESC: Exit

Version 2.14.1219. Copyright (C) 2011 American Megatrends, Inc.

```

#### BIOS Menu 12: Hardware Health Configuration

##### → PC Health Status

The following system parameters and values are shown. The system parameters that are monitored are:

- System Temperatures:
  - CPU Temperature
  - System Temperature
- Fan Speeds:
  - CPU\_Fan1 Speed

#### 5.3.9.1 Smart Fan Mode Configuration

Use the **Smart Fan Mode Configuration** submenu (**BIOS Menu 13**) to configure the smart fan temperature and speed settings.



## TANK-860-HM86 Embedded System

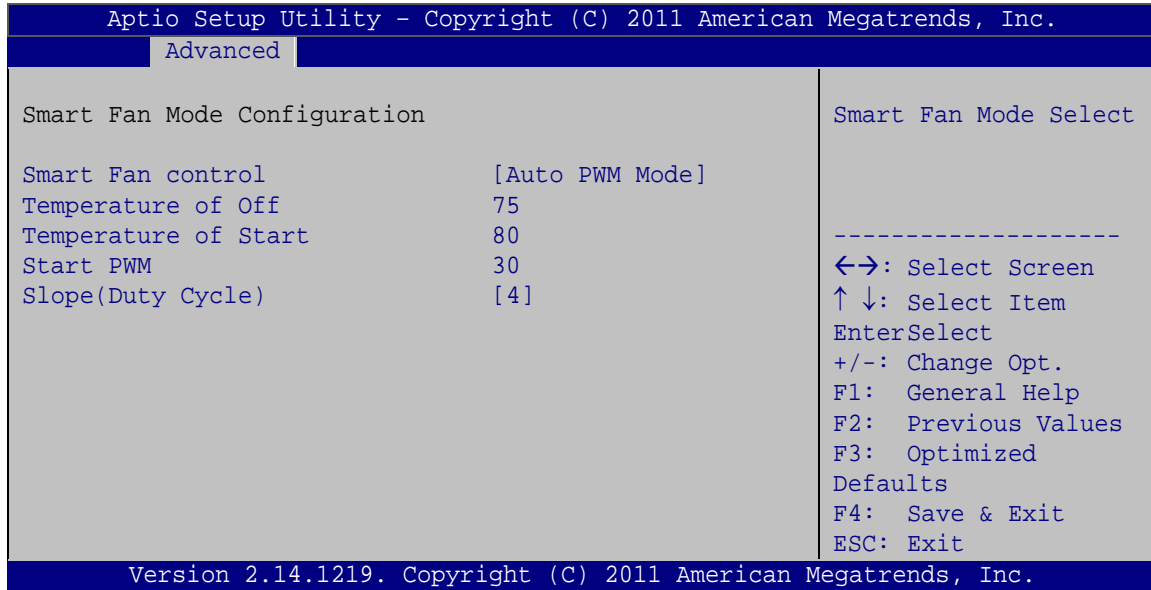

### BIOS Menu 13: FAN Configuration

#### → Smart Fan control [Auto PWM Mode]

Use the **Smart Fan control** BIOS option to configure the CPU Smart Fan.

- **Full Mode** Fan is on all the time
- **Manual PWM Mode** The fan spins at the speed set in the manual setting
- **Auto PWM Mode** **DEFAULT** The fan adjusts its speed using these settings:
  - Temperature of Start
  - Temperature of Off
  - Start PWM
  - Slope (Duty Cycle)

#### → Temperature of Off [75]



#### **WARNING:**

Setting this value too high may cause the fan to speed up only when

---

the CPU is at a very high temperature and therefore cause the system to be damaged.

---

The **Temperature of Off** option can only be set if the **Smart Fan control** option is set to **Auto PWM Mode**. When the **CPU Temperature** is lower than **Temperature of Off**, the fan will be rotate at lowest speed. To set a value, select the **Temperature of Off** option and enter a decimal number between 0 and 127. The temperature range is specified below.

- Minimum Value: 0°C
- Maximum Value: 127°C

→ Temperature of Start [80]

---



**WARNING:**

Setting this value too high may cause the fan to rotate at full speed only when the CPU is at a very high temperature and therefore cause the system to be damaged.

---

The **Temperature of Start** option can only be set if the **Smart Fan control** option is set to **Auto PWM Mode**. Use the **Temperature of Start** option to set the CPU temperature at which the cooling fan starts to rotate using the starting pulse width modulation (PWM) specified in the **Start PWM** option below. To set a value, select the **Temperature of Start** option and enter a decimal number between 0 and 127. The temperature range is specified below.

- Minimum Value: 0°C
- Maximum Value: 127°C

→ Start PWM [30]

The **Start PWM** option can only be set if the **Smart Fan control** option is set to **Auto PWM Mode**. Use the **Start PWM** option to set the PWM start value. To set a value, select

## TANK-860-HM86 Embedded System

the **Start PWM** option and enter a decimal number between 0 and 100. The temperature range is specified below.

- Minimum Value: 0
- Maximum Value: 100

### → Slope (Duty Cycle) [4 (PWM)]

The **Slope (Duty Cycle)** option can only be set if the **Smart Fan control** option is set to **Auto PWM Mode**. Use the **Slope (Duty Cycle)** option to select the linear rate at which the PWM mode increases with respect to an increase in temperature. A list of available options is shown below:

- 0
- 1
- 2
- 4
- 8
- 16

### 5.3.10 Serial Port Console Redirection

The **Serial Port Console Redirection** menu (**BIOS Menu 14**) allows the console redirection options to be configured. Console redirection allows users to maintain a system remotely by re-directing keyboard input and text output through the serial port.



### BIOS Menu 14: Serial Port Console Redirection

➔ Console Redirection [Disabled]

Use **Console Redirection** option to enable or disable the console redirection function.

- ➔ **Disabled**    **DEFAULT**    Disabled the console redirection function
- ➔ **Enabled**                    Enabled the console redirection function

## TANK-860-HM86 Embedded System

### 5.3.10.1 Console Redirection Settings

The **Console Redirection Settings** menu (**BIOS Menu 15**) allows the console redirection options to be configured. The option is active when Console Redirection option is enabled.

```

Aptio Setup Utility - Copyright (C) 2011 American Megatrends, Inc.
  Advanced
COM1
Console Redirection Settings

Terminal Type          [ANSI]
Bits per second       [115200]
Data Bits             [8]
Parity                [None]
Stop Bits             [1]

Emulation: ANSI:
Extended ASCII char set.
VT100: ASCII char set.
VT100+: Extends VT100 to
support color, function
keys, etc. VT-UTF8: Uses
UTF8 encoding to map
Unicode chars onto 1 or
more bytes.

-----
<->: Select Screen
↑ ↓: Select Item
EnterSelect
+/-: Change Opt.
F1:  General Help
F2:  Previous Values
F3:  Optimized
Defaults
F4:  Save & Exit
ESC: Exit

Version 2.14.1219. Copyright (C) 2011 American Megatrends, Inc.
  
```

#### BIOS Menu 15: Console Redirection Settings

➔ Terminal Type [ANSI]

Use the **Terminal Type** option to specify the remote terminal type..

- ➔ **VT100**                      The target terminal type is VT100
- ➔ **VT100+**                    The target terminal type is VT100+
- ➔ **VT-UTF8**                    The target terminal type is VT-UTF8
- ➔ **ANSI**                      **DEFAULT**      The target terminal type is ANSI

➔ Bits per second [115200]

Use the **Bits per second** option to specify the transmission speed of the serial port.





## TANK-860-HM86 Embedded System

- ➔ 1            **DEFAULT**      Sets the number of stop bits at 1.
- ➔ 2                              Sets the number of stop bits at 2.

### 5.3.11 iEi Feature

Use the **iEi Feature** menu (**BIOS Menu 16**) to configure the iEi features.

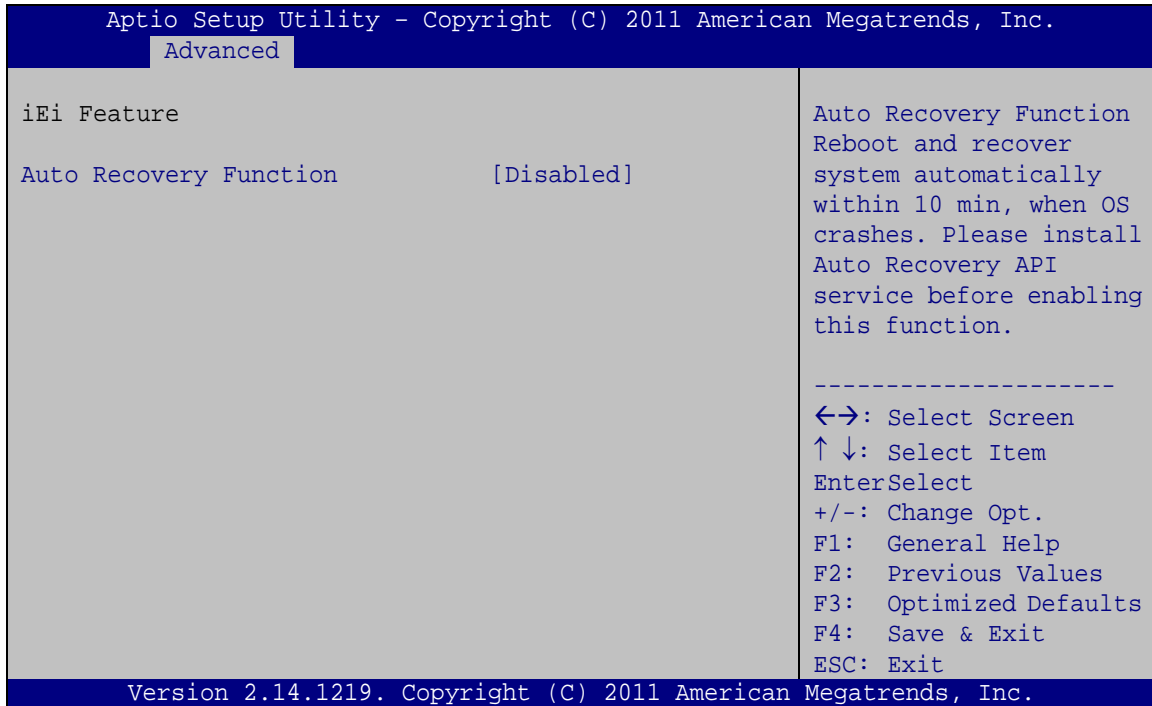

#### BIOS Menu 16: iEi Feature

- ➔ Auto Recovery Function [Disabled]

Use **Auto Recovery Function** option to enable or disable the auto recovery function.

- ➔ **Disabled**      **DEFAULT**      Disabled the auto recovery function
- ➔ **Enabled**                      Enabled the auto recovery function

## 5.4 Chipset

Use the **Chipset** menu (**BIOS Menu 17**) to access the Northbridge and Southbridge configuration menus.



### WARNING!

Setting the wrong values for the Chipset BIOS selections in the Chipset BIOS menu may cause the system to malfunction.

```
Aptio Setup Utility - Copyright (C) 2011 American Megatrends, Inc.
Main   Advanced  Chipset  Boot   Security  Save & Exit
-----
> PCH-IO Configuration          PCH Parameters
> System Agent (SA) Configuration

-----
<=>: Select Screen
↑ ↓: Select Item
EnterSelect
+/-: Change Opt.
F1:  General Help
F2:  Previous Values
F3:  Optimized Defaults
F4:  Save & Exit
ESC: Exit

Version 2.14.1219. Copyright (C) 2011 American Megatrends, Inc.
```

### BIOS Menu 17: Chipset

## TANK-860-HM86 Embedded System

### 5.4.1 PCH-IO Configuration

Use the **PCH-IO Configuration** menu (**BIOS Menu 18**) to configure the PCH parameters.

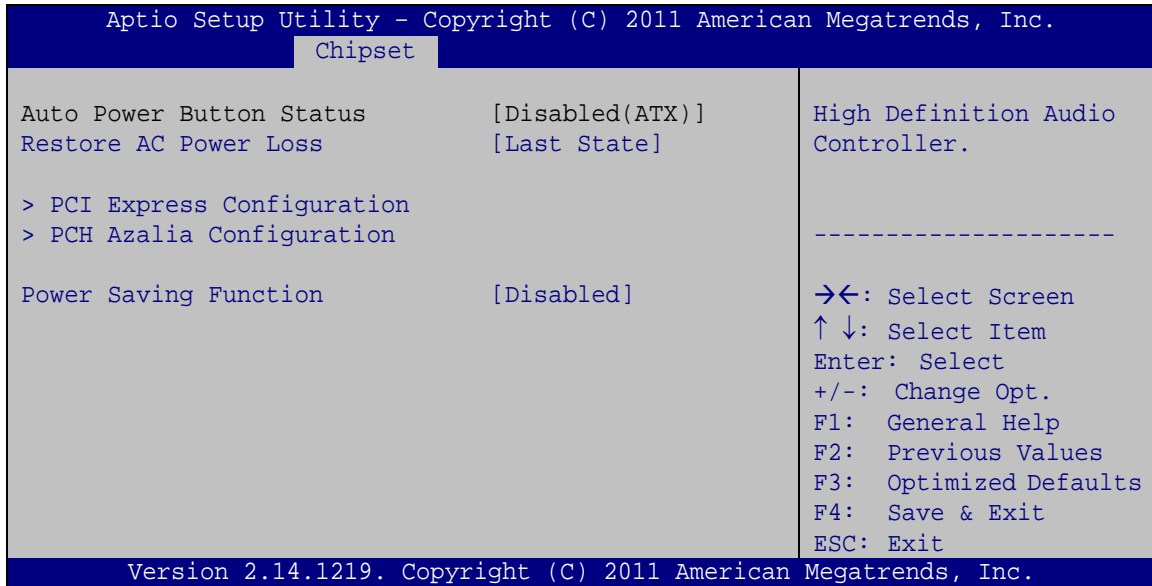

#### BIOS Menu 18: PCH-IO Configuration

##### → Restore AC Power Loss [Last State]

Use the **Restore on AC Power Loss** option to specify what state the system returns to if there is a sudden loss of power to the system.

- **Power Off**                      The system remains turned off
- **Power On**                        The system turns on
- **Last State**    **DEFAULT**    The system returns to its previous state. If it was on, it turns itself on. If it was off, it remains off.

##### → Power Saving Function [Disabled]

Use the **Power Saving Function** BIOS option to enable or disable the power saving function.

- **Disabled**        **DEFAULT**    Power saving function is disabled.
- **Enabled**                            Power saving function is enabled. It will reduce power consumption when the system is off.

### 5.4.1.1 PCIExpress Configuration

Use the **PCI Express Configuration** menu (**BIOS Menu 19**) to select the support type of the PCIe Mini slot.

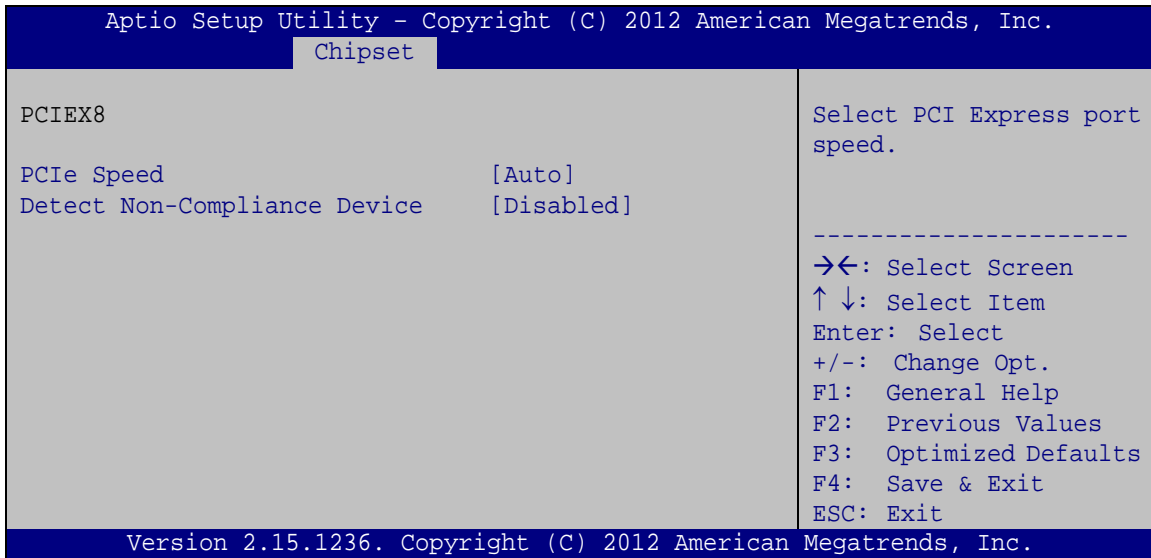

#### BIOS Menu 19: PCI Express Configuration

##### → PCIe Speed

Use PCIe Speed option to select the speed type of the PCIe Mini slot. The following options are available:

- Auto                   **Default**
- Gen1
- Gen2

##### → Detect Non-Compliance Device [Disabled]

Use the **Detect Non-Compliance Device** option to enable or disable the “detect no-compliance PCIe device” function.

→ **Disabled**   **DEFAULT**   Detect no-compliance PCIe device function is disabled

→ **Enabled**                   Detect no-compliance PCIe device function is enabled. If will take more time at POST if it is enabled.



## TANK-860-HM86 Embedded System

### 5.4.1.2 PCH Azalia Configuration

Use the **PCH Azalia Configuration** menu (**BIOS Menu 20**) to configure the PCH Azalia settings.

```

Aptio Setup Utility - Copyright (C) 2012 American Megatrends, Inc.
Main   Advanced  Chipset   Boot   Security  Save & Exit
-----
PCH Azalia Configuration
Azalia HD Audio           [Enabled]

Control Detection of the
Azalia device.
Disabled = Azalia will be
unconditionally
disabled
Enabled = Azalia will be
unconditionally Enabled

-----
-><: Select Screen
↑ ↓: Select Item
Enter: Select
+/-: Change Opt.
F1: General Help
F2: Previous Values
F3: Optimized Defaults
F4: Save & Exit
ESC: Exit

Version 2.15.1236. Copyright (C) 2012 American Megatrends, Inc.
  
```

#### BIOS Menu 20: PCH Azalia Configuration Menu

➔ Azalia HD Audio [Enabled]

Use the **Azalia** option to enable or disable the High Definition Audio controller.

- ➔ **Disabled**                      The onboard High Definition Audio controller is disabled
- ➔ **Enabled    DEFAULT**        The onboard High Definition Audio controller automatically detected and enabled

### 5.4.2 System Agent (SA) Configuration

Use the **System Agent (SA) Configuration** menu (**BIOS Menu 21**) to configure the System Agent (SA) parameters.

```

Aptio Setup Utility - Copyright (C) 2012 American Megatrends, Inc.
Main   Advanced  Chipset   Boot   Security  Save & Exit
  
```

```

VT-d                                [Enabled]                Check to enable VT-d
> Graphics Configuration              function on MCH.
> NB PCIe Configuration
> Memory Configuration

-----
-><: Select Screen
↑↓: Select Item
Enter: Select
+/-: Change Opt.
F1: General Help
F2: Previous Values
F3: Optimized Defaults
F4: Save & Exit
ESC: Exit

Version 2.15.1236. Copyright (C) 2012 American Megatrends, Inc.
  
```

**BIOS Menu 21: System Agent (SA) Configuration**

5.4.2.1 Graphics Configuration

Use the **Graphics Configuration (BIOS Menu 22)** menu to configure the video device connected to the system.

```

Aptio Setup Utility - Copyright (C) 2012 American Megatrends, Inc.
Chipset

Graphics Configuration
Primary Display                [Auto]
DVMT Pre-Allocated            [256M]
DVMT Total Gfx Mem            [MAX]

Primary IGFX Boot Display      [VBIOS Default]

-----
-><: Select Screen
↑↓: Select Item
Enter: Select
+/-: Change Opt.
F1: General Help
F2: Previous Values
F3: Optimized Defaults
F4: Save & Exit
ESC: Exit

Version 2.15.1236. Copyright (C) 2012 American Megatrends, Inc.
  
```

**BIOS Menu 22: Graphics Configuration**

➔ Primary Display [Auto]

Use the **Primary Display** option to select the primary graphics controller the system uses. The following options are available:

## TANK-860-HM86 Embedded System

- Auto                   **Default**
- IGFX
- PEG
- PCIE

## ➔ DVMT Pre-Allocated [256M]

Use the **DVMT Pre-Allocated** option to set the amount of system memory allocated to the integrated graphics processor when the system boots. The system memory allocated can then only be used as graphics memory, and is no longer available to applications or the operating system. Configuration options are listed below:

- 32M
- 64M
- 128M
- 256M                   **Default**
- 512M

## ➔ DVMT Total Gfx Mem [MAX]

Use the **DVMT Total Gfx Mem** option to select DVMT5.0 total graphic memory size used by the internal graphic device. The following options are available:

- 128M
- 256M
- MAX                   **Default**

## ➔ Primary IGFX Boot Display [VBIOS Default]

Use the **Primary IGFX Boot Display** option to select the display device used by the system when it boots. Configuration options are listed below.

- VBIOS Default       **DEFAULT**
- CRT
- Display port 1
- DVI

### 5.4.2.2 NB PCIe Configuration

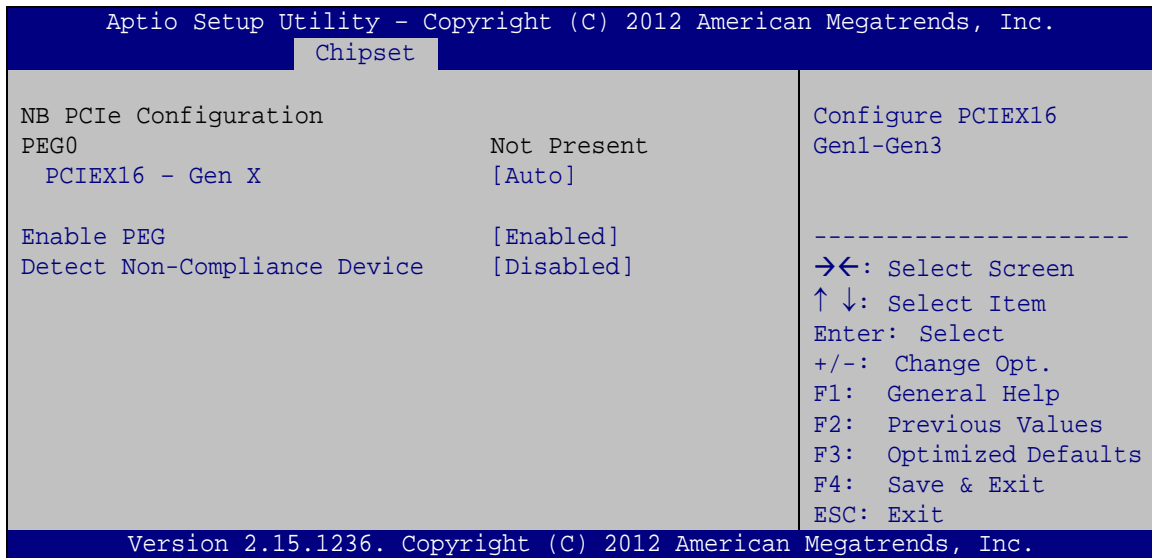

#### BIOS Menu 23: NB PCIe Configuration

##### → PCIEX16 – Gen X [Auto]

Use the **PCIEX16 – Gen X** option to select the support type of the PCI Express x16 slot.

The following options are available:

- Auto                   **Default**
- Gen1
- Gen2
- Gen3

##### → Enable PEG [Auto]

Use the **Enable PEG** option to enable or disable the PCI Express controller. The following options are available:

- Disabled
- Enabled
- Auto                   **Default**

##### → Detect Non-Compliance Device [Disabled]

Use the **Detect Non-Compliance Device** option to enable or disable detecting a non-compliance PCI Express device in the PEG. The following options are available:

## TANK-860-HM86 Embedded System

- Disabled      **Default**
- Enabled

### 5.4.2.3 Memory Configuration

Use the **Memory Configuration** submenu (**BIOS Menu 24**) to view memory information.

```

Aptio Setup Utility - Copyright (C) 2012 American Megatrends, Inc.
Chipset
Memory Information
Memory Frequency          1333 Mhz
Total Memory              4096 MB (DDR3)
DIMM1                     4096 MB (DDR3)
DIMM2                     Not Present
-----
-><: Select Screen
↑↓: Select Item
Enter: Select
+/-: Change Opt.
F1:  General Help
F2:  Previous Values
F3:  Optimized Defaults
F4:  Save & Exit
ESC: Exit
Version 2.15.1236. Copyright (C) 2012 American Megatrends, Inc.
    
```

**BIOS Menu 24: Memory Configuration**



## 5.5 Boot

Use the **Boot** menu (**BIOS Menu 25**) to configure system boot options.

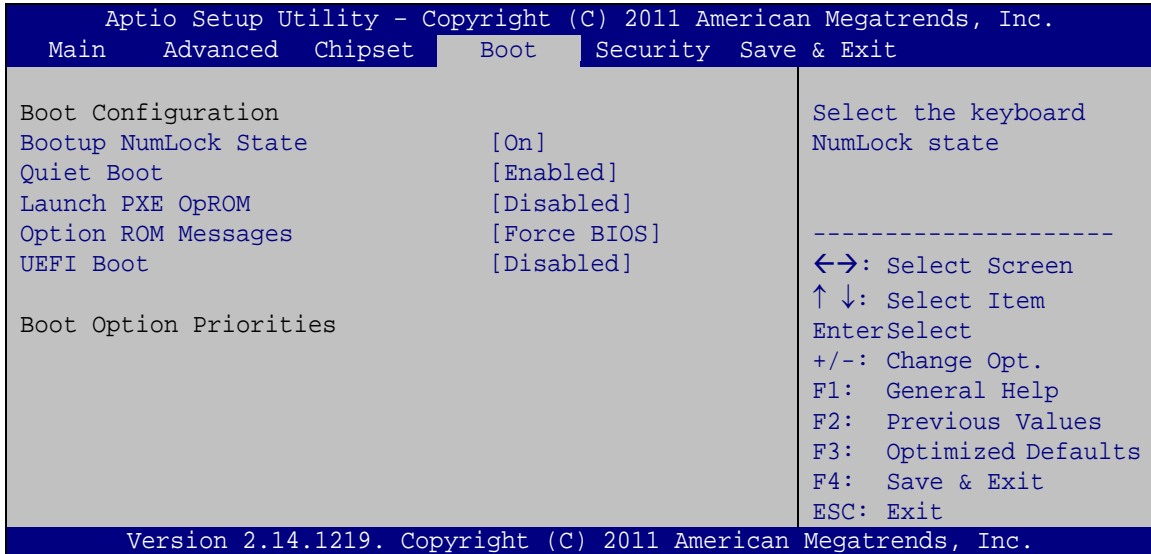

### BIOS Menu 25: Boot

#### → Bootup NumLock State [On]

Use the **Bootup NumLock State** BIOS option to specify if the number lock setting must be modified during boot up.

→ **On**                      **DEFAULT**                      Allows the Number Lock on the keyboard to be enabled automatically when the computer system boots up. This allows the immediate use of the 10-key numeric keypad located on the right side of the keyboard. To confirm this, the Number Lock LED light on the keyboard is lit.

→ **Off**                                      Does not enable the keyboard Number Lock automatically. To use the 10-keys on the keyboard, press the Number Lock key located on the upper left-hand corner of the 10-key pad. The Number Lock LED on the keyboard lights up when the Number Lock is engaged.

## TANK-860-HM86 Embedded System

## → Quiet Boot [Enabled]

Use the **Quiet Boot** BIOS option to select the screen display when the system boots.

- **Disabled** Normal POST messages displayed
- **Enabled** **DEFAULT** OEM Logo displayed instead of POST messages

## → Launch PXE OpROM [Disabled]

Use the **Launch PXE OpROM** option to enable or disable boot option for legacy network devices.

- **Disabled** **DEFAULT** Ignore all PXE Option ROMs
- **Enabled** Load PXE Option ROMs.

## → Option ROM Messages [Force BIOS]

Use the **Option ROM Messages** option to set the Option ROM display mode.

- **Force BIOS** **DEFAULT** Sets display mode to force BIOS.
- **Keep Current** Sets display mode to current.

## → UEFI Boot [Disabled]

Use the **UEFI Boot** option to enable or disable to boot from the UEFI devices.

- **Enabled** Boot from UEFI devices is enabled.
- **Disabled** **DEFAULT** Boot from UEFI devices is disabled.

## 5.6 Security

Use the **Security** menu (**BIOS Menu 26**) to set system and user passwords.

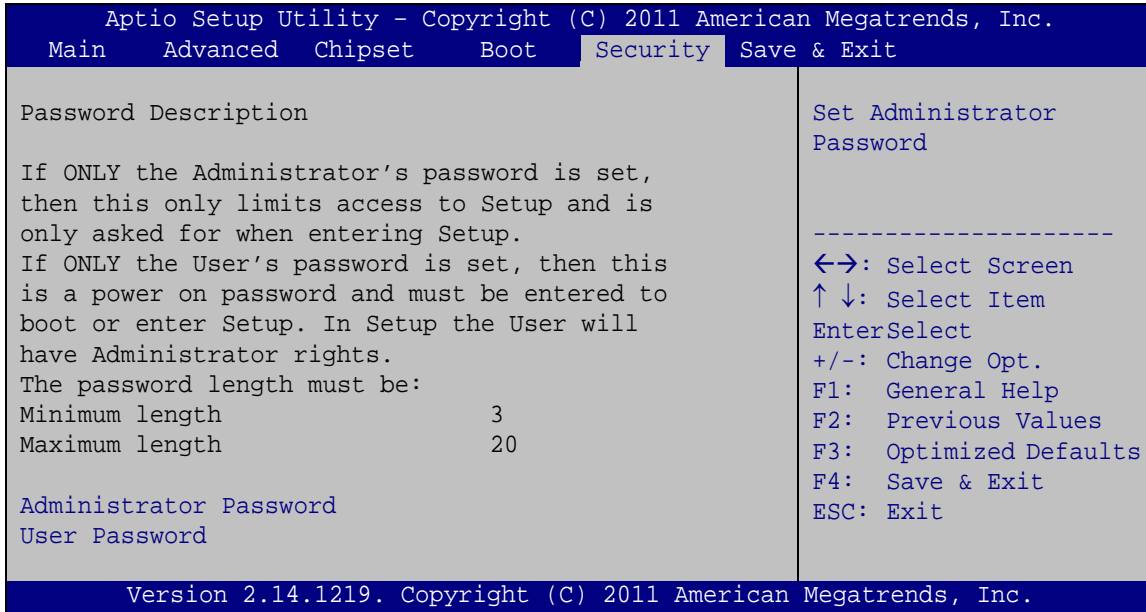

**BIOS Menu 26: Security**

➔ Administrator Password

Use the **Administrator Password** to set or change an administrator password.

➔ User Password

Use the **User Password** to set or change a user password.

## TANK-860-HM86 Embedded System

## 5.7 Exit

Use the **Exit** menu (**BIOS Menu 27**) to load default BIOS values, optimal failsafe values and to save configuration changes.

```

Aptio Setup Utility - Copyright (C) 2011 American Megatrends, Inc.
Main   Advanced  Chipset   Boot     Security  Save & Exit
-----
Save Changes and Reset
Discard Changes and Reset

Restore Defaults
Save as User Defaults
Restore User Defaults

Exit the system after
saving the changes.

-----
<->: Select Screen
↑ ↓: Select Item
Enter>Select
+/-: Change Opt.
F1:  General Help
F2:  Previous Values
F3:  Optimized Defaults
F4:  Save & Exit
ESC: Exit

Version 2.14.1219. Copyright (C) 2011 American Megatrends, Inc.

```

**BIOS Menu 27:Exit**

## ➔ Save Changes and Reset

Use the **Save Changes and Reset** option to save the changes made to the BIOS options and reset the system.

## ➔ Discard Changes and Reset

Use the **Discard Changes and Reset** option to exit the system without saving the changes made to the BIOS configuration setup program.

## ➔ Restore Defaults

Use the **Restore Defaults** option to load the optimal default values for each of the parameters on the Setup menus. **F3 key can be used for this operation.**

➔ Save as User Defaults

Use the **Save as User Defaults** option to save the changes done so far as user defaults.

➔ Restore User Defaults

Use the **Restore User Defaults** option to restore the user defaults to all the setup options.



Appendix

A

# Safety Precautions

---

## A.1 Safety Precautions

---



### WARNING:

The precautions outlined in this appendix should be strictly followed. Failure to follow these precautions may result in permanent damage to the TANK-860-HM86 Series.

---

Please follow the safety precautions outlined in the sections that follow:

### A.1.1 General Safety Precautions

Please ensure the following safety precautions are adhered to at all times.

- ***Make sure the power is turned off and the power cord is disconnected*** when moving, installing or modifying the system.
- ***Do not apply voltage levels that exceed the specified voltage range.*** Doing so may cause fire and/or an electrical shock.
- ***Electric shocks can occur*** if opened while still powered on.
- ***Do not drop or insert any objects*** into the ventilation openings.
- ***If considerable amounts of dust, water, or fluids enter the system***, turn off the power supply immediately, unplug the power cord, and contact the system vendor.
- **DO NOT:**
  - Drop the system against a hard surface.
  - In a site where the ambient temperature exceeds the rated temperature

### A.1.2 Anti-static Precautions

---



### WARNING:

Failure to take ESD precautions during the installation of the TANK-860-HM86 Series may result in permanent damage to the TANK-860-HM86 Series and severe injury to the user.

---

## TANK-860-HM86 Embedded System

Electrostatic discharge (ESD) can cause serious damage to electronic components, including the TANK-860-HM86 Series. Dry climates are especially susceptible to ESD. It is therefore critical that whenever the TANK-860-HM86 Series is opened and any of the electrical components are handled, the following anti-static precautions are strictly adhered to.

- **Wear an anti-static wristband:** Wearing a simple anti-static wristband can help to prevent ESD from damaging any electrical component.
- **Self-grounding:** Before handling any electrical component, touch any grounded conducting material. During the time the electrical component is handled, frequently touch any conducting materials that are connected to the ground.
- **Use an anti-static pad:** When configuring or working with an electrical component, place it on an anti-static pad. This reduces the possibility of ESD damage.
- **Only handle the edges of the electrical component:** When handling the electrical component, hold the electrical component by its edges.

### A.1.3 Product Disposal



#### CAUTION:

Risk of explosion if battery is replaced by an incorrect type. Only certified engineers should replace the on-board battery.

Dispose of used batteries according to instructions and local regulations.

- 
- Outside the European Union - If you wish to dispose of used electrical and electronic products outside the European Union, please contact your local authority so as to comply with the correct disposal method.
  - Within the European Union:



EU-wide legislation, as implemented in each Member State, requires that waste electrical and electronic products carrying the mark (left) must be

disposed of separately from normal household waste. This includes monitors and electrical accessories, such as signal cables or power cords. When you need to dispose of your display products, please follow the guidance of your local authority, or ask the shop where you purchased the product. The mark on electrical and electronic products only applies to the current European Union Member States.

Please follow the national guidelines for electrical and electronic product disposal.

## A.2 Maintenance and Cleaning Precautions

When maintaining or cleaning the TANK-860-HM86 Series, please follow the guidelines below.

### A.2.1 Maintenance and Cleaning

Prior to cleaning any part or component of the TANK-860-HM86 Series, please read the details below.

- The interior of the TANK-860-HM86 Series does not require cleaning. Keep fluids away from the TANK-860-HM86 Series interior.
- Be cautious of all small removable components when vacuuming the TANK-860-HM86 Series.
- Turn the TANK-860-HM86 Series off before cleaning the TANK-860-HM86 Series.
- Never drop any objects or liquids through the openings of the TANK-860-HM86 Series.
- Be cautious of any possible allergic reactions to solvents or chemicals used when cleaning the TANK-860-HM86 Series.
- Avoid eating, drinking and smoking within vicinity of the TANK-860-HM86 Series.

### A.2.2 Cleaning Tools

Some components in the TANK-860-HM86 Series may only be cleaned using a product specifically designed for the purpose. In such case, the product will be explicitly mentioned in the cleaning tips. Below is a list of items to use when cleaning the TANK-860-HM86 Series.

## TANK-860-HM86 Embedded System

- **Cloth** – Although paper towels or tissues can be used, a soft, clean piece of cloth is recommended when cleaning the TANK-860-HM86 Series.
- **Water or rubbing alcohol** – A cloth moistened with water or rubbing alcohol can be used to clean the TANK-860-HM86 Series.
- **Using solvents** – The use of solvents is not recommended when cleaning the TANK-860-HM86 Series as they may damage the plastic parts.
- **Vacuum cleaner** – Using a vacuum specifically designed for computers is one of the best methods of cleaning the TANK-860-HM86 Series. Dust and dirt can restrict the airflow in the TANK-860-HM86 Series and cause its circuitry to corrode.
- **Cotton swabs** - Cotton swaps moistened with rubbing alcohol or water are excellent tools for wiping hard to reach areas.
- **Foam swabs** - Whenever possible, it is best to use lint free swabs such as foam swabs for cleaning.



Appendix

**B**

# Digital I/O Interface

---

## B.1 Introduction

The DIO connector on the TANK-860-HM86 Series is interfaced to GPIO ports on the Super I/O chipset. The DIO has both 4-bit digital inputs and 4-bit digital outputs. The digital inputs and digital outputs are generally control signals that control the on/off circuit of external devices or TTL devices. Data can be read or written to the selected address to enable the DIO functions.



### NOTE:

For further information, please refer to the datasheet for the Super I/O chipset.

---

The BIOS interrupt call **INT 15H** controls the digital I/O.

### INT 15H:

AH – 6FH
<u>Sub-function:</u>
AL – 8 : Set the digital port as INPUT
AL : Digital I/O input value

### B.2 Assembly Language Sample 1

```

MOV    AX, 6F08H      ;setting the digital port as input
INT    15H            ;
    
```

**AL low byte = value**

AH – 6FH
<u>Sub-function:</u>
AL – 9 : Set the digital port as OUTPUT
BL : Digital I/O input value

### B.3 Assembly Language Sample 2

```

MOV    AX, 6F09H      ;setting the digital port as output
MOV    BL, 09H        ;digital value is 09H
INT    15H            ;
    
```

**Digital Output is 1001b**

Appendix

C

# Hazardous Materials Disclosure

---

## C.1 Hazardous Materials Disclosure Table for IPB Products Certified as RoHS Compliant Under 2002/95/EC Without Mercury

The details provided in this appendix are to ensure that the product is compliant with the Peoples Republic of China (China) RoHS standards. The table below acknowledges the presences of small quantities of certain materials in the product, and is applicable to China RoHS only.

A label will be placed on each product to indicate the estimated “Environmentally Friendly Use Period” (EFUP). This is an estimate of the number of years that these substances would “not leak out or undergo abrupt change.” This product may contain replaceable sub-assemblies/components which have a shorter EFUP such as batteries and lamps. These components will be separately marked.

Please refer to the table on the next page.



## TANK-860-HM86 Embedded System

Part Name	Toxic or Hazardous Substances and Elements					
	Lead (Pb)	Mercury (Hg)	Cadmium (Cd)	Hexavalent Chromium (CR(VI))	Polybrominated Biphenyls (PBB)	Polybrominated Diphenyl Ethers (PBDE)
Housing	X	O	O	O	O	X
Display	X	O	O	O	O	X
Printed Circuit Board	X	O	O	O	O	X
Metal Fasteners	X	O	O	O	O	O
Cable Assembly	X	O	O	O	O	X
Fan Assembly	X	O	O	O	O	X
Power Supply Assemblies	X	O	O	O	O	X
Battery	O	O	O	O	O	O

O: This toxic or hazardous substance is contained in all of the homogeneous materials for the part is below the limit requirement in SJ/T11363-2006

X: This toxic or hazardous substance is contained in at least one of the homogeneous materials for this part is above the limit requirement in SJ/T11363-2006

此附件旨在确保本产品符合中国 RoHS 标准。以下表格标示此产品中某有毒物质的含量符合中国 RoHS 标准规定的限量要求。

本产品上会附有“环境友好使用期限”的标签，此期限是估算这些物质“不会有泄漏或突变”的年限。本产品可能包含有较短的环境友好使用期限的可替换元件，像是电池或灯管，这些元件将会单独标示出来。

部件名称	有毒有害物质或元素					
	铅 (Pb)	汞 (Hg)	镉 (Cd)	六价铬 (CR(VI))	多溴联苯 (PBB)	多溴二苯 醚 (PBDE)
壳体	X	O	O	O	O	X
显示	X	O	O	O	O	X
印刷电路板	X	O	O	O	O	X
金属螺帽	X	O	O	O	O	O
电缆组装	X	O	O	O	O	X
风扇组装	X	O	O	O	O	X
电力供应组装	X	O	O	O	O	X
电池	O	O	O	O	O	O

O: 表示该有毒有害物质在该部件所有物质材料中的含量均在 SJ/T11363-2006 标准规定的限量要求以下。  
X: 表示该有毒有害物质至少在该部件的某一均质材料中的含量超出 SJ/T11363-2006 标准规定的限量要求。